

THIS DRAWING IS UNPUBLISHED. RELEASED FOR PUBLICATION
 © COPYRIGHT - By - ALL RIGHTS RESERVED.

LOC		DIST		REVISIONS			
P	LTR	DESCRIPTION		DATE	DWN	APVD	
FT	0	V		REVISED PER ECO-12-012320	04JUL12	KH	MZ

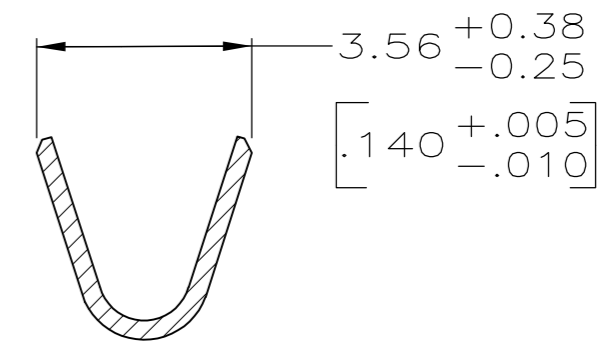

SECTION A-A

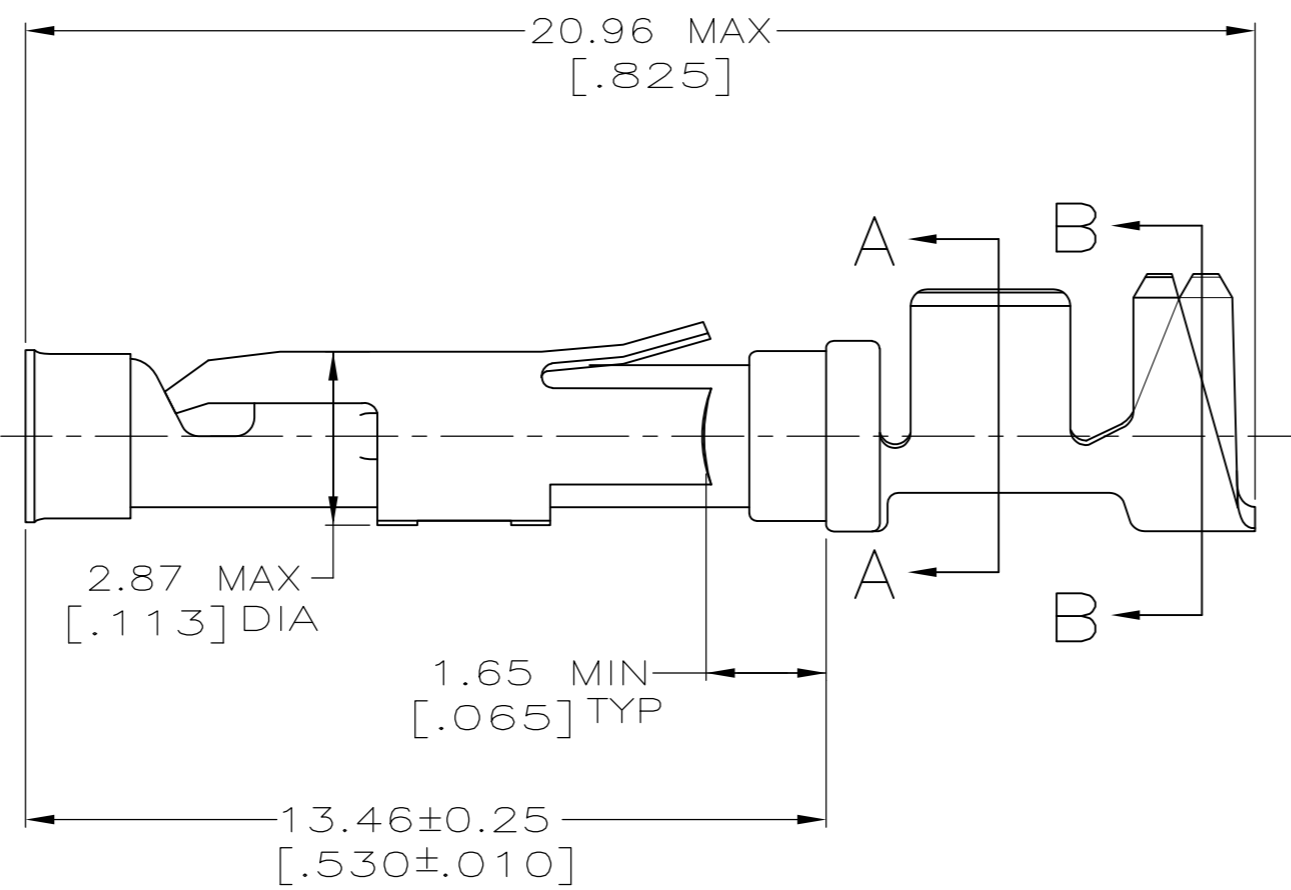
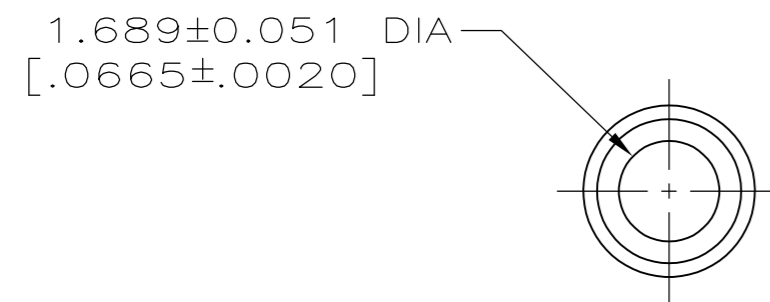
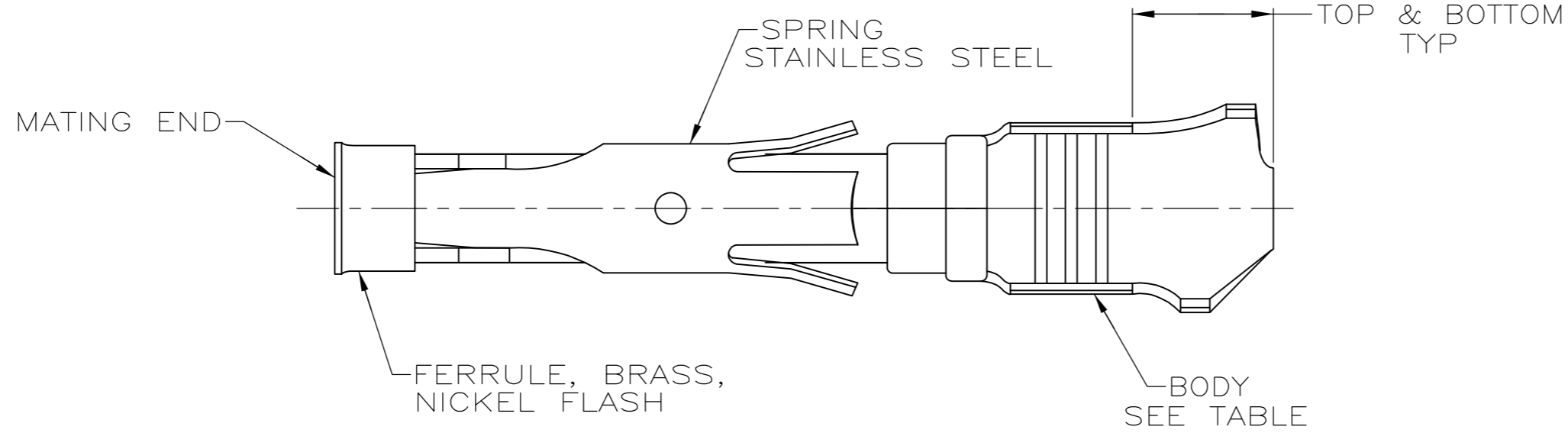
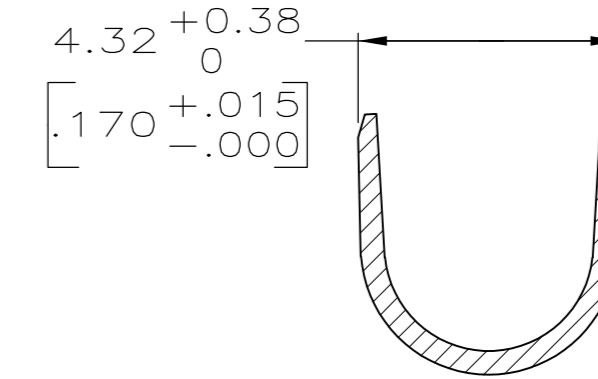

SECTION B-B

- 1 0.76µm [.000030] MIN GOLD PER MIL-G-45204 ON MATING END FOR A LENGTH OF 5.08 [.200] MIN WITH GOLD FLASH ON THE REMAINDER OVER 0.76µm [.000030] MIN NICKEL PER QQ-N-290.
- 2 1.27µm [.000050] MIN TIN-LEAD PER MIL-T-10727 OVER 0.76µm [.000030] MIN NICKEL PER QQ-N-290.
- 3 BRASS PER MIL-C-50.
- 4 PHOSPHOR BRONZE PER QQ-P-750.
- 5 GOLD PLATING NEED NOT APPEAR IN THIS AREA.
- 6 WIRE RANGE 14-18 AWG. INSULATION RANGE 2.79[.110]-3.81[.150].
- 7 0.38µm [.000015] MIN GOLD PER MIL-G-45204 ON MATING END FOR A LENGTH OF 5.08 [.200] MIN, 1.27µm [.000050] MIN TIN-LEAD PER MIL-T-10727 FOR A LENGTH OF 5.69 [.224] MIN ON OPPOSITE END, BOTH OVER 1.27µm [.000050] MIN NICKEL PER QQ-N-290 ON ENTIRE CONTACT.
- 8 1.27µm [.000050] MIN TIN PER MIL-T-10727 OVER 0.76µm [.000030] MIN NICKEL PER QQ-N-290.
- 9 CU-NI ALLOY

10 0.76µm [.000030] MIN GOLD PER MIL-G-45204 ON MATING END FOR A LENGTH OF 5.08 [.200] MIN WITH 1.27µm [.000050] MIN MATTE TIN PLATE IN WIRE CRIMP AREA, BOTH OVER 0.76µm [.000030] MIN NICKEL PER QQ-N-290.

PACKAGING	BODY FINISH	BODY MATERIAL	STRIP P/N REF	PART NO.
SMALL PACK	8	3	66598-9	1-66601-3
STANDARD	8	9	1-66598-2	1-66601-2
STANDARD	1	9	1-66598-1	1-66601-0
STANDARD	8	3	66598-9	66601-9
SMALL PACK	10	3	66598-2	66601-8
SMALL PACK	2	3	66598-1	66601-7
OBSOLETE	7	3	66598-8	66601-5
OBSOLETE	1	4	66598-6	66601-4
OBSOLETE	2	4	66598-5	66601-3
STANDARD	10	3	66598-2	66601-2
STANDARD	2	3	66598-1	66601-1

THIS DRAWING IS A CONTROLLED DOCUMENT.		DWN R.SHIREY 7-31-91		
DIMENSIONS: mm [INCHES]		CHK R.STONE 9-20-91		
TOLERANCES UNLESS OTHERWISE SPECIFIED:		APVD J.WESTMAN 9-20-91	NAME SOCKET ASSEMBLY, LOOSE PIECE, TYPE III+	
0 PLC ± - 1 PLC ± - 2 PLC ± 0.13[.005] 3 PLC ± - 4 PLC ± - ANGLES ± -		PRODUCT SPEC -	SIZE A2	
MATERIAL SEE CALLOUTS		FINISH SEE CALLOUTS	CAGE CODE 00779	DRAWING NO C-66601
CUSTOMER DRAWING		WEIGHT -	SCALE 8:1	SHEET 1 of 1

Mouser Electronics

Authorized Distributor

Click to View Pricing, Inventory, Delivery & Lifecycle Information:

[TE Connectivity:](#)

[66601-9](#)