

THIS DRAWING IS UNPUBLISHED. RELEASED FOR PUBLICATION
 © COPYRIGHT - By - ALL RIGHTS RESERVED.

LOC	DIST	REVISIONS			
P	LTR	DESCRIPTION	DATE	DWN	APVD
FT	47	E2	REVISED PER ECO-15-003583	07MAR2015	NK MZ

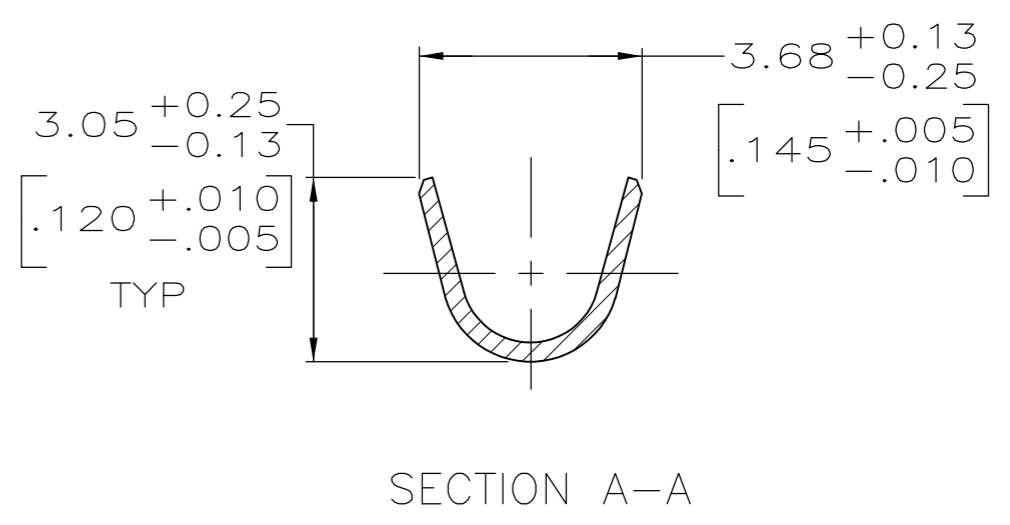
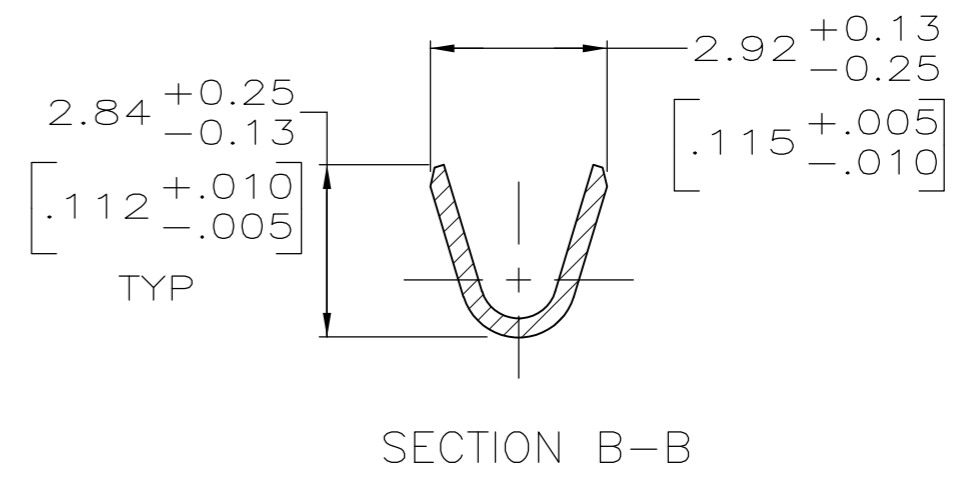
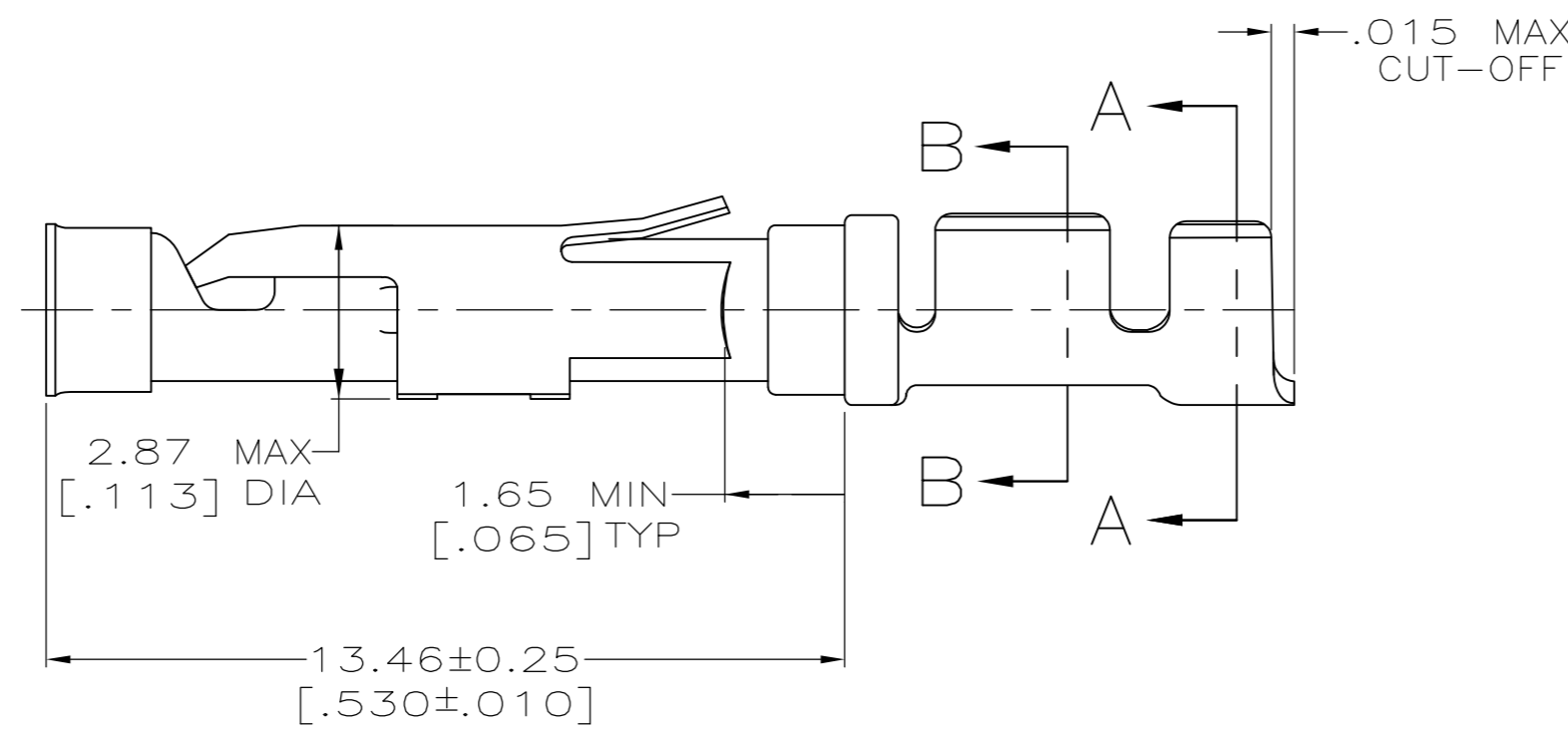
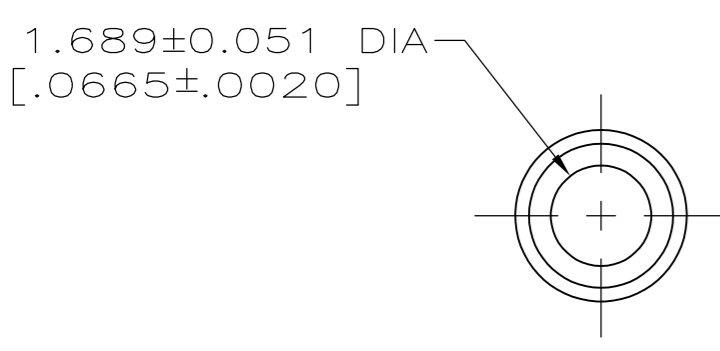
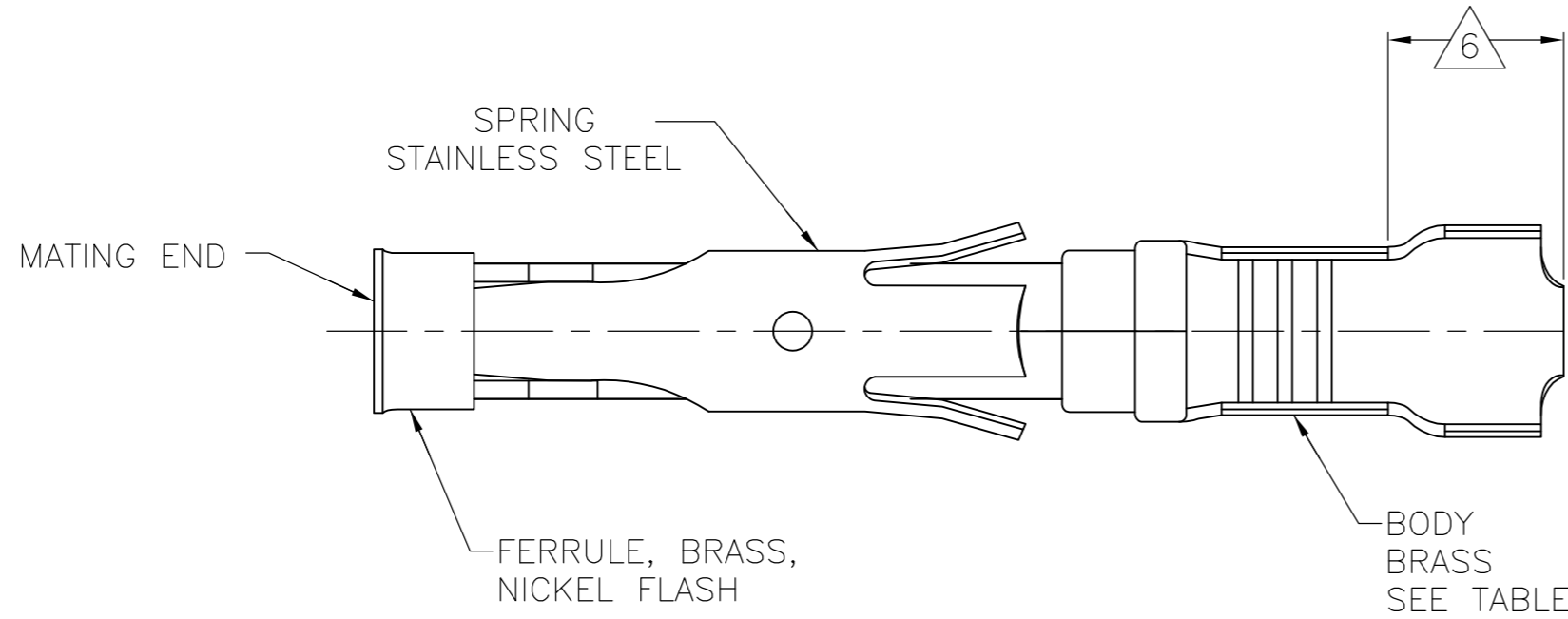

- 1 0.76µm [.000030] MIN GOLD PER MIL-G-45204 ON MATING END FOR A LENGTH OF 5.08 [.200] MIN WITH 1.27µm [.000050] MIN MATTE TIN PLATE IN WIRE CRIMP AREA, BOTH OVER 0.76µm [.000030] MIN NICKEL PER QQ-N-290.
- 2 1.27µm [.000050] MIN TIN-LEAD PER MIL-T-10727 OVER 0.76µm [.000030] MIN NICKEL PER QQ-N-290.
- 3 0.76µm [.000030] MIN GOLD PER MIL-G-45204 ON MATING END FOR A LENGTH OF 5.08 [.200] MIN WITH A UNIFORM GRADIENT TO 0.25µm [.000010] MIN GOLD PER MIL-G-45204 ON THE REMAINDER OVER 0.76µm [.000030] MIN NICKEL PER QQ-N-290.
- 4 0.38µm [.000015] MIN GOLD PER MIL-G-45204 ON MATING END FOR A LENGTH OF 5.08 [.200] MIN WITH 1.27µm [.000050] MIN MATTE TIN PLATE IN WIRE CRIMP AREA, BOTH OVER 0.76µm [.000030] MIN NICKEL PER QQ-N-290.
- 5 0.38µm [.000015] MIN GOLD PER MIL-G-45204 ON MATING END FOR A LENGTH OF 5.08 [.200] MIN, 1.27µm [.000050] MIN TIN-LEAD PER MIL-T-10727 FOR A LENGTH OF 5.69 [.224] MIN ON OPPOSITE END, BOTH OVER 1.27µm [.000050] MIN NICKEL PER QQ-N-290 ON ENTIRE CONTACT.
- 6 GOLD PLATING NOT REQUIRED IN THIS AREA.
- 7 ALL CONTACTS ON THIS DRAWING CAPABLE OF BE USED WITH:
 A WIRE RANGE OF 18-16 AWG WITH AN INSULATION RANGE OF Ø2.03-2.54 [.080-.100] OR
 A WIRE SIZE OF 0.75mm² WITH AN INSULATION RANGE OF Ø1.35-1.65 [.053-.065] OR
 A WIRE SIZE OF 1.0mm² WITH AN INSULATION RANGE OF Ø1.45-1.80 [.057-.071]
- 8 1.27µm [.000050] MIN TIN PER MIL-T-10727 OVER 0.76µm [.000030] MIN NICKEL PER QQ-N-290.

SUPERCEDED BY 66101-3

PACKAGING TYPE	BODY	STRIP P/N	PART NO
SMALL PACK	8	1-66100-9 OR 2-66100-0	2-66101-0
STANDARD	8	1-66100-9 OR 2-66100-0	1-66101-9
SMALL PACK	1	66100-4	1-66101-8
SMALL PACK	4	66100-3	1-66101-7
SMALL PACK	2	66100-2	1-66101-6
SMALL PACK	3	66100-1	1-66101-5
STANDARD	5	1-66100-7	1-66101-4
STANDARD	1	66100-4	66101-4
STANDARD	4	66100-3	66101-3
STANDARD	2	66100-2	66101-2
STANDARD	3	66100-1	66101-1

THIS DRAWING IS A CONTROLLED DOCUMENT.

DWN 05/29/92
 L.SIPE
 CHK 6-11-92
 W.LENKER
 APVD 7-7-92
 G.STEINHAUER
 PRODUCT SPEC

TE Connectivity

SOCKET ASSEMBLY, LOOSE PIECE, TYPE III+

SIZE A2 CAGE CODE 00779 DRAWING NO C-66101 RESTRICTED TO

MATERIAL SEE CALLOUTS FINISH SEE CALLOUTS WEIGHT - SCALE 8:1 SHEET 1 OF 1 REV E2

CUSTOMER DRAWING

Mouser Electronics

Authorized Distributor

Click to View Pricing, Inventory, Delivery & Lifecycle Information:

[TE Connectivity:](#)

[66101-3](#)