

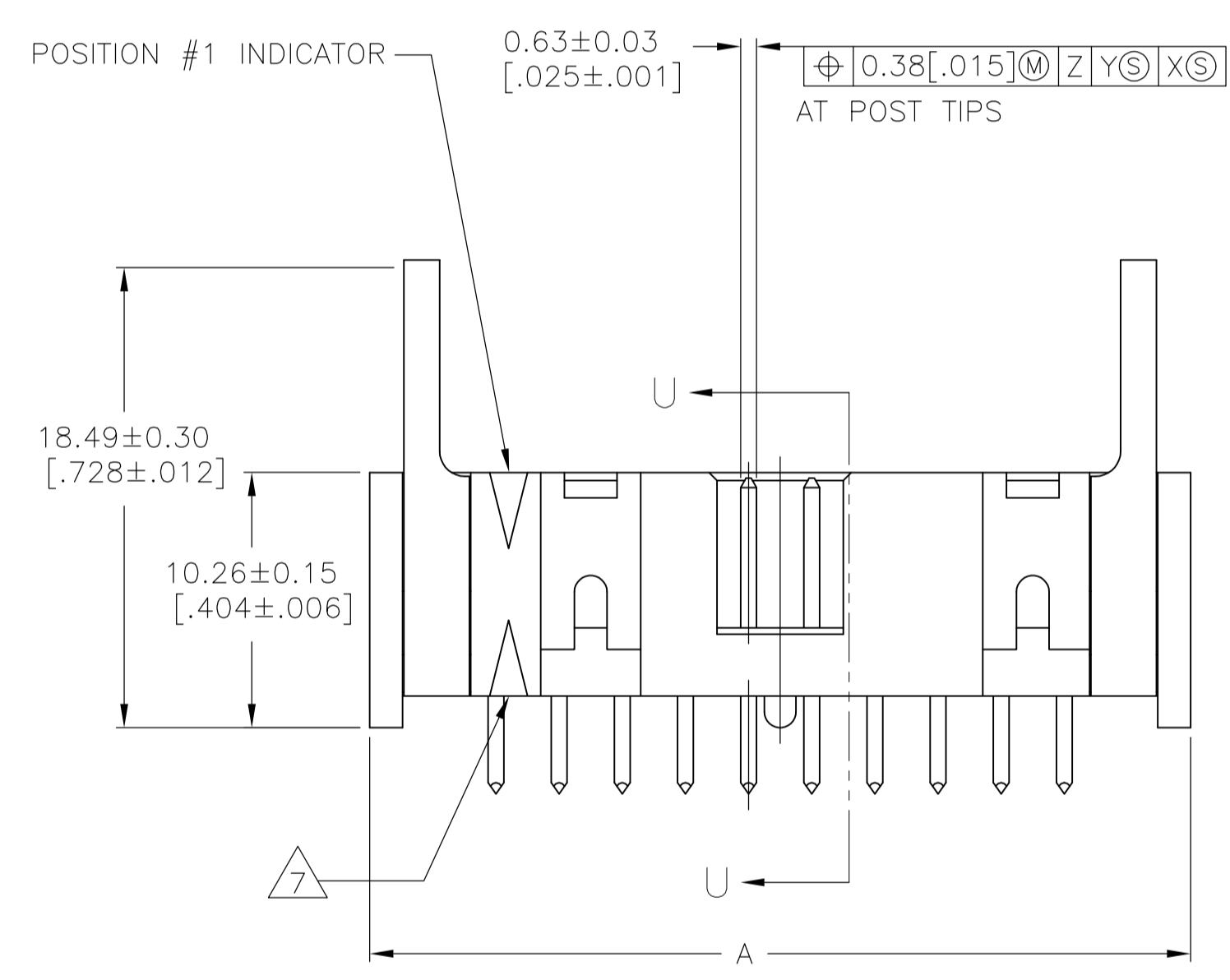

- ① HOUSING: PBT, UL94V-0, COLOR: (SEE TABLE).
POSTS: PHOSPHOR BRONZE.
LATCHES: ZINC ALLOY.
- ② POSTS: GOLD FLASH OVER PALLADIUM-NICKEL PLATE, 0.76µm[.000030] MIN TOTAL ON MATING AREA, 2.54µm[.000100] MIN TIN PLATE ON SOLDER-TAIL, ALL OVER 1.27µm[.000050] MIN NICKEL UNDERPLATE ON ENTIRE POST.
OR
0.76µm[.000030] MIN GOLD PLATE ON MATING AREA, 2.54µm[.000100] MIN TIN PLATE ON THE SOLDER-TAIL, 1.27µm[.000050] MIN NICKEL UNDERPLATE ON THE ENTIRE POST.
LATCHES: BLACK NICKEL OVER COPPER.
- ③ DATUMS S & T TO BE ESTABLISHED BY CUSTOMER.
- ④ NO KEYING SLOT ON THIS END FOR 6, 8, 10 & 14 POSITION ASSEMBLIES.
- ⑤ NO KEYING SLOT ON THIS END FOR 6, 8 & 10 POSITION ASSEMBLIES.
- ⑥ NO STANDOFF FOR 6, 10, 14 & 16 POSITION ASSEMBLIES.
- ⑦ ALTERNATE LOCATION/ORIENTATION FOR POSITION #1 INDICATOR.



RECOMMENDED PC BOARD LAYOUT (VIEWED FROM CONNECTOR SIDE)

HOUSING COLOR	E	D	C	B	A	NO OF POS	PART NUMBER	
OBSOLETE	78.74 [3.100]	31	80.77 [3.180]	86.26 [3.396]	88.90 [3.500]	64	3-1761608-7	
	73.66 [2.900]	29	75.69 [2.980]	81.18 [3.196]	83.82 [3.300]	60	3-1761608-6	
	60.96 [2.400]	24	62.99 [2.480]	68.48 [2.696]	71.12 [2.800]	50	3-1761608-5	
	53.34 [2.100]	21	55.37 [2.180]	60.86 [2.396]	63.50 [2.500]	44	3-1761608-4	
	48.26 [1.900]	19	50.29 [1.980]	55.78 [2.196]	58.42 [2.300]	40	3-1761608-3	
	43.18 [1.700]	17	45.21 [1.780]	50.70 [1.996]	53.34 [2.100]	36	3-1761608-2	
	40.64 [1.600]	16	42.67 [1.680]	48.16 [1.896]	50.80 [2.000]	34	3-1761608-1	
	35.56 [1.400]	14	37.59 [1.480]	43.08 [1.696]	45.72 [1.800]	30	3-1761608-0	
	BLUE	30.48 [1.200]	12	32.51 [1.280]	38.00 [1.496]	40.64 [1.600]	26	2-1761608-9
		27.94 [1.100]	11	29.97 [1.180]	35.46 [1.396]	38.10 [1.500]	24	2-1761608-8
22.86 [0.900]		9	24.89 [0.980]	30.38 [1.196]	33.02 [1.300]	20	2-1761608-7	
17.78 [0.700]		7	19.81 [0.780]	25.30 [0.996]	27.94 [1.100]	16	2-1761608-6	
15.24 [0.600]		6	17.27 [0.680]	22.76 [0.896]	25.40 [1.000]	14	2-1761608-5	
10.16 [0.400]		4	12.19 [0.480]	17.68 [0.696]	20.32 [0.800]	10	2-1761608-3	
OBSOLETE		7.62 [0.300]	3	9.65 [0.380]	15.14 [0.596]	17.78 [0.700]	8	2-1761608-2
		5.08 [0.200]	2	7.11 [0.280]	12.60 [0.496]	15.24 [0.600]	6	2-1761608-1
		73.66 [2.900]	29	75.69 [2.980]	81.18 [3.196]	83.82 [3.300]	60	1-1761608-6
		60.96 [2.400]	24	62.99 [2.480]	68.48 [2.696]	71.12 [2.800]	50	1-1761608-5
	48.26 [1.900]	19	50.29 [1.980]	55.78 [2.196]	58.42 [2.300]	40	1-1761608-3	
	40.64 [1.600]	16	42.67 [1.680]	48.16 [1.896]	50.80 [2.000]	34	1-1761608-1	
	35.56 [1.400]	14	37.59 [1.480]	43.08 [1.696]	45.72 [1.800]	30	1-1761608-0	
	OBSOLETE	30.48 [1.200]	12	32.51 [1.280]	38.00 [1.496]	40.64 [1.600]	26	1761608-9
		27.94 [1.100]	11	29.97 [1.180]	35.46 [1.396]	38.10 [1.500]	24	1761608-8
		22.86 [0.900]	9	24.89 [0.980]	30.38 [1.196]	33.02 [1.300]	20	1761608-7
17.78 [0.700]		7	19.81 [0.780]	25.30 [0.996]	27.94 [1.100]	16	1761608-6	
15.24 [0.600]		6	17.27 [0.680]	22.76 [0.896]	25.40 [1.000]	14	1761608-5	
10.16 [0.400]		4	12.19 [0.480]	17.68 [0.696]	20.32 [0.800]	10	1761608-3	

THIS DRAWING IS A CONTROLLED DOCUMENT.

APPROVED: B. CRISAMORE/DJI, S. BOLASH, M. WALMSLEY

NAME: M. WALMSLEY

PRODUCT SPEC: HEADER ASSEMBLY, SHORT EJECT LATCH, VERTICAL, LOW PROFILE, IDC

APPLICATION SPEC: ---

SIZE: A1, CAGE CODE: 00779, DRAWING NO: 1761608

RESTRICTED TO: ---

MATERIAL: ---, FINISH: ---, WEIGHT: ---

CUSTOMER DRAWING: ---, SCALE: 4:1, SHEET: 1 OF 1, REV: F1

Mouser Electronics

Authorized Distributor

Click to View Pricing, Inventory, Delivery & Lifecycle Information:

[TE Connectivity:](#)

[3-1761608-5](#)