

- 1 MATERIAL: POLYESTER, BLACK.
- 2 OBSOLETE PART NUMBER.
- 3 OBSOLETE PARTS: OBSOLETE CIS STREAMLINING PER D.RENAUD/D.SINISI

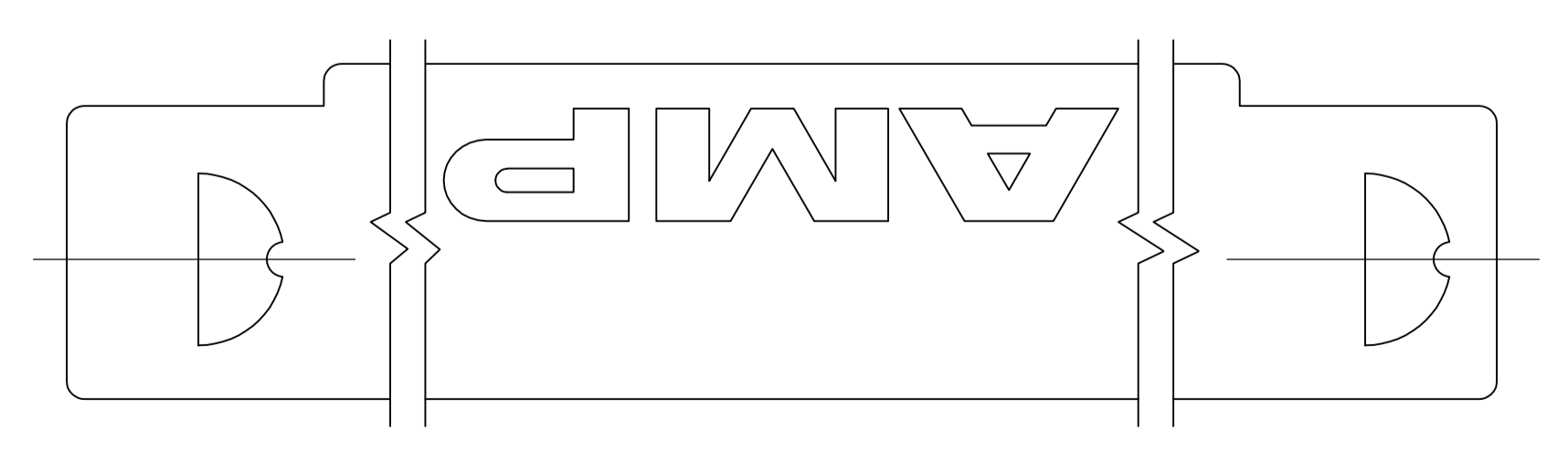
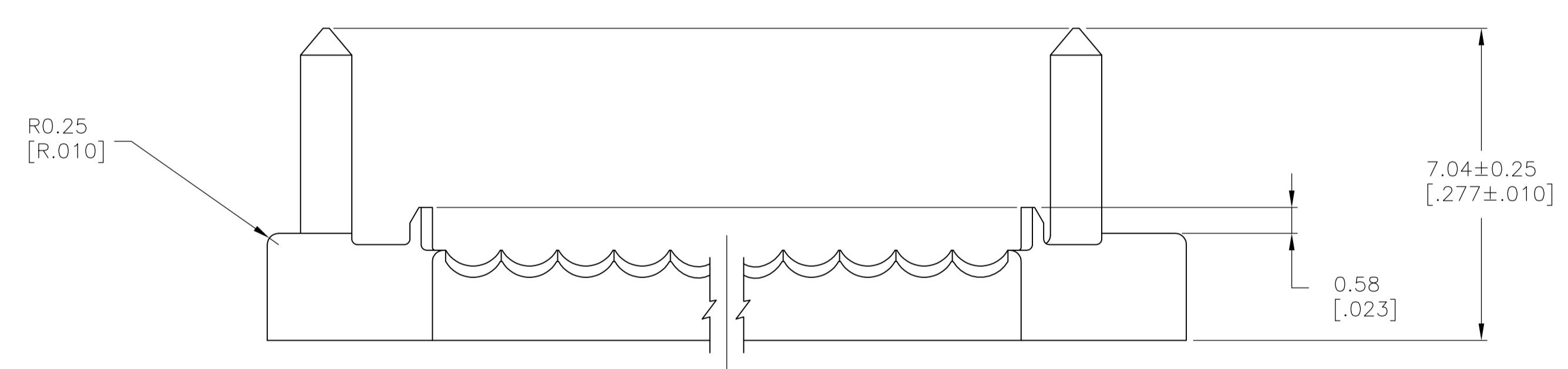
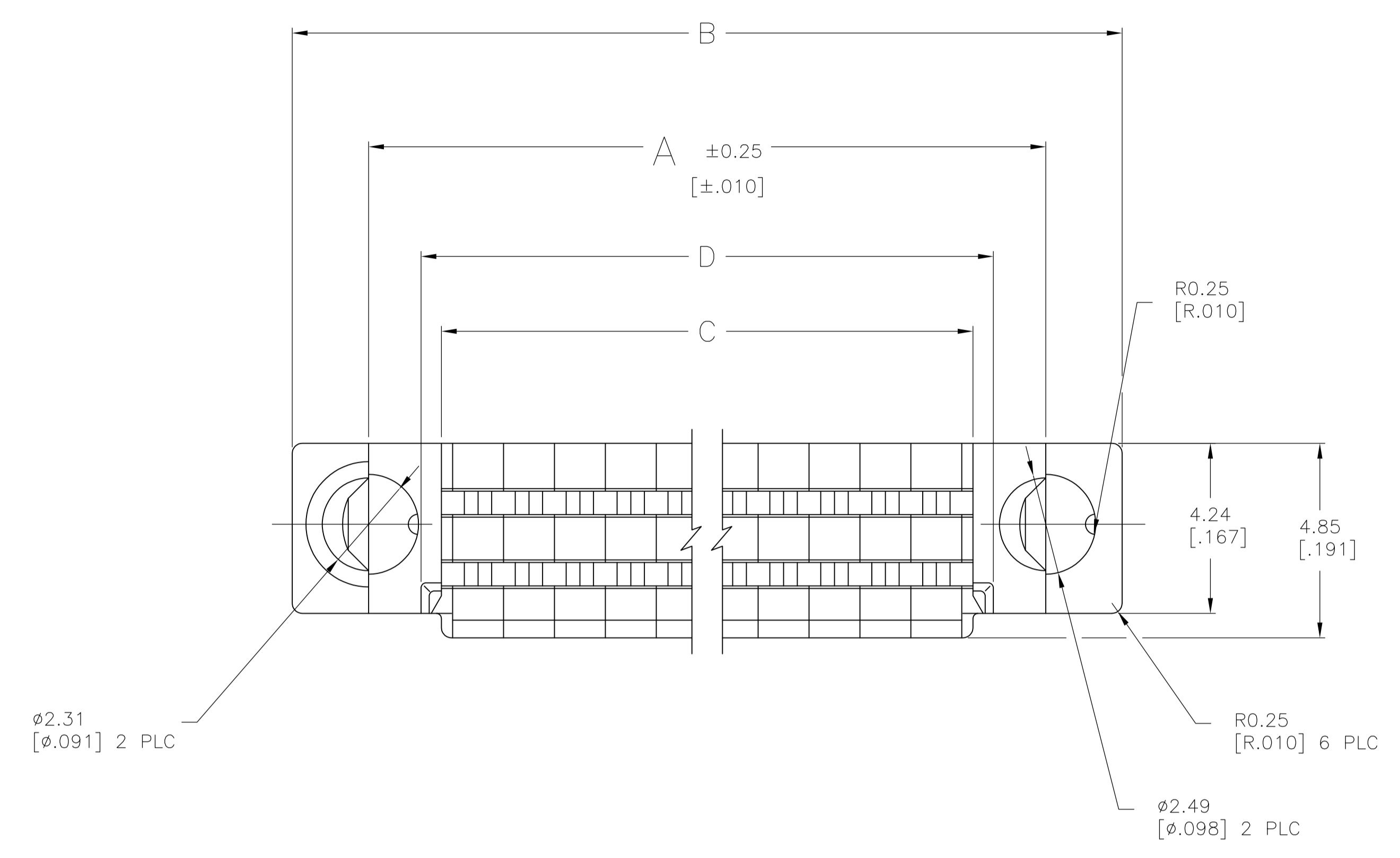

2	44.76	43.74	51.18	47.37	68	1-104891-1
	[1.762]	[1.722]	[2.015]	[1.865]		
100	65.08	64.06	71.50	67.69	100	1-104891-0
	[2.562]	[2.522]	[2.815]	[2.665]		
3	58.73	57.71	65.15	61.34	90	104891-9
	[2.312]	[2.272]	[2.565]	[2.415]		
80	52.38	51.36	58.80	54.99	80	104891-8
	[2.062]	[2.022]	[2.315]	[2.165]		
70	46.03	45.01	52.45	48.64	70	104891-7
	[1.812]	[1.772]	[2.065]	[1.915]		
60	39.68	38.66	46.10	42.29	60	104891-6
	[1.562]	[1.522]	[1.815]	[1.665]		
50	33.33	32.31	39.75	35.94	50	104891-5
	[1.312]	[1.272]	[1.565]	[1.415]		
40	26.98	25.96	33.82	29.59	40	104891-4
	[1.062]	[1.022]	[1.315]	[1.165]		
30	20.63	19.61	27.05	23.24	30	104891-3
	[.812]	[.772]	[1.065]	[.915]		
20	14.28	13.26	20.70	16.89	20	104891-2
	[.562]	[.522]	[.815]	[.665]		
10	7.92	6.91	14.35	10.54	10	104891-1
	[.312]	[.272]	[.565]	[.415]		
	D	C	B	A	NO OF POSN	PART NUMBER

THIS DRAWING IS A CONTROLLED DOCUMENT.		DIN L. CASTAGNA 23JUN93		TE Connectivity	
DIMENSIONS: mm [INCHES]		TOLERANCES UNLESS OTHERWISE SPECIFIED:			
0 PLC ± -		1 PLC ± -		APVD J. HERRINGTON 24JUN93	
1 PLC ± -		2 PLC ± 0.36[.015]		NAME	
2 PLC ± -		3 PLC ± -		PRODUCT SPEC	
3 PLC ± -		4 PLC ± -		108-1443	
4 PLC ± -		ANGLES ± -		APPLICATION SPEC	
MATERIAL		FINISH		114-7010	
1		-		SIZE CAGE CODE DRAWING NO	
				A1 00779 C=104891	
				RESTRICTED TO	
				CUSTOMER DRAWING	
				SCALE 10:1 SHEET 1 OF 1 REV C2	

Mouser Electronics

Authorized Distributor

Click to View Pricing, Inventory, Delivery & Lifecycle Information:

[TE Connectivity:](#)

[104891-7](#)