

THIS DRAWING IS UNPUBLISHED. RELEASED FOR PUBLICATION  
 © COPYRIGHT - By - ALL RIGHTS RESERVED.

LOC		DIST		REVISIONS				
P	LTR	DESCRIPTION			DATE	DWN	APVD	
AD	00	F3	REVISED PER ECO-11-010839			25MAY11	RK	HMR

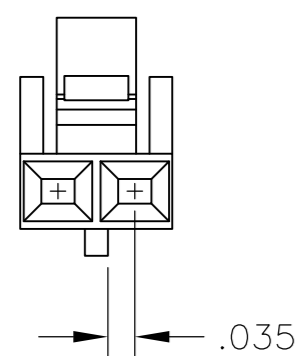

1 MATERIAL: FLAME RETARDANT THERMOPLASTIC, COLOR- BLACK.  
 2 THIS DIMENSION .480 FOR 2 POSN ONLY

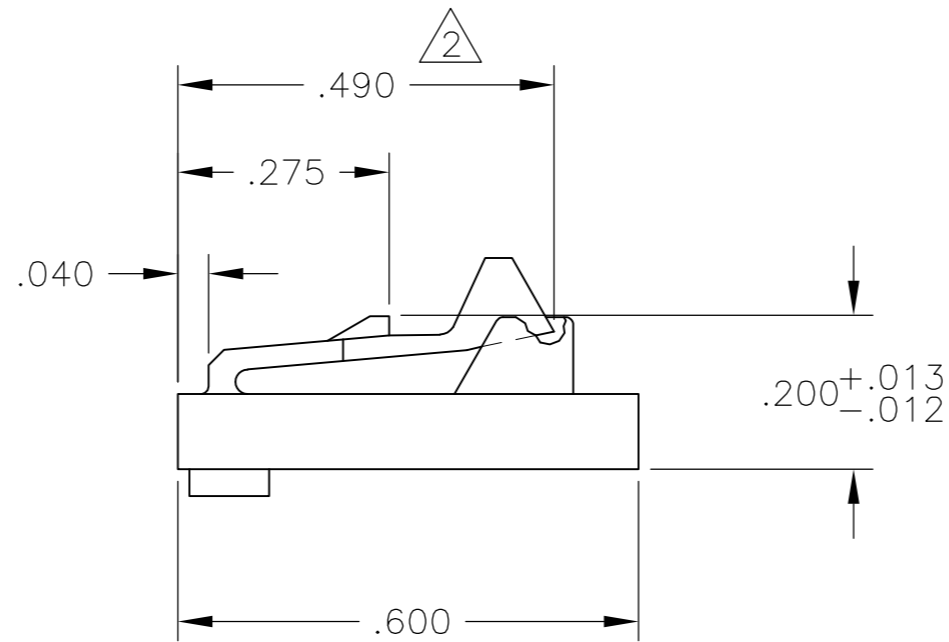
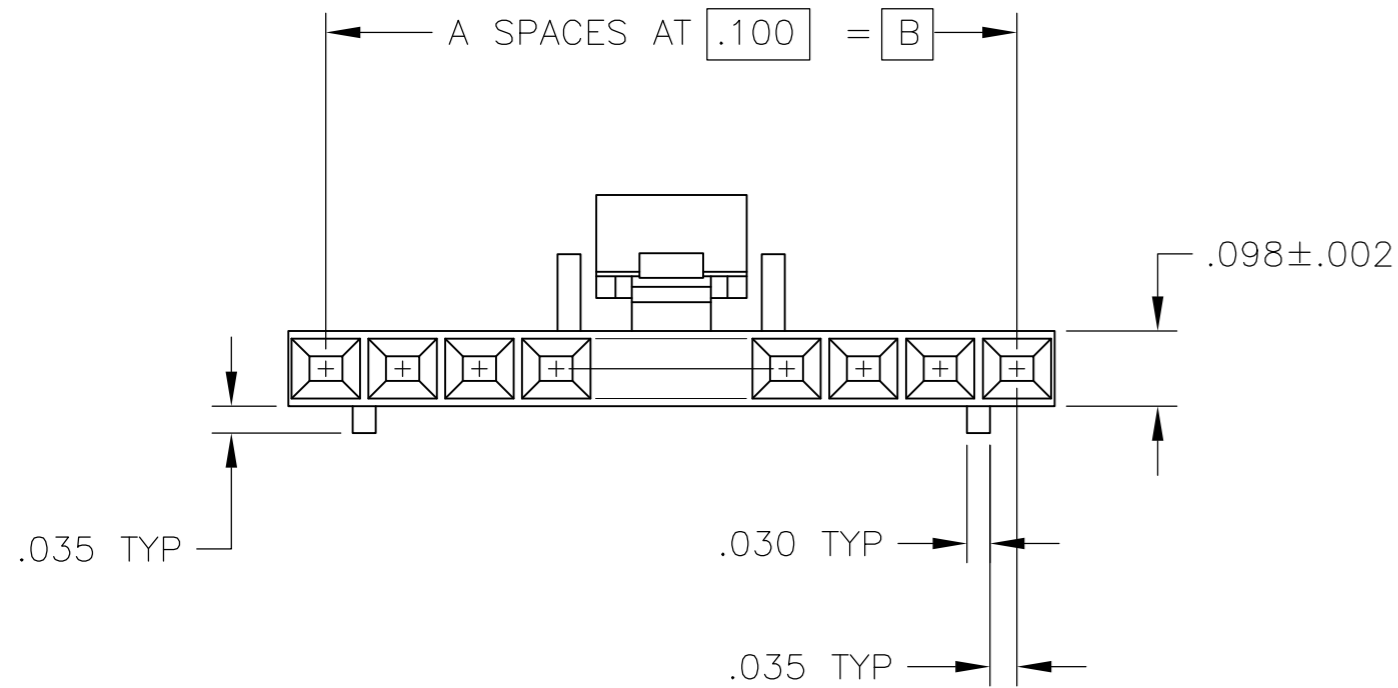

DETAIL FOR -1 ONLY  
(2 POSITION)

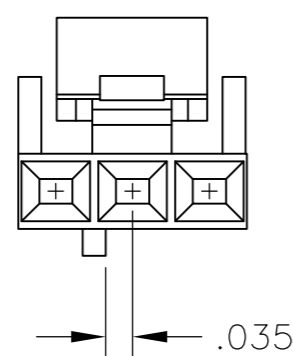

DETAIL FOR -2 ONLY  
(3 POSITION)

2.498	2.400	24	25	2-104257-4
2.398	2.300	23	24	2-104257-3
2.298	2.200	22	23	2-104257-2
2.198	2.100	21	22	2-104257-1
2.098	2.000	20	21	2-104257-0
1.998	1.900	19	20	1-104257-9
1.898	1.800	18	19	1-104257-8
1.798	1.700	17	18	1-104257-7
1.698	1.600	16	17	1-104257-6
1.598	1.500	15	16	1-104257-5
1.498	1.400	14	15	1-104257-4
1.398	1.300	13	14	1-104257-3
1.298	1.200	12	13	1-104257-2
1.198	1.100	11	12	1-104257-1
1.098	1.000	10	11	1-104257-0
.998	.900	9	10	104257-9
.898	.800	8	9	104257-8
.798	.700	7	8	104257-7
.698	.600	6	7	104257-6
.598	.500	5	6	104257-5
.498	.400	4	5	104257-4
.398	.300	3	4	104257-3
.298	.200	2	3	104257-2
.198	.100	1	2	104257-1
C	B	A	NO OF POSN	PART NUMBER

THIS DRAWING IS A CONTROLLED DOCUMENT.		DWN	R BROWN	02FEB2006
DIMENSIONS: INCHES		CHK	J GESFORD	02FEB2006
TOLERANCES UNLESS OTHERWISE SPECIFIED:		APVD	J GESFORD	02FEB2006
0 PLC	± -	NAME		
1 PLC	± -	RECEPTACLE HOUSING, AMPMODU		
2 PLC	± -	MTE, SINGLE ROW, .100CL		
3 PLC	± .005	POLARIZED WITH LATCH		
4 PLC	± -	PRODUCT SPEC	108-25034	
ANGLES	± -	APPLICATION SPEC	114-25026	
FINISH	-	WEIGHT	-	
MATERIAL		CUSTOMER DRAWING		
1		SIZE	A2	CAGE CODE
		00779		DRAWING NO
		C=104257		RESTRICTED TO
		SCALE	4:1	SHEET
		1 OF 1		REV
				F3

# Mouser Electronics

Authorized Distributor

Click to View Pricing, Inventory, Delivery & Lifecycle Information:

[TE Connectivity:](#)

[1-104257-3](#)