

HTM1735LF – Temperature and Relative Humidity Module

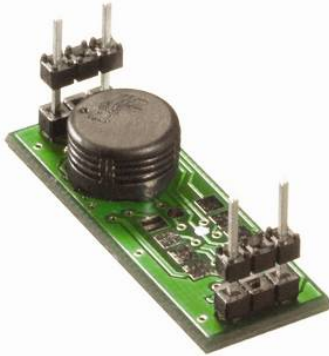

- Suitable for direct board assembly
- Product free from Lead, Cr (6+), Cd and Hg
- Humidity calibrated within +/- 2% RH @ 55% RH
- Typical 1 to 3.6 Volt DC output for 0 to 100% RH at 5V DC supply
- Temperature measurement through NTC 10 kΩ +/- 3% direct output



DESCRIPTION

Based on the rugged HS1101LF humidity sensor, HTM1735LF is a dedicated humidity and temperature transducer designed for OEM applications where a reliable and accurate measurement is needed. Direct interface with a micro-controller is made possible with the module's humidity linear voltage and direct NTC outputs. HTM1735LF is designed for an optimized board to board connection.

FEATURES

- Full interchangeability
- High reliability and long term stability
- Not affected by repeated condensations
- Ratiometric to voltage supply within the specified range

APPLICATIONS

- Reprography
- HVAC Controller
- ...

PERFORMANCE SPECS

MAXIMUM RATINGS

Ratings	Symbol	Value	Unit
Storage Temperature	Tstg	-40 to 105	°C
Storage Humidity	RHstg	0 to 100	% RH
Supply Voltage (Peak)	Vs	7	Vdc
Humidity Operating Range	RH	0 to 100	% RH
Temperature Operating Range	Ta	-40 to 100	°C
Maximum Output Current (Peak)	I _{Peak}	5	mA
Maximum Power	Pd	20	mW

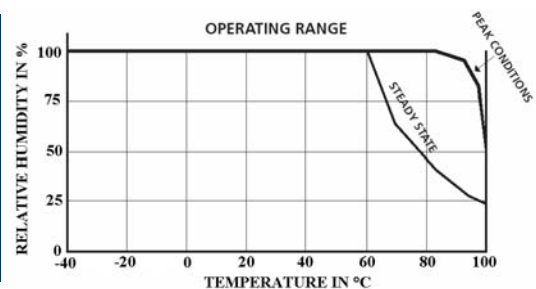

HTM1735LF – Temperature and Relative Humidity Module

ELECTRICAL CHARACTERISTICS

(Ta=25°C, Vs=5Vdc, RL>1MΩ unless otherwise stated)

Humidity Characteristics	Symbol	Min	Typ	Max	Unit
Humidity Measuring Range	RH	0		100	%RH
Relative Humidity Accuracy (10 to 95% RH)	RH		+/-3	+/-5	%RH
Supply Voltage	Vs	4.75	5.00	5.25	Vdc
Nominal Output @55%RH (at 5Vdc)	Vout	2.42	2.48	2.54	V
Current Consumption	Ic		2.8	4	mA
Temperature Coefficient (10 to 50°C)	Tcc		-0.05	-0.1	%RH/°C
Average Sensitivity from 33% to 75%RH	$\Delta V_{out}/\Delta RH$		+26		mV/%RH
Sink Current Capability (RL = 33kΩ)	I			150	μA
Recovery Time after 150 hours of condensation	tr		10		s
Humidity Hysteresis			+/-1		%RH
Humidity Resolution			0.4		%RH
Long Term Stability	T		+/-0.5		%RH/yr
Time Constant (at 63% of signal, static) 33% to 75%RH ⁽¹⁾	τ		5	10	s
Output Impedance	Z		70		Ω
Warm Up Time	t _w		200		ms

⁽¹⁾ At 2m/s air flow

(Ta=25°C)

Temperature Characteristics	Symbol	Min	Typ	Max	Unit
Nominal Resistance @25°C	R		10		kΩ
Beta value: B25/100	β	3600	3730	3800	
Temperature Measuring Range	Ta	-30		80	°C
Nominal Resistance Tolerance @25°C	R _N		2	3	%
Beta Value Tolerance	β		3		%
Response Time	τ		10		s

TYPICAL PERFORMANCE CURVES

HUMIDITY SENSOR

- Measurement Conditions

HTM1735LF is specified for accurate measurements within 10 to 95 %RH.

Excursion out of this range (< 10% or > 95% RH, including condensation) does not affect the reliability of HTM1735LF characteristics

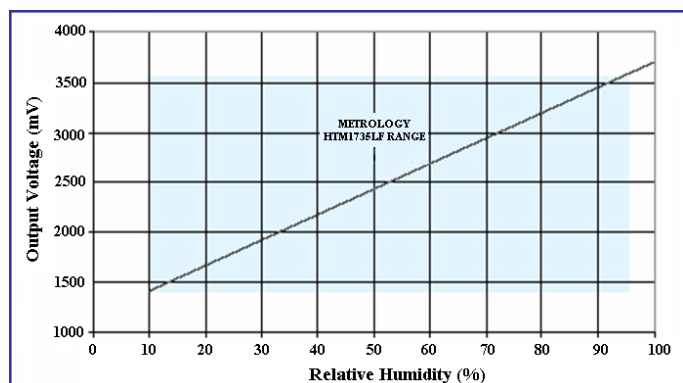

HTM1735LF – Temperature and Relative Humidity Module

- HTM1735LF Modeled Linear Voltage Output (Vcc=5V)

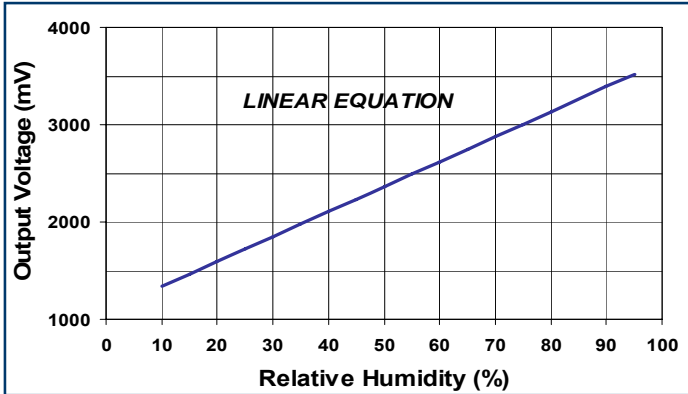

RH (%)	Vout (mV)	RH (%)	Vout (mV)
10	1325	55	2480
15	1465	60	2605
20	1600	65	2730
25	1735	70	2860
30	1860	75	2990
35	1990	80	3125
40	2110	85	3260
45	2235	90	3405
50	2360	95	3555

LINEAR EQUATION:

- $V_{out} = 25.68RH + 1079$
 - $RH = 0.03892 V_{out} - 41.98$
- (With V_{out} in mV and RH in %)

- Error Budget Conditions

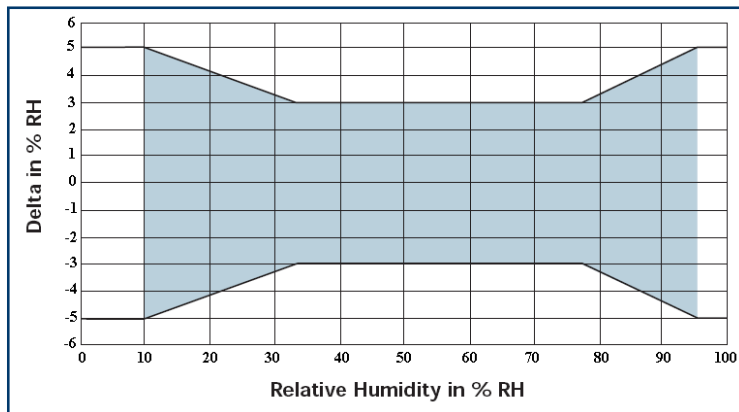

- Linearity Error

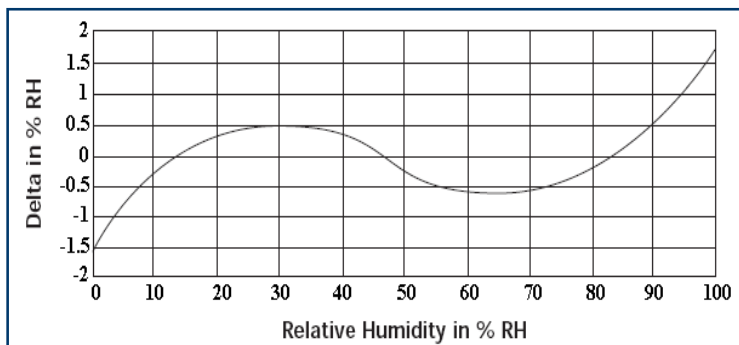

HTM1735LF – Temperature and Relative Humidity Module

TEMPERATURE SENSOR

- Typical temperature output

Depending on the needed temperature measurement range and associated accuracy, we suggest two methods to access to the NTC resistance values.

$$R_T = R_N \times e^{\beta \left(\frac{1}{T} - \frac{1}{T_N} \right)}$$

R_T NTC resistance in Ω at temperature T in K
 R_N NTC resistance in Ω at rated temperature T in K
 T, T_N Temperature in K
 β Beta value, material specific constant of NTC
 e Base of natural logarithm ($e=2.71828$)

① The exponential relation only roughly describes the actual characteristic of an NTC thermistor can, however, as the material parameter β in reality also depend on temperature. So this approach is suitable for describing a restricted range around the rated temperature or resistance with sufficient accuracy.

② For practical applications, a more precise description of the real R/T curve may be required. Either more complicated approaches (e.g. the Steinhart-Hart equation) are used or the resistance/temperature relation as given in tabulation form. The below table has been experimentally determined with utmost accuracy for temperature increments of 1 degree.

Actual values may also be influenced by inherent self-heating properties of NTCs. Please refer to MEAS-France Application Note HPC106 “Low power NTC measurement”.

- Temperature look-up table

Temp (°C)	Resistance (Ω)	Max Deviation (Ω)	Temp (°C)	Resistance (Ω)	Max Deviation (Ω)	Temp (°C)	Resistance (Ω)	Max Deviation (Ω)	Temp (°C)	Resistance (Ω)	Max Deviation (Ω)
-30	144790	16636	-2	33100	2230	26	9600	300	54	3360	213
-29	136664	15444	-1	31557	2078	27	9218	300	55	3237	208
-28	129054	14343	0	30029	1932	28	8853	299	56	3126	204
-27	121925	13325	1	28627	1799	29	8506	297	57	3019	200
-26	115243	12383	2	27299	1675	30	8178	296	58	2917	197
-25	109030	11516	3	26042	1560	31	7866	294	59	2819	193
-24	103115	10705	4	24852	1452	32	7568	292	60	2720	189
-23	97565	9953	5	23773	1355	33	7283	290	61	2629	185
-22	92354	9257	6	22708	1261	34	7011	287	62	2542	182
-21	87460	8612	7	21698	1174	35	6734	284	63	2458	178
-20	82923	8020	8	20739	1093	36	6484	281	64	2378	175
-19	78581	7463	9	19829	1017	37	6244	278	65	2304	171
-18	74497	6947	10	18959	946	38	6015	275	66	2229	168
-17	70655	6468	11	18128	879	39	5796	271	67	2158	165
-16	67039	6023	12	17338	817	40	5575	267	68	2089	161
-15	63591	5606	13	16588	759	41	5373	264	69	2022	158
-14	60381	5222	14	15876	705	42	5180	260	70	1960	155
-13	57356	4865	15	15207	654	43	4995	257	71	1898	152
-12	54503	4533	16	14569	607	44	4817	253	72	1839	149
-11	51813	4225	17	13962	563	45	4636	248	73	1782	146
-10	49204	3932	18	13384	522	46	4473	245	74	1727	143
-9	46767	3662	19	12834	484	47	4316	241	75	1673	140
-8	44467	3411	20	12280	447	48	4166	237	76	1622	138
-7	42296	3177	21	11777	413	49	4021	233	77	1573	135
-6	40247	2960	22	11297	382	50	3874	229	78	1526	132
-5	38279	2756	23	10840	353	51	3737	225	79	1480	130
-4	36455	2568	24	10404	325	52	3606	221	80	1432	127
-3	34731	2393	25	10000	300	53	3481	217			

HTM1735LF – Temperature and Relative Humidity Module

QUALIFICATION PROCESS

RESISTANCE TO PHYSICAL AND CHEMICAL STRESSES

- HTM1735LF has passed through qualification processes of MEAS-France including vibration, shock, storage, high temperature and humidity.
- HTM1735LF contains circuit to protect its inputs and outputs against ElectroStatic Discharges (ESD) up to $\pm 15\text{kV}$, air discharge.
- Additional tests under harsh chemical conditions demonstrate good operation in presence of salt atmosphere, SO₂ (0.5%), H₂S (0.5%), O₃, NO_x, NO, CO, CO₂, Softener, Soap, Toluene, acids (H₂SO₄, HNO₃, HCl), HMDS, Insecticide, Cigarette smoke, this is not an exhaustive list.
- HTM1735LF is not light sensitive.

SPECIFIC PRECAUTIONS

- HTM1735LF is not protected against reversed polarity - Check carefully when connecting the device.

PACKAGE OUTLINE

PINOUT ASSIGNMENT

Pin	Function
1	NTC – Temperature
2	Ground
3	Vcc – Voltage supply
4	Vout – Humidity

HTM1735LF STD PACKAGE OUTLINE

Package Outline

Dim	Min (mm)	Max (mm)
A	34	36
B	12.5	13.5
C	30.25 Typ	
D	5.08 Typ	
E	13.1 Typ	

Footprint Outline

Dim	Min (mm)	Max (mm)
A	34	36
B	12.5	13.5
D	5.08 Typ	
F	2.36 Typ	
G	3.94 Typ	
H	$\varnothing 1.02$ Typ	

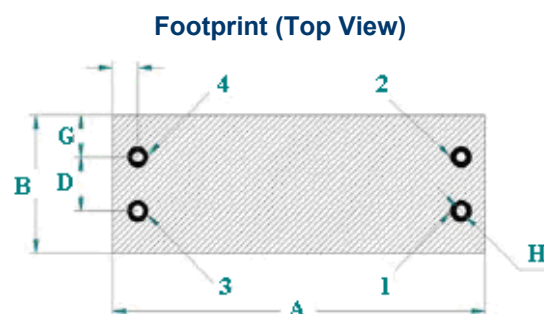
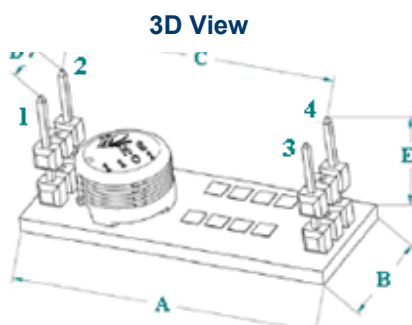

HTM1735LF – Temperature and Relative Humidity Module

HTM1735LF SMD PACKAGE OUTLINE

Package Outline

Dim	Min (mm)	Max (mm)
A	34	36
B	12.5	13.5
C	30.25 Typ	
D	5.08 Typ	
E	6.65 Typ	

Footprint Outline

Dim	Min (mm)	Max (mm)
F	27.81Typ	
G	1.27 Typ	
H	3.33 Typ	
J	2.04 Typ	
K	3.18 Typ	

3D View

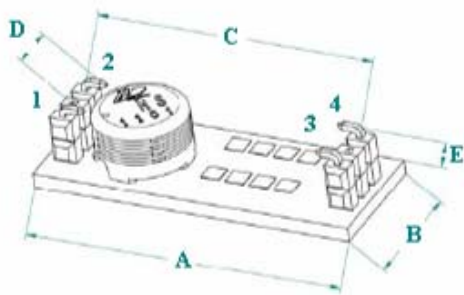

Footprint (Top View)

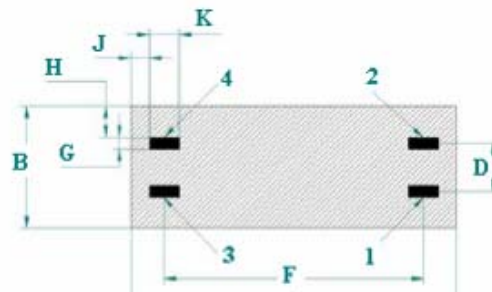

HTM1735LF SR PACKAGE OUTLINE

Package Outline

Dim	Min (mm)	Max (mm)
A	34	36
B	12.5	13.5
C	30.25 Typ	
D	5.08 Typ	
E	6.65 Typ	

3D View

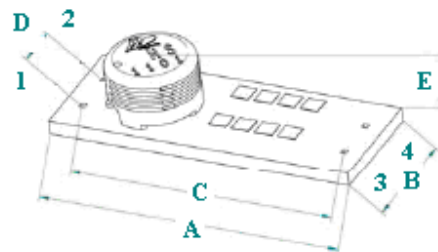

HTM1735LF – Temperature and Relative Humidity Module

ORDERING INFORMATION

HPP805D033: HTM1735LF STD (THROUGH HOLE BOARD-TO-BOARD CONNECTION)

HPP805D034: HTM1735LF SR (WITH HOLES FOR CUSTOMIZED WIRING)

HPP805035: HTM1735LF SMD (SMD BOARD-TO-BOARD CONNECTION)

Customer Service contact details

Measurement Specialties, Inc.
105 av. du Général Eisenhower
BP 23705 31037 TOULOUSE CEDEX 1
FRANCE
Tél: +33 (0) 561 194 848
Fax: +33 (0) 561 194 553
Sales: humidity.sales@meas-spec.com

Revision	Comments	Who	Date
K	Standardized datasheet format	D.LE GALL	May 08

The information in this sheet has been carefully reviewed and is believed to be accurate; however, no responsibility is assumed for inaccuracies. Furthermore, this information does not convey to the purchaser of such devices any license under the patent rights to the manufacturer. Measurement Specialties, Inc. reserves the right to make changes without further notice to any product herein. Measurement Specialties, Inc. makes no warranty, representation or guarantee regarding the suitability of its product for any particular purpose, nor does Measurement Specialties, Inc. assume any liability arising out of the application or use of any product or circuit and specifically disclaims any and all liability, including without limitation consequential or incidental damages. Typical parameters can and do vary in different applications. All operating parameters must be validated for each customer application by customer's technical experts. Measurement Specialties, Inc. does not convey any license under its patent rights nor the rights of others.

Mouser Electronics

Authorized Distributor

Click to View Pricing, Inventory, Delivery & Lifecycle Information:

[TE Connectivity:](#)

[HTM1735LF](#) [HPP805D033](#)