

M85049/128-3 ✓ ACTIVE

Raychem | Raychem AS85049

TE Internal #: CW2823-000

Raychem AS85049, Screened Backshells & Adapters, 303 Stainless Steel, Cable-to-Cable, None / M85049, Sealable

[View on TE.com >](#)



Connectors > Connector Backshells & Adapters > Screened Backshells & Adapters



Backshell Material: **303 Stainless Steel**

Connector System: **Cable-to-Cable**

Termination Device Type: **M85049, None**

Sealable: **Yes**

Features

Product Type Features

Connector System	Cable-to-Cable
Termination Device Type	M85049, None
Sealable	Yes

Body Features

Backshell Material	303 Stainless Steel
--------------------	---------------------

Industry Standards

Connector Detail Specification Number	M85049/128-3
---------------------------------------	--------------

Product Compliance

[For compliance documentation, visit the product page on TE.com>](#)

EU RoHS Directive 2011/65/EU	Compliant
EU ELV Directive 2000/53/EC	Compliant
China RoHS 2 Directive MIIT Order No 32, 2016	No Restricted Materials Above Threshold
EU REACH Regulation (EC) No. 1907/2006	Current ECHA Candidate List: JAN 2021 (211) Candidate List Declared Against: JAN 2021 (211) Does not contain REACH SVHC
Halogen Content	Low Halogen - Br, Cl, F, I < 900 ppm per homogenous material. Also BFR/CFR/PVC Free
Solder Process Capability	Not applicable for solder process capability

Product Compliance Disclaimer

This information is provided based on reasonable inquiry of our suppliers and represents our current actual knowledge based on the information they provided. This information is subject to change. The part numbers that TE has identified as EU RoHS compliant have a maximum concentration of 0.1% by weight in homogenous materials for lead, hexavalent chromium, mercury, PBB, PBDE, DBP, BBP, DEHP, DIBP, and 0.01% for cadmium, or qualify for an exemption to these limits as defined in the Annexes of Directive 2011/65/EU (RoHS2). Finished electrical and electronic equipment products will be CE marked as required by Directive 2011/65/EU. Components may not be CE marked. Additionally, the part numbers that TE has identified as EU ELV compliant have a maximum concentration of 0.1% by weight in homogenous materials for lead, hexavalent chromium, and mercury, and 0.01% for cadmium, or qualify for an exemption to these limits as defined in the Annexes of Directive 2000/53/EC (ELV). Regarding the REACH Regulation, the information TE provides on SVHC in articles for this part number is based on the latest European Chemicals Agency (ECHA) 'Guidance on requirements for substances in articles' posted at this URL: <https://echa.europa.eu/guidance-documents/guidance-on-reach>

Compatible Parts



TE Part # CAT-R85049-1I
M85049/82 Unscreened, Banding Backshells



TE Part # CAT-R85049-1G
M85049/82 Unscreened, Banding Backshells



TE Part # CAT-R85049-1H
M85049/84 Unscreened, Banding Backshells



TE Part # CAT-R85049-1A
M85049/82 Screened, Banding Backshells



TE Part # CAT-R85049-1D
M85049/83 Unscreened, Banding Backshells



TE Part # CAT-R85049-1E
M85049/83 Unscreened, Banding Backshells



TE Part # CAT-R85049-1C
M85049/83 Screened, Banding Backshells



TE Part # CAT-R85049-1F
M85049/84 Unscreened, Banding Backshells



TE Part # CAT-R85049-1B
M85049/84 Screened, Banding Backshells



TE Part # CJ2087-000
HL2010E-KIT-120V



TE Part # AAF1139-00
BTH3-09-03-1-C-SE



TE Part # AAF2404-00
BTH3-09-04-1-B-SE



TE Part # AAF1140-00
BTH3-09-04-1-C-SE



TE Part # AAF1141-00
BTH3-11-05-1-C-SE



TE Part # AAF1142-00
BTH3-11-06-1-C-SE



TE Part # AAF1143-00
BTH3-13-07-1-C-SE



TE Part # AAF1144-00
BTH3-13-08-1-C-SE



TE Part # AAF1145-00
BTH3-15-09-1-C-SE



TE Part # AAF4208-00
BTH3-15-10-1-B-SE



TE Part # AAF1146-00
BTH3-15-10-1-C-SE

Also in the Series | **Raychem AS85049**



Backshell Accessories(1)



Screened Backshells & Adapters(137)



Unscreened Backshells & Adapters (267)

Customers Also Bought



TE Part #205560-2
AMPLIMITE,ASY,PLUG,STD,109,3



TE Part #4-1617758-7
FCB-205-0222M=M83536/2-022M



TE Part #204514-2
RECEIPT ASSY,26 POSN,AMPLIMITE



TE Part #205556-2
AMPLIMITE,ASY,PLUG,STD,109,1

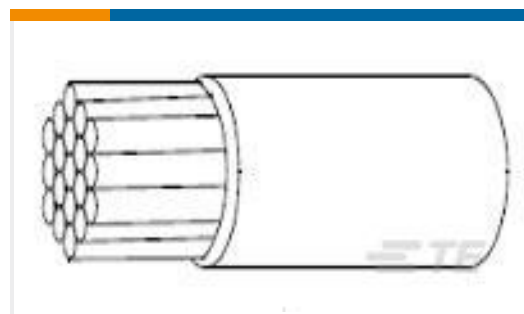

TE Part #216367-001
22759/33-22-9



TE Part #38941-12L
CONT PIN



TE Part #6032624002
NTFR-2-0-SP



TE Part #38941-16
CONTACTS



TE Part #38943-12L
CONTACT T12 FEMELLE (= 724-0007-12)

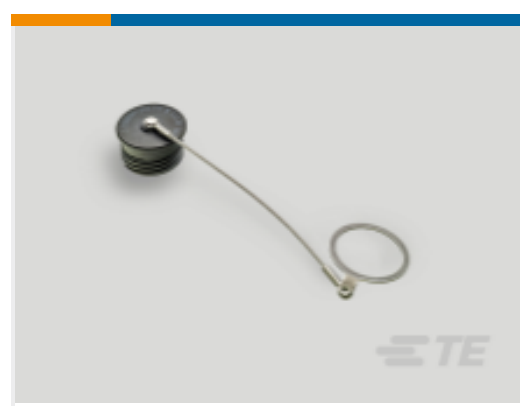

TE Part #YDTS32F13NV0010000
DUST COVER ASSEM

Documents

Product Drawings

[R85049/128-3](#)

English

Datasheets & Catalog Pages

[AS85049 Adapters and Band Straps](#)

English

Instruction Sheets

[Instruction Sheet \(U.S.\)](#)

English

Mouser Electronics

Authorized Distributor

Click to View Pricing, Inventory, Delivery & Lifecycle Information:

[TE Connectivity:](#)

[R85049/128-3](#) [M85049/128-3](#) [CW2823-000](#)