

**T92 Series Two-pole Power Relay**

- 30/40/50A switching capability
- Designed to control compressor loads to 3.5 tons, 110LRA / 25.3FLA
- Meets requirements of UL 508 and UL 873 spacings - 8mm through air, 9.5mm over surface
- Meets requirements of VDE 8mm spacing, 4kV dielectric coil-to-contact
- Meets requirements of UL Class F construction
- UL approved for 600VAC switching (1.5HP)
- Screw terminal version (consult factory for availability, ratings)
- Anti-explosive version available (Meets EN 60079-15)
- WG version available (Meets EN 60335-1)

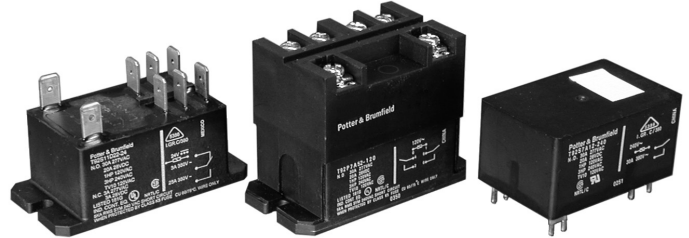

Typical applications

HVAC, residential / commercial appliances, industrial controls, charging

**Approvals**

UL E22575; CSA LR48471; VDE 40019600; TUV R 50083843 0008; TUV 15090924 002; TUV 15090883 001

Technical data of approved types on request.

**Contact Data**

Type	T92	T92H
Contact arrangement	2 form A (NO) 2 form C (CO)	2 form A (NO)
Rated voltage	277VAC	
Max. switching voltage	600VAC	
Rated current	30A/40A NO; 3A NC	50A NO
Overload current*	60A NO; 4.5A NC	75A NO
Contact material	Ag Alloy	
Min. recommended contact load	500mA (NO), 12VAC or 5VDC 100mA (NC), 12VAC or 5VDC	
Frequency of operation, with load	360 cycles per hour	
Operate/release time max., including bounce	25/25ms	
Initial contact resistance	< 100 mΩ at 6VDC 1A	

\*Note: Minimum electrical endurance 50 cycles

**Contact ratings<sup>1)</sup> (T92H Type)**

UL508	Load	Cycles
NO	50A, 277VAC, resistive, 85°C	6x10 <sup>3</sup>

Note: Coil voltage 12-48VDC covered in UL approval

**Contact ratings<sup>1)</sup> (T92 Type)**

Type	Load	Cycles
<b>UL508</b>		
AgCdO		
NO	40A, 277VAC, resistive	6x10 <sup>3</sup>
NO	30A, 277VAC, resistive (DC coil only)	250x10 <sup>3</sup>
NO	30A, 277VAC, resistive (AC coil only)	100x10 <sup>3</sup>
NO	10A, 600VAC, resistive	250x10 <sup>3</sup>
NO	1HP, 120VAC	100x10 <sup>3</sup>
NO	3HP, 240VAC	1x10 <sup>3</sup>
NO	1.5HP, 480 or 600VAC	100x10 <sup>3</sup>
NO	110LRA/25.3FLA, 240VAC	100x10 <sup>3</sup>
NO	7.3A, 240VAC, pilot duty	100x10 <sup>3</sup>
NO	20A, 28VDC, resistive	100x10 <sup>3</sup>
NO	TV10, 120VAC	25x10 <sup>3</sup>
NC	3A, 277VAC	100x10 <sup>3</sup>
NC	2A, 480VAC, general purpose	100x10 <sup>3</sup>
NC	1A, 600VAC	100x10 <sup>3</sup>

**Contact ratings<sup>1)</sup> (T92 Type) (continued)**

Type	Load	Cycles
AgSnOInO		
NO	40A, 240VAC, resistive 85°C	50x10 <sup>3</sup>
NO	30A, 277VAC, resistive (DC coil only)	250x10 <sup>3</sup>
NO	30A, 277VAC, resistive (AC coil only)	100x10 <sup>3</sup>
NO	20A, 506VAC, resistive	100x10 <sup>3</sup>
NO	1.5HP, 120VAC, 2 pole making/breaking (Fig.1)	100x10 <sup>3</sup>
NO	3HP, 240VAC, 3 phase (DC coil only)	100x10 <sup>3</sup>
NO	3HP, 480VAC, 3 phase (DC coil only)	100x10 <sup>3</sup>
NO	2HP, 600VAC, 3 phase (DC coil only)	100x10 <sup>3</sup>
Special Ag Alloy X (Cd Free), wash tight		
NO	30A, 250VAC, resistive	100x10 <sup>3</sup>
NO	30A, 400VAC, resistive	100x10 <sup>3</sup>
NO	20A, 480VAC, resistive	100x10 <sup>3</sup>

**VDE**

AgCdO, flange mount relays		
NO	20A, 400VAC	100x10 <sup>3</sup>
NC	3A, 400VAC	30x10 <sup>3</sup>
CO	20A NO / 3A NC, 400VAC	30x10 <sup>3</sup>
AgCdO, PC mount relays		
NO	30A, 400VAC	100x10 <sup>3</sup>
NC	3A, 400VAC	30x10 <sup>3</sup>
CO	30A NO / 3A NC, 400VAC	30x10 <sup>3</sup>

Anti-explosion, sealed type

NO	30A 250VAC, 25°C	100x10 <sup>3</sup>
Anti-explosion, break device		
NO	15A 480VAC	100x10 <sup>3</sup>

ARI 780-86 Endurance Test (section 6.6):

HVAC Definite Purpose Contactor Standard

Normally Open Contacts

Single Phase/Two Pole (Both poles together switching a single load)  
110 LRA, 25.3 FLA, 200K operations (DC Coil)

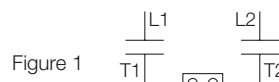

Figure 1

Single Phase Per Pole (Single load per pole)

110 LRA, 18 FLA, 200K operations (DC Coil).  
60 LRA, 14 FLA, 200K operations (AC Coil).

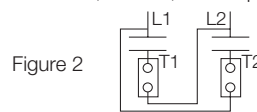

Figure 2

1) Contact ratings at 25°C (unless otherwise noted) with relay properly vented. FLA, LRA ratings are compatible with 3.5 ton compressor applications.

Mechanical endurance

T92	10x10 <sup>6</sup> ops.
T92H	1x10 <sup>6</sup> ops.

**T92 Series Two-pole Power Relay (Continued)**

**Coil Data**

Coil voltage range	5 to 110VDC; 12 to 240VAC
Max. coil power	1.7W; 4.0VA
Max. coil temperature	155°C
Coil insulation system according UL	Class F

**Coil versions, DC coil (D type)**

Coil code	Rated voltage <sup>2)</sup> VDC	Operate voltage <sup>3)</sup> VDC	Release voltage VDC	Coil resistance $\Omega \pm 10\%$	Rated coil power W
5	5	3.75	0.6	14.9	
6	6	4.5	0.6	22	
9	9	6.75	0.9	48	
12	12	9	1.2	86	
18	18	13.5	1.8	197	1.7W/
22	22	16.5	2.2	294	Min. 0.41W
24	24	18	2.4	350	hold
36	36	27	3.6	767	
48	48	36	4.8	1390	
110	110	82.5	11	7255	
120	120	90	12	8514	

2) For T92H type, after the energization time of 100ms with rated voltage, the coil requires a reduction of the coil voltage to 50% of rated voltage.

3) For Anti-explosion sealed type, the operate voltage is 80% of the rated coil voltage.

**Coil versions, AC coil (A type)**

Coil code	Rated voltage VAC	Frequency Hz	Operate voltage VAC, 60Hz	Release voltage VAC, 60Hz	Coil resistance $\Omega \pm 10\%$	Rated coil power VA
12	12	60	9.6	1.2	9.1	4
24	24	60	19.2	2.4	36.6	4
110	110	60	88	11	793	4
120	110/120	50/60	96	12	950	4
208	208	60	166.4	20.8	2841	4
240	220/240	50/60	192	24	3800	4
277	250/277	50/60	221.6	27.7	5485	4

**Coil versions, AC coil (F type)**

Coil code	Rated voltage VAC	Frequency Hz	Operate voltage VAC, 60Hz	Release voltage VAC, 60Hz	Coil resistance $\Omega \pm 10\%$	Rated coil power VA
12	12	50	9.6	1.2	11.2	3.5
24	24	50	19.2	2.4	44.4	3.5
48	48	50	38.4	4.8	179.2	3.5
240	240	50	192	24	4355	3.5

All figures are given for coil without preenergization, at ambient temperature +23°C. For A type, 110V/120V, 50/60Hz. Signify 50Hz Operation at Nominal 110V, 60 Hz Operation at Nominal 120V.

**Coil Data (continued)**

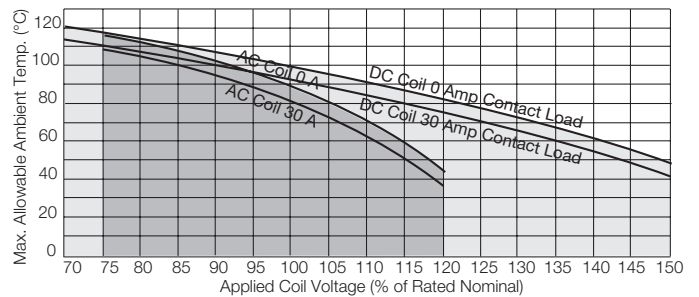

Note: This chart only apply for T92 standard type. For coil data of T92 Anti-explosion sealed type and T92H type, please contact TE engineering.

**Insulation Data**

Initial dielectric strength	1500V <sub>rms</sub>
between open contacts	4000V <sub>rms</sub>
between contact and coil	2000V <sub>rms</sub>
between adjacent contact	
Initial surge withstand voltage	8kV
between contact and coil	
Initial insulation resistance (@500VDC)	1x10 <sup>9</sup> Ω
between insulated elements	
Clearance/creepage	8mm clearance/9.5mm creepage
between contact and coil	

**Other Data**

Material compliance:	EU RoHS/ELV, China RoHS, REACH, Halogen content refer to the Product Compliance Support Center at <a href="http://www.te.com/customer-support/rohssupportcenter">www.te.com/customer-support/rohssupportcenter</a>
Ambient temperature	
DC coil	-55°C to 85°C
AC coil	-55°C to 65°C
Category of environmental protection	RTI - dust protected, RTII - flux proof, RTIII - wash tight
IEC 61810	
Vibration resistance (functional)	1.65mm max amplitude, 10-55 Hz
Shock resistance (functional)	10G for 11msec
Shock resistance (destructive)	100G
Terminal type	PCB / Quick Connect / Screw

**T92 Series Two-pole Power Relay (Continued)**

**Dimensions**

T92/T92H – Mounting and termination code 1

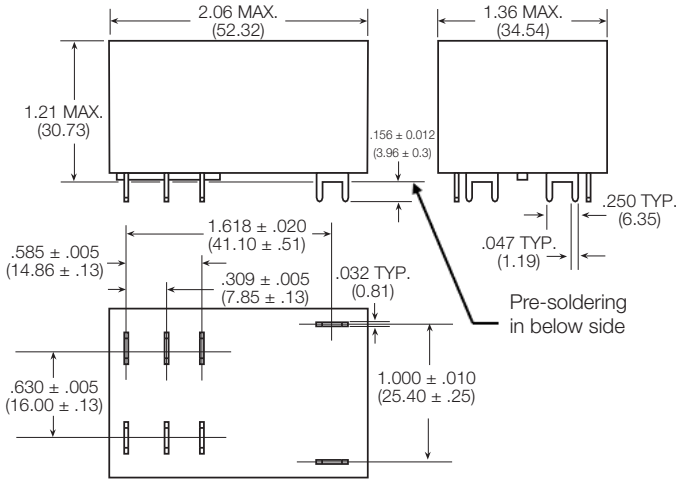

Note: Dimensions of the pins after tin soldering  
a) +0.3mm for the width and the thickness  
b) +1.0mm for the length

T92 – Mounting and termination code 2, 3 and 4

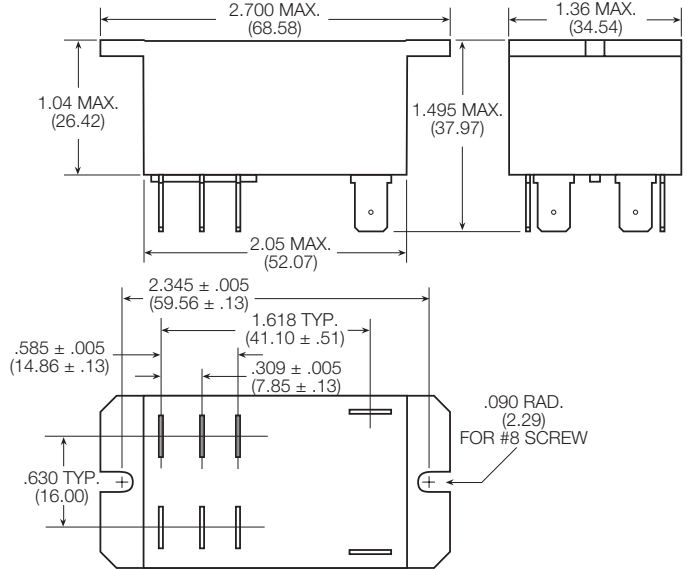

T92 – Mounting and termination code 5

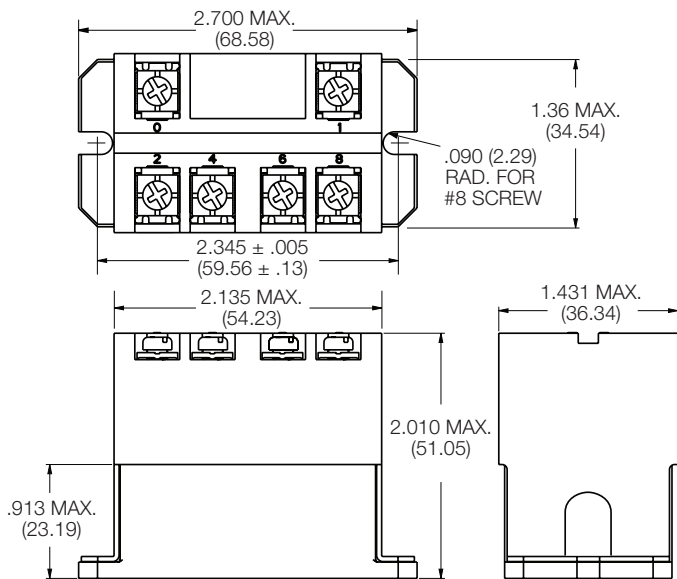

**PCB layout**

Bottom view on pins

T92/T92H - Mounting and termination code 1

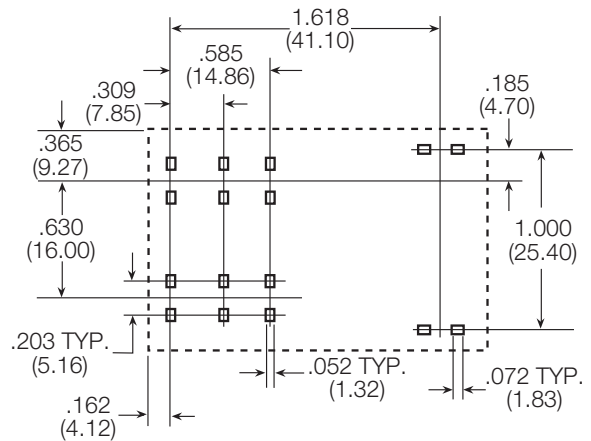

An alternate PC board layout utilizes .076 ± .003 (1.93 ± .076) diameter holes on the same center-to-center spacing shown above. Use of the rectangular holes is recommended for improved solderability.

Only necessary terminals are present on single throw models. Consequently, some holes will be unnecessary for single throw models.

**Terminal assignment**

Bottom view on pins

2 form A

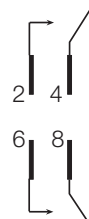

2 form C

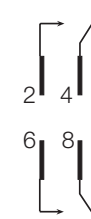

**T92 Series Two-pole Power Relay** (Continued)

<b>Product code structure (T92H type)</b>		Typical product code	<b>T92H</b>	<b>P</b>	<b>7</b>	<b>D</b>	<b>1</b>	<b>X</b>	<b>-12</b>
<b>Type</b>		<b>T92H</b> Power relay T92 High Performance (50A)							
<b>Enclosure</b>		<b>P</b> Dust protected plastic case <b>S</b> Wash-tight, tape sealed, plastic case (Mounting and termination code 1)							
<b>Contact arrangement</b>		<b>7</b> 2 form A (2 NO)							
<b>Coil Input</b>		<b>D</b> DC voltage							
<b>Mounting and termination</b>		<b>1</b> Printed circuit board mount; printed circuit board terminals.							
<b>Contact material</b>		<b>X</b> Special Ag Alloy X (Cd Free)							
<b>Coil voltage</b>		Coil code: please refer to coil versions table							

Product code	Enclosure	Contacts	Coil	Mounting	Contact Material	Coil	Part number
T92HP7D1X-12	Plastic dust cover	2 form A, 2 NO	DC	PCB terminals	Special Ag Alloy X (Cd Free)	12VDC	6-1423008-6
T92HP7D1X-24						24VDC	6-1423008-7
T92HP7D1X-48						48VDC	6-1423008-9

Note. This list represents the most common types and does not show all variants covered by this datasheet, other types on request.

**Product code structure (T92 type)**

<b>Product code structure</b>		Typical product code	<b>T92</b>	<b>S</b>	<b>11</b>	<b>D</b>	<b>2</b>	<b>2</b>	<b>-24</b>	<b>-99</b>
<b>Type</b>		<b>T92</b> Printed circuit board / panel mount power relay T92								
<b>Enclosure</b>		<b>P</b> Dust protected plastic case <b>S</b> Wash-tight, tape sealed, plastic case (Mounting and termination code 1) Wash-tight, glue sealed, plastic case (Mounting and termination code 1, 2 for anti-explosion version) Top sealed, not wash-tight, not tape sealed on bottom (Mounting and termination codes 2, 3 & 4)								
<b>Contact arrangement</b>		<b>7</b> 2 form A (2 NO) <b>11</b> 2 form C (2 CO)								
<b>Coil Input</b>		<b>A</b> AC voltage, 60Hz or 50/60 Hz (consult coil versions table) <b>D</b> DC voltage <b>F</b> AC voltage, 50Hz								
<b>Mounting and termination</b>		<b>1</b> Printed circuit board mount; printed circuit board terminals. <b>2</b> Panel mount via flanged cover; .250" (6.35mm) x .032" (.81mm) QC terminal <b>3</b> Panel mount via flanged cover; .187" (4.75mm) x .032" (.81mm) QC terminals for coil and .250" (6.35mm) for contacts <b>4</b> Panel mount via flanged cover, .187" (4.75mm) x .020" (.51mm) QC terminals for coil and .250" (6.35mm) for contacts. <b>5</b> Panel mount via flanged cover, M4 screws w/ captive pressure plates. Requires Enclosure P and Contact arrangement 7.								
<b>Contact material</b>		<b>2</b> AgCdO <b>4</b> AgSnOInO <b>X</b> Special Ag Alloy X (Cd Free)								
<b>Coil voltage</b>		Coil code: please refer to coil versions table								
<b>Customer code</b>		<b>-99</b> Anti-explosion <b>-00</b> WG version								

**T92 Series Two-pole Power Relay** (Continued)

Product Code	Enclosure	Contacts	Coil	Mounting	Contact Material	Coil	Part Number					
T92P7A22-24	Plastic dust cover	2 form A, 2 NO	AC	Panel mount + quick connect	AgCdO	24 VAC	6-1393211-0					
T92P7A22-120						120 VAC	5-1393211-7					
T92P7A22-240						240 VAC	6-1393211-2					
T92P7A22-277						277 VAC	6-1393211-3					
T92P7A24-240						AgSnOInO	240 VAC	3-1423008-3				
T92P7A52-120							Panel mount + screw terminals	120 VAC	1423008-8			
T92P7A52-240						240 VAC		1-1423008-2				
T92P7D12-12						DC		PCB terminals		12 VDC	6-1393211-5	
T92P7D14-12										AgSnOInO	12 VDC	2-1423008-1
T92P7D12-24										AgCdO	24 VDC	6-1393211-6
T92P7D22-12	Panel mount + quick connect	12VDC	6-1393211-9									
T92P7D22-24		24 VDC	7-1393211-1									
T92P7D22-48	48 VDC	7-1393211-2										
T92P7D24-12	AgSnOInO	12VDC	2-1423008-2									
T92P7D24-24		24 VDC	1423008-9									
T92P7D42-24	AgCdO				12 VDC					7-1393211-5		
T92P7D52-12					24 VDC					1423008-0		
T92P7D52-24	12 VDC	1-1423008-0										
T92P11A12-120		2 form C, 2 CO	AC	PCB terminals		120 VAC	3-1393211-8					
T92P11A22-12						Panel mount + quick connect	12 VAC	3-1393211-9				
T92P11A22-24							24 VAC	4-1393211-3				
T92P11A22-120						120 VAC	4-1393211-0					
T92P11A22-240						240 VAC	4-1393211-4					
T92P11A22-277						277 VAC	4-1393211-6					
T92P11A24-240						AgSnOInO	240 VAC	3-1423008-7				
T92P11A42-120							120VAC	4-1393211-8				
T92P11D12-12						DC		PCB terminals		12 VDC	5-1393211-0	
T92P11D22-12										Panel mount + quick connect	24 VDC	5-1393211-3
T92P11D22-24	24 VDC	5-1393211-4										
T92P11D24-12	AgSnOInO	12 VDC	3-1423008-5									
T92P11D24-24		24 VDC	3-1423008-6									
T92S7A12-24	Wash tight	2 form A, 2 NO	AC	PCB terminals	AgCdO					24 VAC	9-1393211-8	
T92S7A12-120						120 VAC	9-1393211-7					
T92S7A12-240						240 VAC	9-1393211-9					
T92S7A22-24						Top sealed				24 VAC	1393212-4	
T92S7A22-120										120 VAC	1393212-2	
T92S7A22-240						240 VAC	1393212-5					
T92S7D12-12						Wash tight		DC	PCB terminals		12 VDC	1393212-8
T92S7D12-24											24 VDC	1-1393212-0
T92S7D12-48											48 VDC	1-1393212-1
T92S7D12-110											110 VDC	1393212-7
T92S7D14-12	AgSnOInO	12 VDC	1-1423008-6									
T92S7D14-24		24 VDC	1-1423008-8									
T92S7D22-12	Top sealed				AgCdO	12 VDC	1-1393212-4					
T92S7D22-18						18 VDC	1-1393212-5					
T92S7D22-24						24 VDC	1-1393212-7					
T92S7D22-110						110 VDC	1-1393212-3					
T92S11A12-24						Wash tight	2 form C, 2 CO	AC	PCB terminals		24 VAC	8-1393211-1
T92S11A12-120	120 VAC	8-1393211-0										
T92S11A12-240	240 VAC	8-1393211-2										
T92S11A22-12	Top sealed										12 VAC	8-1393211-3
T92S11A22-24											24 VAC	8-1393211-6
T92S11A22-120	120 VAC	8-1393211-4										
T92S11A22-240	240 VAC	8-1393211-7										
T92S11D12-12	Wash tight		DC	PCB terminals							12 VDC	8-1393211-9
T92S11D12-24											24 VDC	9-1393211-0
T92S11D12-48											48 VDC	9-1393211-1
T92S11D12-110						110 VDC	8-1393211-8					
T92S11D22-12						Top sealed					12 VDC	9-1393211-3
T92S11D22-24											24 VDC	9-1393211-4
T92P7D12-12-99	Plastic dust cover	2 form A, 2 NO	DC	PCB terminals	AgCdO	12VDC	2-2071223-3					
T92S7D1X-12-99						Wash tight				Special Ag Alloy	12VDC	6-1423008-1
T92S7D2X-12-99	Panel mount + quick connect				X (Cd Free)						12VDC	6-1423008-2
T92S7A22-240-00						Top Sealed(WG)	AC			AgCdO	240VAC	2-2071223-4
T92S7D12-12-00	Wash tight (WG)		DC	PCB terminals		12VDC	1-2071223-7					

Note. This list represents the most common types and does not show all variants covered by this datasheet, other types on request.

# Mouser Electronics

Authorized Distributor

Click to View Pricing, Inventory, Delivery & Lifecycle Information:

[TE Connectivity:](#)

[T92S11A22-24](#)