

REVISIONS				
P	LTR	DESCRIPTION	DATE	APVD
	A	INITIAL RELEASE	07JAN2019	RS HD

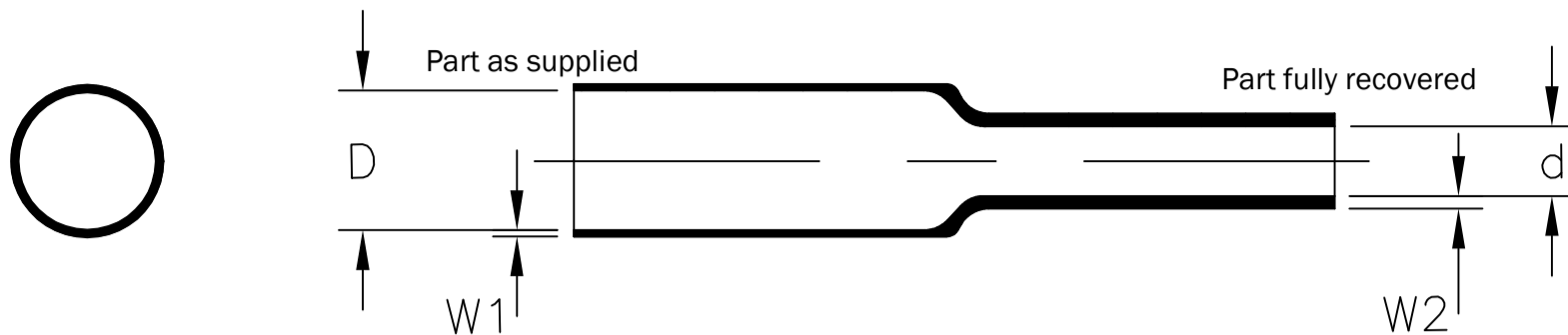

**TUBING DIMENSIONS METRIC**

Size	As Supplied (mm)		As Recovered (mm)	
	Inside Diameter	Wall Thickness	Inside Diameter	Wall Thickness
	<b>D</b>	<b>W1</b>	<b>d</b>	<b>W2</b>
1.0	1.5 ± 0.2	0.2	0.5	0.44
1.5	2.1 ± 0.2	0.2	0.75	0.44
2.0	2.6 ± 0.2	0.25	1.0	0.44
2.5	3.1 ± 0.2	0.25	1.25	0.44
3.0	3.6 ± 0.2	0.25	1.5	0.44
3.5	4.1 ± 0.3	0.25	1.75	0.46
4.0	4.6 ± 0.3	0.25	2.0	0.46
5.0	5.6 ± 0.3	0.3	2.5	0.56
6.0	6.6 ± 0.3	0.3	3.0	0.56
7.0	7.6 ± 0.3	0.3	3.5	0.56
8.0	8.6 ± 0.3	0.3	4.0	0.56
9.0	9.6 ± 0.3	0.3	4.5	0.56
10.0	10.4 ± 0.3	0.3	5.0	0.56
11.0	11.4 ± 0.3	0.3	5.5	0.56
12.0	12.7 ± 0.3	0.3	6.0	0.56
16.0	16.9 ± 0.4	0.35	8.0	0.69
18.0	19.0 ± 0.4	0.4	9.0	0.77
20.0	21.5 ± 0.5	0.4	10.0	0.77
25.0	27.0 ± 0.6	0.45	12.5	0.77
30.0	32.4 ± 0.8	0.45	15.0	0.89

**MATERIAL:** SWFR X2 is a 125°C, 600 volt, VW-1 rated, UL recognized and CSA certified tubing meeting the requirements of UL 224. It is fabricated from Zerohal flame-retarded crosslinked modified flexible polyolefin.

**COLOR:** Black

RELEASED FOR PUBLICATION APR , 2016.

ALL RIGHTS RESERVED.

THIS DRAWING IS UNPUBLISHED.

© COPYRIGHT 2016 TE Connectivity

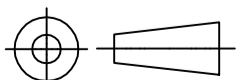
DIMENSIONS: mm	DWN RS	07JAN2019	MATERIAL	-	FINISH	-
	CHK HD	07JAN2019	 TE Connectivity			
TOLERANCES UNLESS OTHERWISE SPECIFIED:	APVD HD	07JAN2019				
0 PLC ± -	PRODUCT SPEC		NAME SWFR X2 BLACK SINGLE WALL HEAT SHRINKABLE TUBING			
1 PLC ± -	APPLICATION SPEC		SIZE	CAGE CODE	DRAWING NO	RESTRICTED TO
2 PLC ± -	WEIGHT		A4		© SWFR_X2_BLACK	-
3 PLC ± -	CUSTOMER DRAWING		SCALE	NTS	SHEET	1 OF 1
4 PLC ± -						REV A
ANGLES ± -						

# Mouser Electronics

Authorized Distributor

Click to View Pricing, Inventory, Delivery & Lifecycle Information:

[TE Connectivity:](#)

[X2-1.5-0-SP-SM](#)