

a) Part as supplied.

202K232-100

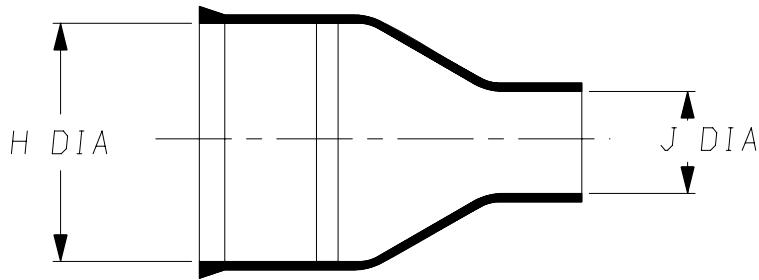

b) Part after unrestricted recovery.

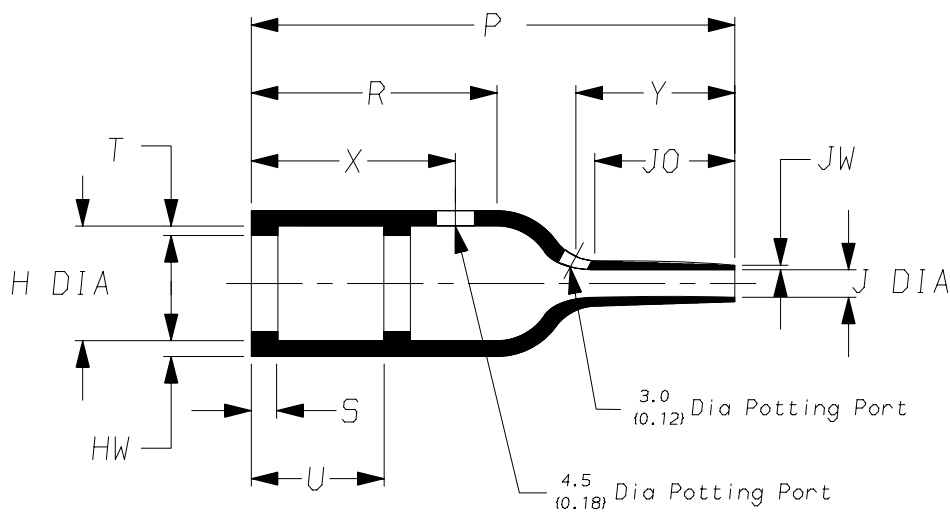

DIMENSIONS in millimetres
(in inches, for reference)

Part No.	H		J		P	R	S	T	U	J0	HW	JW	X	Y
	Min a	Max b	Min a	Max b	±10% b	±10% b	±10% b	±10% b	±10% b	±10% b	±20% b	±20% b	±20% b	±20% b
202K232	25 {0.98}	13.8 {0.54}	8.0 {0.31}	3.3 {0.13}	55 {2.17}	28 {1.10}	3.0 {0.12}	1.0 {0.04}	15 {0.59}	16 {0.63}	1.8 {0.07}	0.5 {0.02}	24 {0.94}	18 {0.71}

Copyright (!)

The copyright in this drawing is the property of Tyco Electronics UK Ltd. The drawing is issued on the condition that it is not copied, reproduced or disclosed to a third party, either in whole or in part without the prior written consent of Tyco Electronics UK Ltd.

Drawn A.LILLEY. Checked Issue 1 Date April 2008

Conforms to ISO Recommendations
3rd Angle Projection
Not to Scale

Approval Design MKTG. Tech.

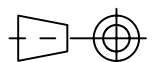

Raychem		Specification Control Drawing	Part Number 202K232-100 Issue 1
Iss.	Date	E.C.R. No.	Details of Change

(Ordering Information)

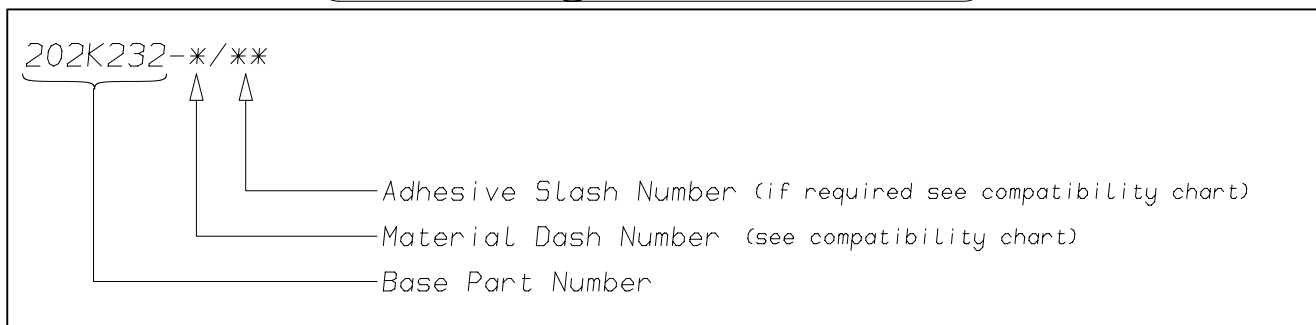

(COMPATIBILITY CHART)

Material Dash Number	Material Description	SPEC Number	Coating Slash Number
-100	ZEROHAL	RW-2058	/86, /180 (see note 3)

NOTES

- ① As supplied dimensions are for uncoated parts, when coating is added entry diameters will reduce by 1.5mm Max.
- ② Potting Ports are optional, when specified by suffix "-00" they will be located as shown.
- ③ ZEROHAL is a trademark of Tyco Electronics

Tyco Electronics UK Ltd. Faraday Road, Swindon, Wiltshire, SN3 5HH England Telephone: (01793) 528171 Fax: 572516	Tyco Electronics Corporation 300, Constitution Drive, Menlo Park, CA 94025 USA Telephone (650) 361-3860 Fax: (650) 361-5579
Cage Code K1010	Cage Code 06090

Mouser Electronics

Authorized Distributor

Click to View Pricing, Inventory, Delivery & Lifecycle Information:

[TE Connectivity:](#)

[202K232-100/86-0](#)