

THIS DRAWING IS UNPUBLISHED. RELEASED FOR PUBLICATION
 © COPYRIGHT BY - ALL RIGHTS RESERVED.

REVISIONS				
P	LTR	DESCRIPTION	DATE	APVD
E		REV PER ECO 18-009576	6-22-18	CT RL

- 1 MATERIAL: HOUSING: ALUMINUM 6061.
CONTACT: BeCu
- 2 FINISH:
HOUSING: 0.025 MIN ELECTROLESS NICKEL
PER AMS-C-26074, GRADE A, CLASS 4.

CONTACT: 1.27µm MIN Au OVER 1.02µm MIN
NICKEL.
- 3 HOLE FOR POSITIVE RETENTION SCREW.
- 4 DASH NUMBERS INDICATE KEY ORIENTATION
(P/N 2000713-2 SHOWN ON DRAWING)
- 5 GROUND PAD Ø5mm ON BOTH SIDE OF PCB.
- 6 GUIDE MODULE W/O KEYING
- 7 MATERIAL: HOUSING: STAINLESS STEEL 303
CONTACT: BeCu
- 8 FINISH: HOUSING: PASSIVATED.
CONTACT: 1.27µm MIN Au OVER
1.02µm MIN NICKEL.

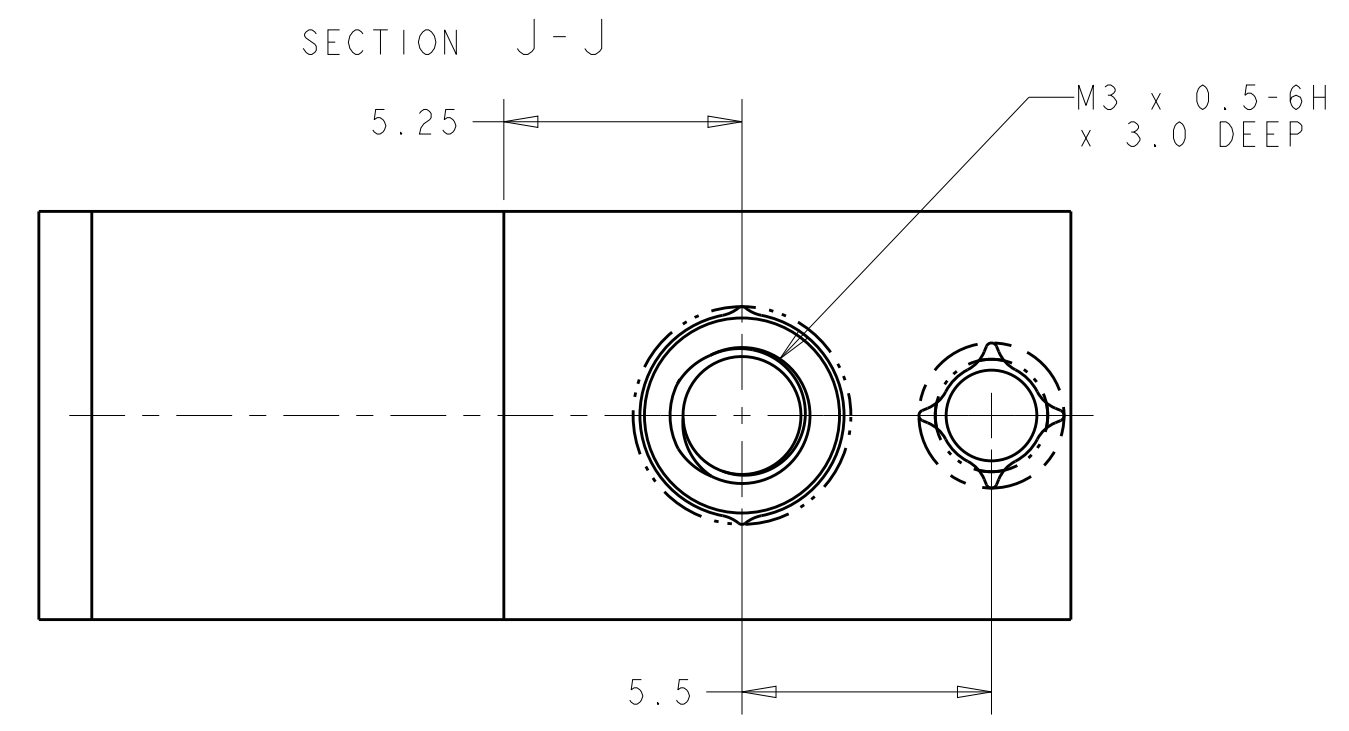
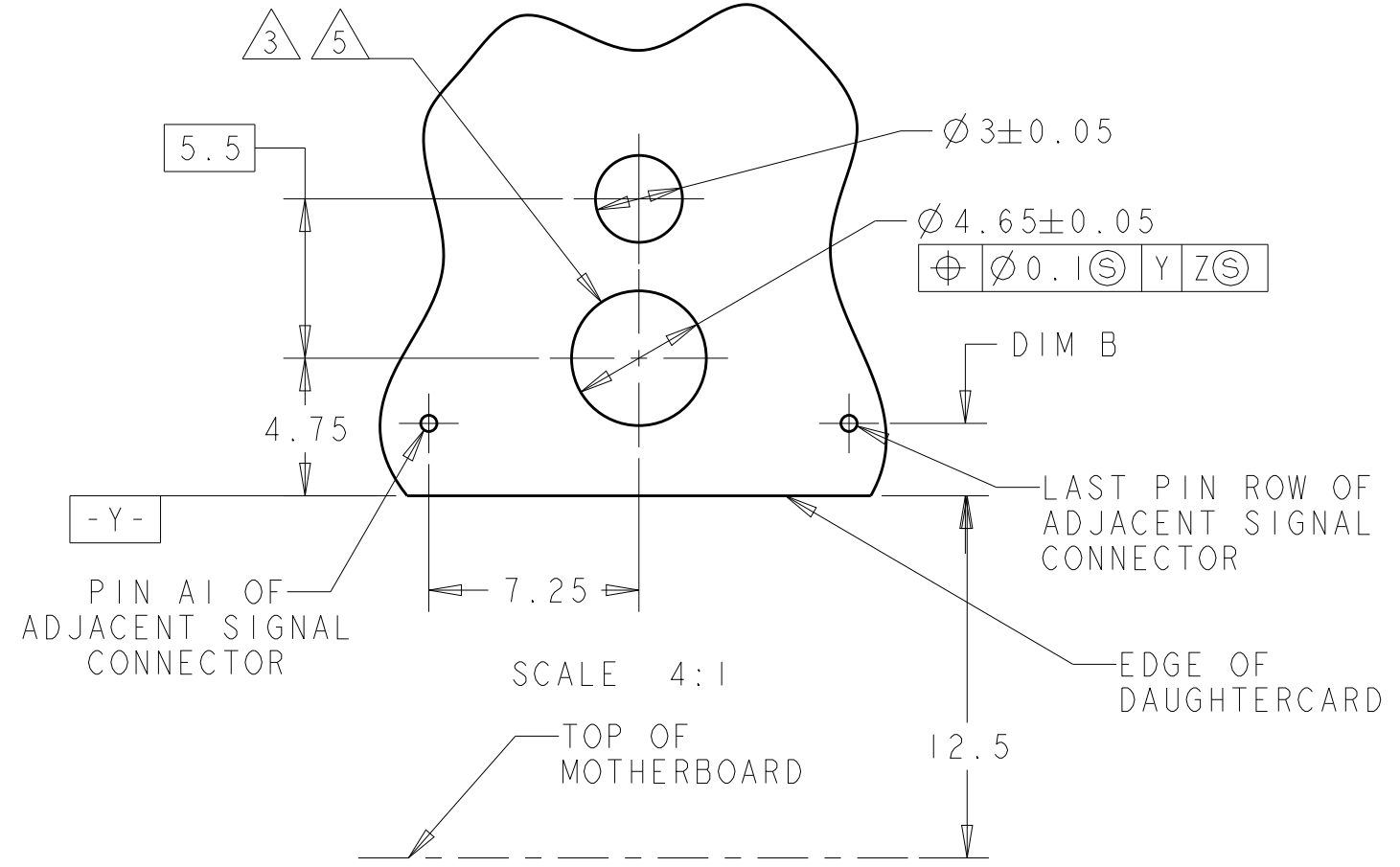
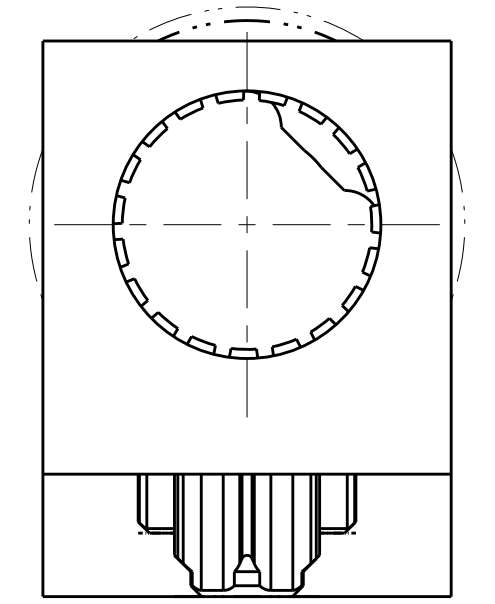
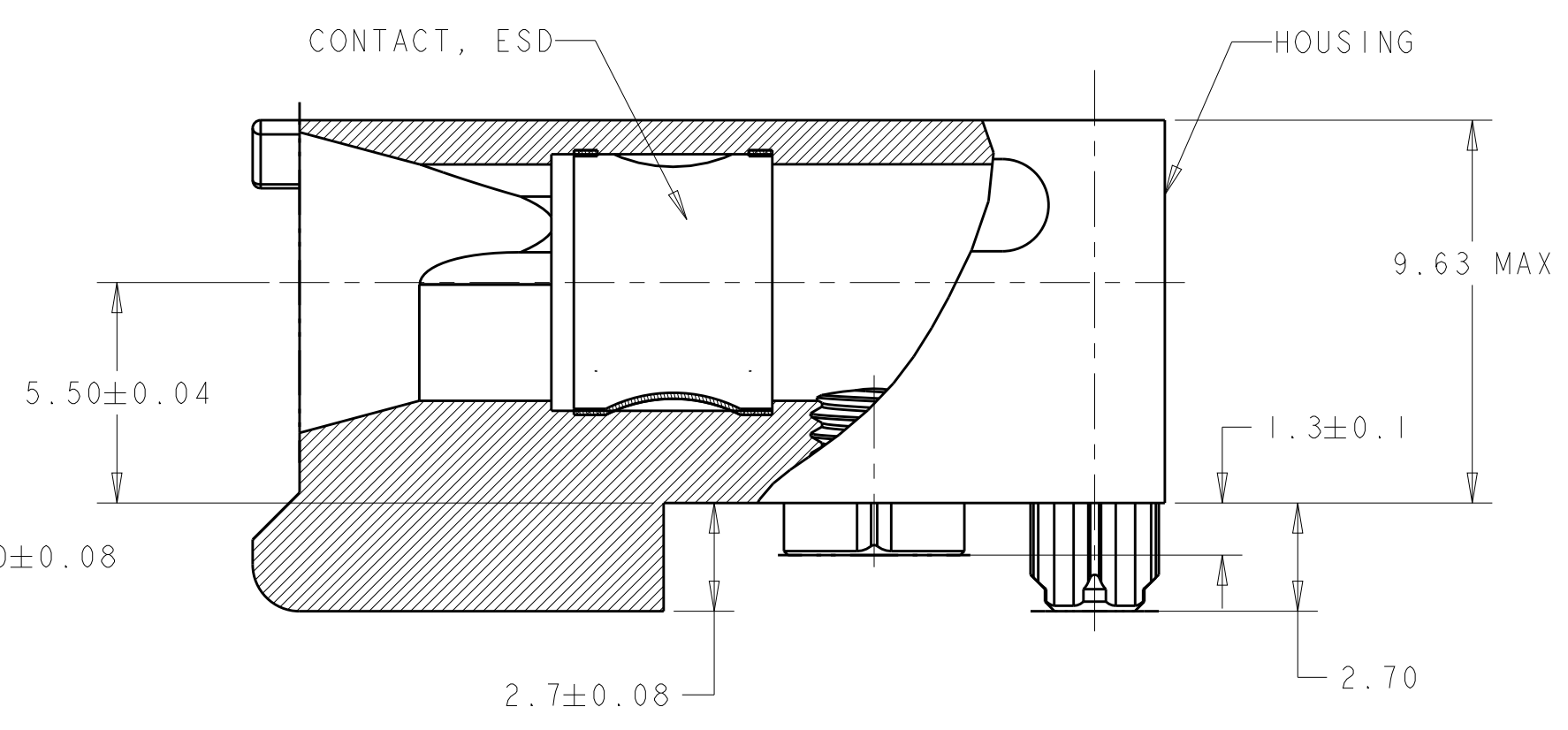
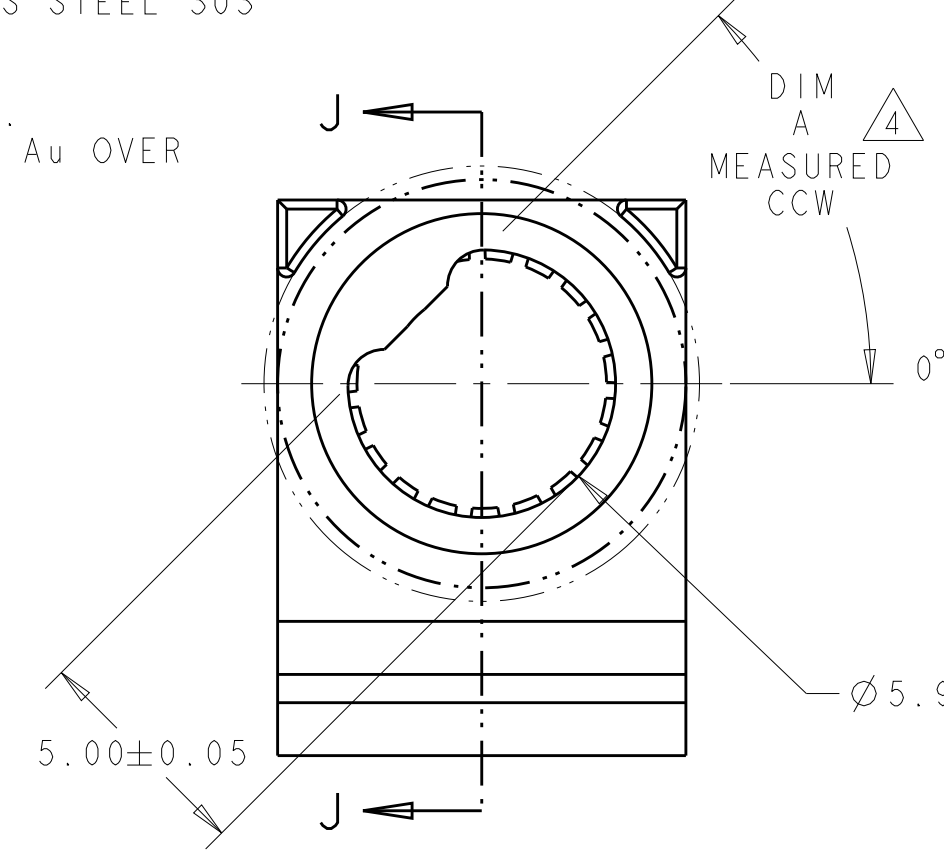
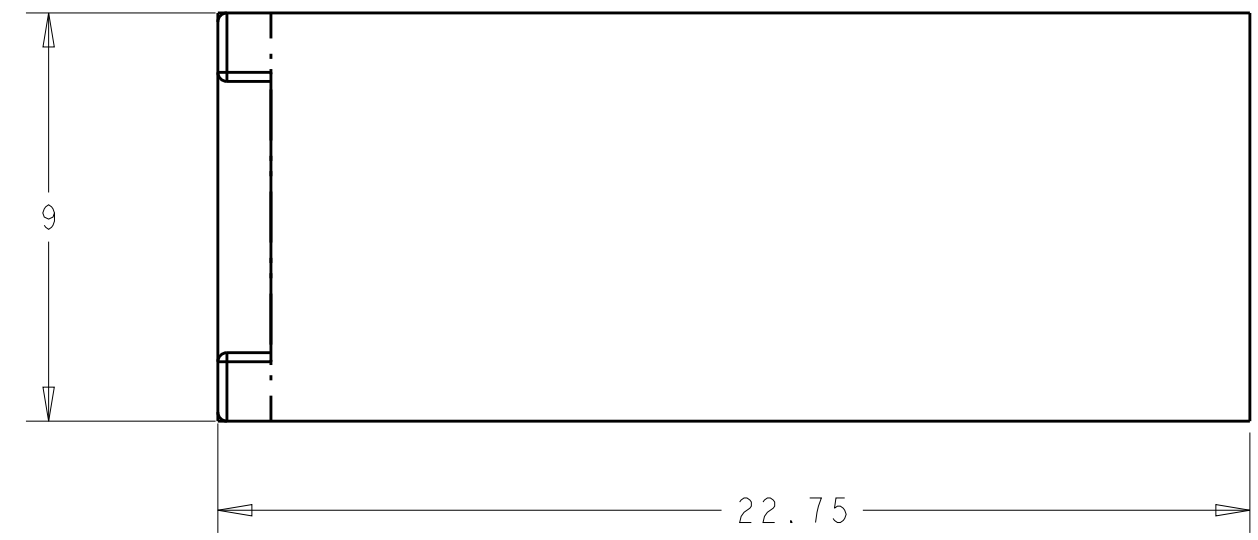

1	2	ANGLE	PART NUMBER
1	2	225°	1-2000713-6
1	2	180°	1-2000713-5
1	2	135°	1-2000713-4
7	8	315°	1-2000713-3
7	8	6	1-2000713-2
7	8	270°	1-2000713-0
7	8	90°	2000713-9
7	8	45°	2000713-8
7	8	0°	2000713-7
1	2	6	2000713-6
1	2	315°	2000713-5
1	2	270°	2000713-4
1	2	90°	2000713-3
1	2	45°	2000713-2
1	2	0°	2000713-1

1.5	TIER 2 (7-ROW)
2.25	TIER 2
2.5	TIER 1
DIM B	PRODUCT

THIS DRAWING IS A CONTROLLED DOCUMENT.

DWN	BH	10 JAN 2008
CHK	MRM	10 JAN 2008
APVD	MRM	10 JAN 2008

STE TE Connectivity

NAME: MULTIGIG GUIDE MODULE/STANDOFF, RIGHT ANGLE, 20.3mm DAUGHTERCARD,

SIZE: A2 CAGE CODE: 00779 DRAWING NO: C-2000713 RESTRICTED TO: E

SCALE: 6:1 SHEET: 1 OF 1 REV: E

Mouser Electronics

Authorized Distributor

Click to View Pricing, Inventory, Delivery & Lifecycle Information:

[TE Connectivity:](#)

[2000713-3](#)