

THIS DRAWING IS A CONTROLLED DOCUMENT

DWG NO. **FDBA_XX_++**

Example of order : **FDBA XX XX XX - XX XX - K XXXX**

CONNECTOR TYPE
Standard and Hermetic

VERSION
5 - Standard
6 - Stainless steel Nickel Plating
7 - Passivated Stainless steel

SHELL TYPE
0 Square Flange Receptacle
4 Jam-nut Mounting Receptacle
6 Plug
7 Plug with RFI (RADIO FREQUENCY INTERFERENCE) fingers

VERSION
Without index - Sealed

SHELL SIZE
08-10-12-14-16-18-20-22-24

ARRANGEMENTS
As per EN3646

CONTACT TYPE
P Male Contact
S Female Contact

INSERT CLOCKING POSITION
N Normal
W-X-Y-Z Others

INDEX
Connector Evolution

SPECIAL MODIFICATIONS
059 Straight Cable Clamp
081 Elbowed Cable Clamp
090 Delivery without contact
A246 Size 20 contact in accordance with ASNE
A499 Nickel version connector
A838 Olive drab cadmium
B246 Hybrid arrangement size 20 & 16 in accordance with ASNE
A377 PC tail connector

For Olive Drab Cadmium plating (A838) - Teeth over the entire periphery

CHARACTERISTIQUES

- Shell material : Aluminium alloy
- Insert material : Thermosetting elastomer
- Plating : Black Anodize, Nickel or Cadmium
- Service Temperature : -55°C to + 200°C
- Service Voltage : Service 1 - 500 V eff. 50 Hz
Service 2 - 750 V eff. 50 Hz

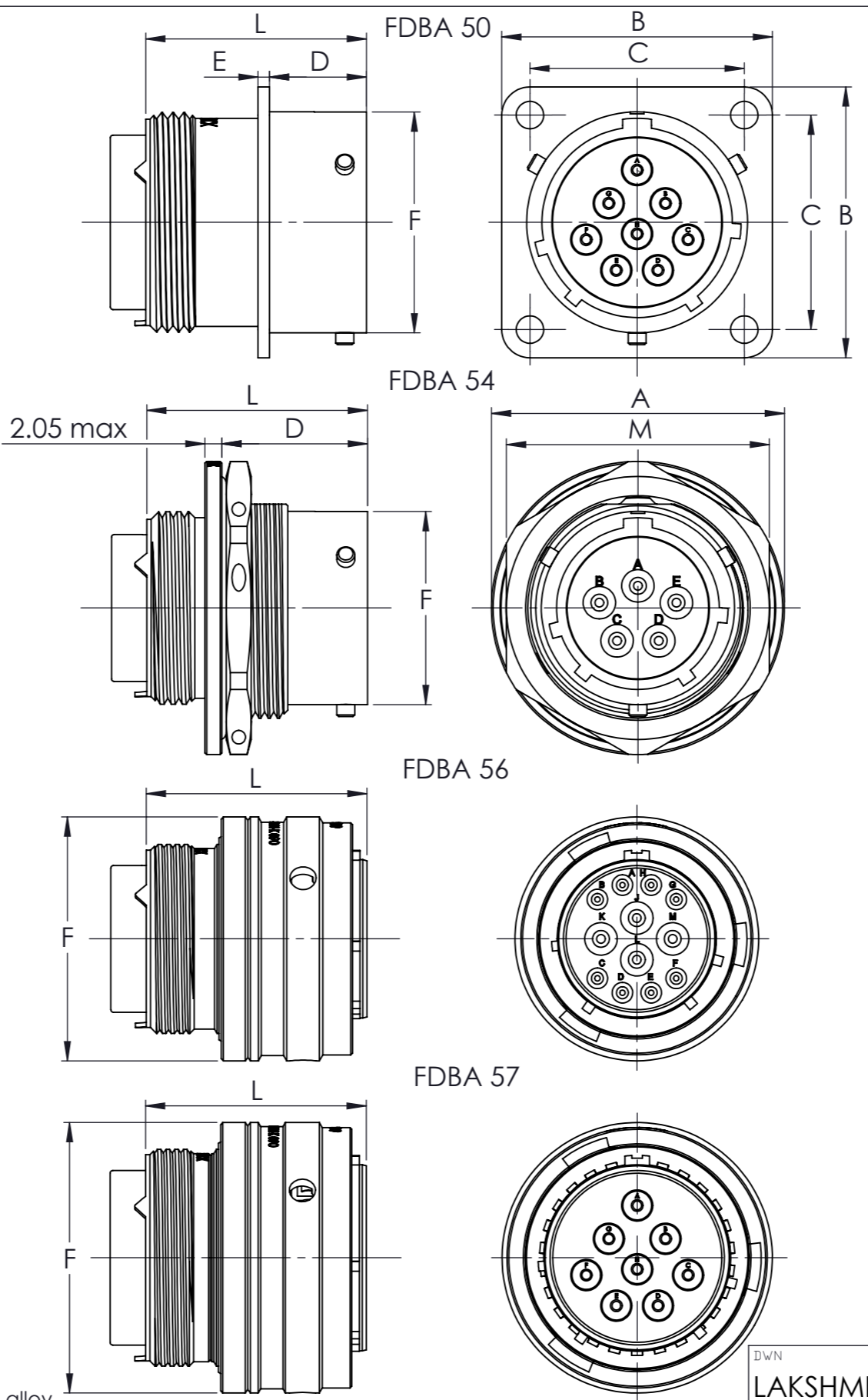
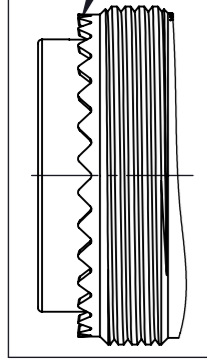

USED DN _

FDBA 50

Size	08	10	12	14	16	18	20	22	24
B max.	21.00	24.25	26.60	29.00	31.30	33.70	36.85	39.95	43.15
C ±0.1	15.08	18.26	20.62	23.02	24.58	26.98	29.36	31.76	34.92
D ±0.15	11.13	11.13	11.13	11.13	11.13	11.13	14.85	14.85	15.70
E max.	1.45	1.45	1.45	1.45	1.45	1.45	2.25	2.25	2.25
F max.	12.03	15.01	19.07	22.24	25.42	28.60	31.77	34.94	38.12
L max.	25.50	25.50	25.50	25.50	25.50	25.50	27.95	27.95	27.95

FDBA 54

Size	08	10	12	14	16	18	20	22	24
A max.	23.30	26.60	30.40	33.80	37.00	40.15	45.20	48.35	51.55
D ±0.1	11.13	11.13	11.13	11.13	11.13	11.13	14.85	14.85	15.70
F max.	12.03	15.01	19.07	22.24	25.42	28.60	31.77	34.94	38.12
L max.	25.50	25.50	25.50	25.50	25.50	25.50	27.95	27.95	27.95
M max.	19.20	22.37	27.12	30.30	33.47	36.67	39.82	43.02	46.17

FDBA 56 & 57

Size	08	10	12	14	16	18	20	22	24
F max.	17.75	21.05	24.60	28.05	31.10	34.40	37.65	40.90	44.10
L max.	25.55	25.55	25.55	25.55	25.55	25.55	27.10	27.10	27.10

Shell type 57 with RFI fingers must be ordered in accordance with part numbering system with the modification A499 (Nickel version connector)

DIMENSIONS: MM		TOLERANCES UNLESS OTHERWISE SPECIFIED:	
0 PLC	±	1 PLC	±0.05
2 PLC	±0.05	3 PLC	±0.02
4 PLC	±		

ANGLES ±°

SURFACE TEXTURE

DWN	LAKSHMI SUDHA R		MATERIAL	-	HEAT TREAT	-			
CHK	RAKESH S								
APVD	VINCENT P		TE Connectivity						
NAME	FDBA SERIES CONNECTOR								
SCALE	2:1	SIZE	A3	DRAWING NO.	FDBA_XX_++	SHEET	1 OF 1	REV	A

THIS INFORMATION IS CONFIDENTIAL AND PROPRIETARY TO TYCO ELECTRONICS CORPORATION AND ITS WORLDWIDE SUBSIDIARIES AND AFFILIATES (TE). IT MAY NOT BE DISCLOSED TO ANYONE, OTHER THAN TE PERSONNEL, WITHOUT AUTHORIZATION FROM TE (www.TE.com).

Mouser Electronics

Authorized Distributor

Click to View Pricing, Inventory, Delivery & Lifecycle Information:

[TE Connectivity:](#)

[ZPF00000000113781](#)