

THIS DRAWING IS UNPUBLISHED. RELEASED FOR PUBLICATION  
 © COPYRIGHT - By - ALL RIGHTS RESERVED.

LOC		DIST		REVISIONS			
P	LTR	DESCRIPTION	DATE	DWN	APVD		
DF	DO	R1	REVISED PER ECO-11-005139	21MAR11	RK	HMR	

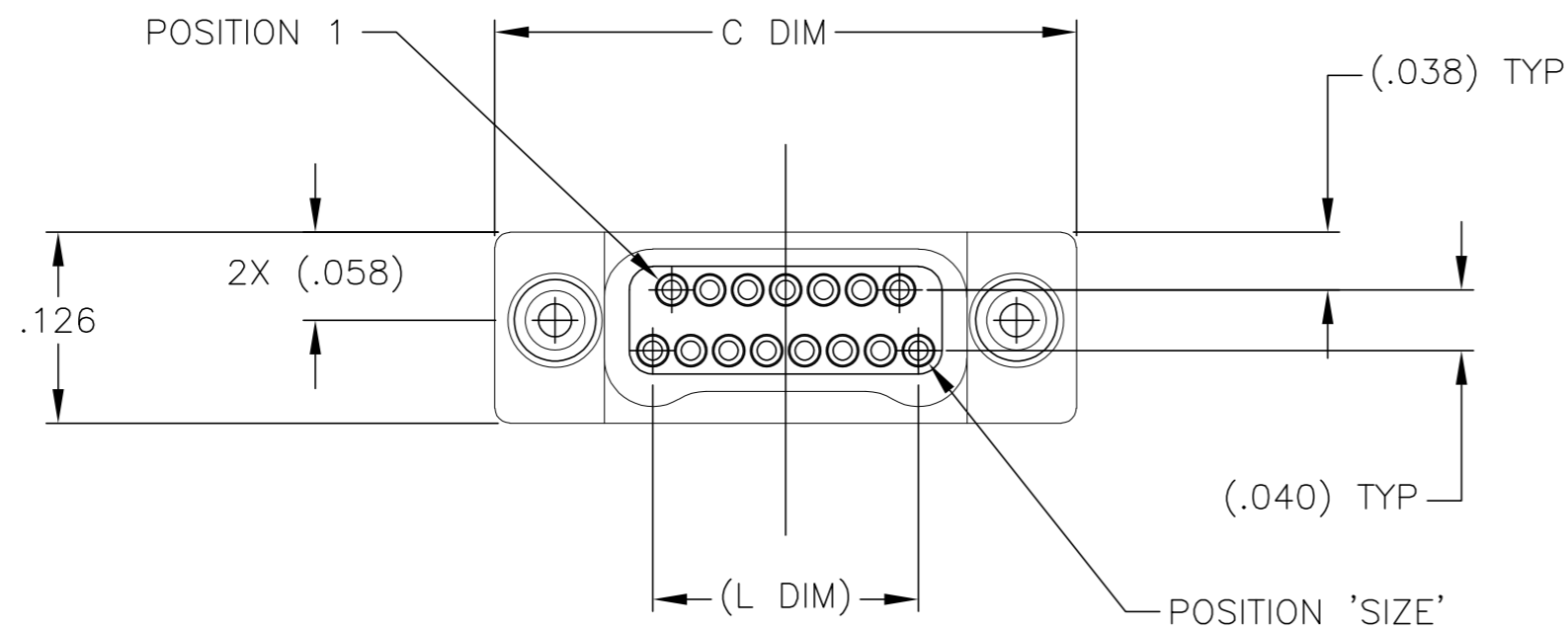
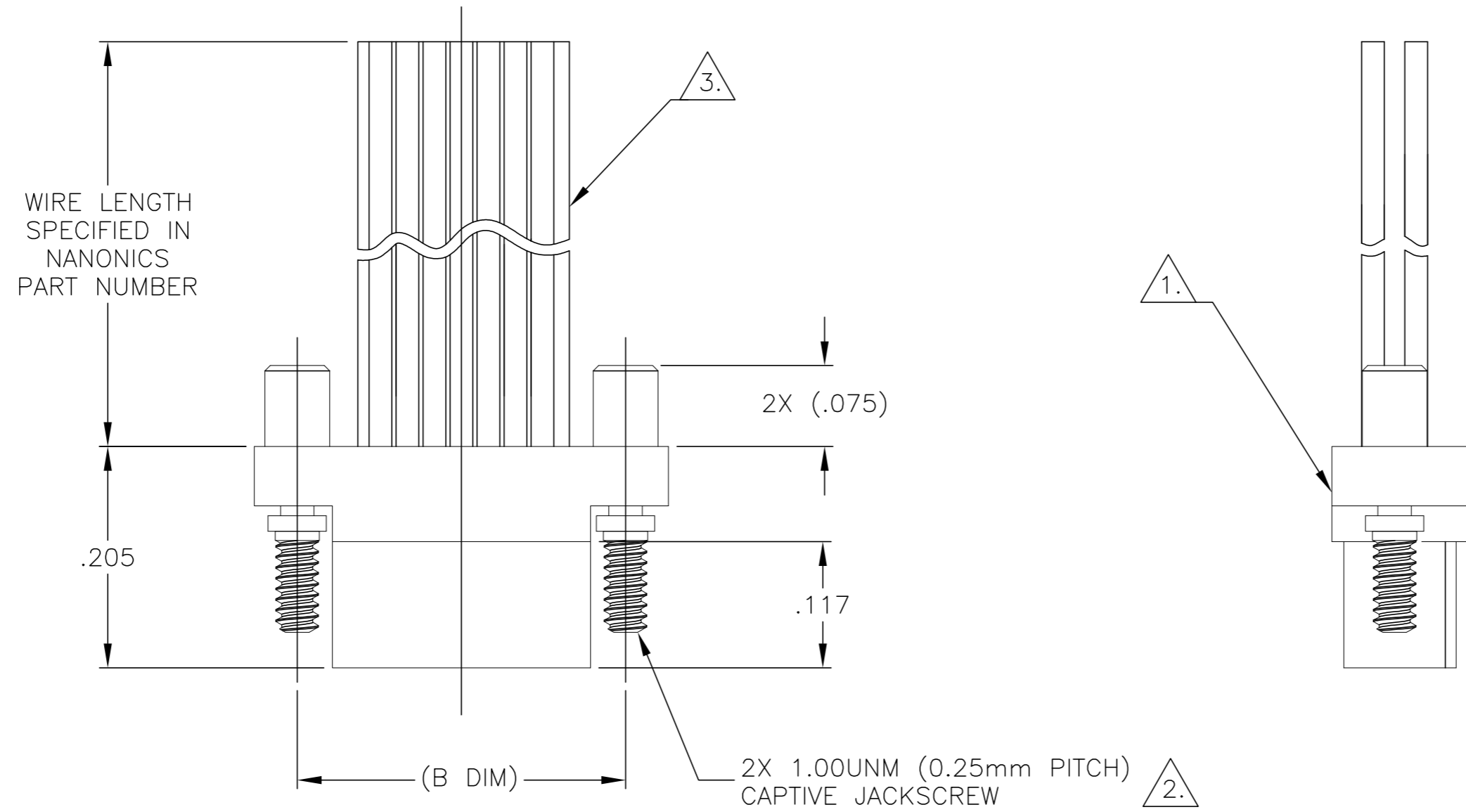

SIZE	(B DIM)	C DIM ±.0050	(L DIM)
09	(.229)	.3085	(.100)
15	(.304)	.3835	(.175)
25	(.429)	.5085	(.300)
37	(.579)	.6585	(.450)
51	(.754)	.8335	(.625)
65	(.929)	1.0085	(.800)

1. SHELL OPTIONS (TO BE SPECIFIED IN NANONICS PART NUMBER):  
 METAL: 6061-T6 ALUMINUM, ELECTROLESS NICKEL PLATED PER MIL-C-26074 (STANDARD) OR GOLD PLATED PER MIL-G-45204  
 303 STAINLESS STEEL, PASSIVATED PER SAE-AMS-QQ-P-35  
 INSULATOR MATERIAL FOR ALL METAL SHELLS IS LIQUID CRYSTAL POLYMER (LCP) PER MIL-M-24519 OR PER ASTM D5138  
 PLASTIC: LIQUID CRYSTAL POLYMER (LCP) PER MIL-M-24519 OR PER ASTM D5138

2. STANDARD 1.00UNM CAPTIVE JACKSCREWS ARE SHOWN FOR REFERENCE ONLY AND MUST BE SPECIFIED IN THE NANONICS PART NUMBER WHEN REQUIRED. JACKSCREW MATERIAL IS 303 STAINLESS STEEL, PASSIVATED PER SAE-AMS-QQ-P-35, AND DRY LUBED PER DOD-L-85645. RETAINING RING IS 17-4 STAINLESS STEEL, PASSIVATED PER SAE-AMS-QQ-P-35. JACKSCREWS HAVE A .9mm HEX SOCKET HEAD. 1.20UNM JACKSCREWS ALSO AVAILABLE.

3. THIS CONFIGURATION MAY BE TERMINATED WITH 28 AWG SOLID, 30 AWG STRANDED OR SMALLER WIRE, OR RIBBON CABLE. CONDUCTOR TYPE AND LENGTH MUST BE SPECIFIED IN NANONICS PART NUMBER.

4. THIS DRAWING PREVIOUSLY IDENTIFIED AS NANONICS N10138/201

THIS DRAWING IS A CONTROLLED DOCUMENT.		DWN D. RYAN 21 APR 92																				
DIMENSIONS: INCHES		CHK E. PAULUS 15 MAY 98																				
TOLERANCES UNLESS OTHERWISE SPECIFIED:		APVD M. STORRY 5 APR 01	NAME PLUG ASSEMBLY, FLYING LEADS, TWO ROW DUALOBE, PLASTIC OR METAL																			
<table border="1"> <tr><td>0 PLC</td><td>±</td><td>-</td></tr> <tr><td>1 PLC</td><td>±</td><td>-</td></tr> <tr><td>2 PLC</td><td>±</td><td>.010</td></tr> <tr><td>3 PLC</td><td>±</td><td>.005</td></tr> <tr><td>4 PLC</td><td>±</td><td>-</td></tr> <tr><td>ANGLES</td><td></td><td>± 1°</td></tr> </table>		0 PLC	±	-	1 PLC	±	-	2 PLC	±	.010	3 PLC	±	.005	4 PLC	±	-	ANGLES		± 1°	PRODUCT SPEC -	SIZE A2	CAGE CODE 00779
0 PLC	±	-																				
1 PLC	±	-																				
2 PLC	±	.010																				
3 PLC	±	.005																				
4 PLC	±	-																				
ANGLES		± 1°																				
MATERIAL SEE NOTES		FINISH SEE NOTES	WEIGHT -	DRAWING NO C=1589472																		
CUSTOMER DRAWING		SCALE 8:1	SHEET 1 of 1	REV R1																		

# Mouser Electronics

Authorized Distributor

Click to View Pricing, Inventory, Delivery & Lifecycle Information:

[TE Connectivity:](#)

[2-1589473-1](#)