

THIS DRAWING IS UNPUBLISHED. RELEASED FOR PUBLICATION
 © COPYRIGHT - By - ALL RIGHTS RESERVED.

REVISIONS					
P	LTR	DESCRIPTION	DATE	DWN	APVD
R		REVISED PER ECO-17-002209	11APR2017	RS	MM
S		REVISED PER ECO-20-001323	17JUN2020	SM	JO

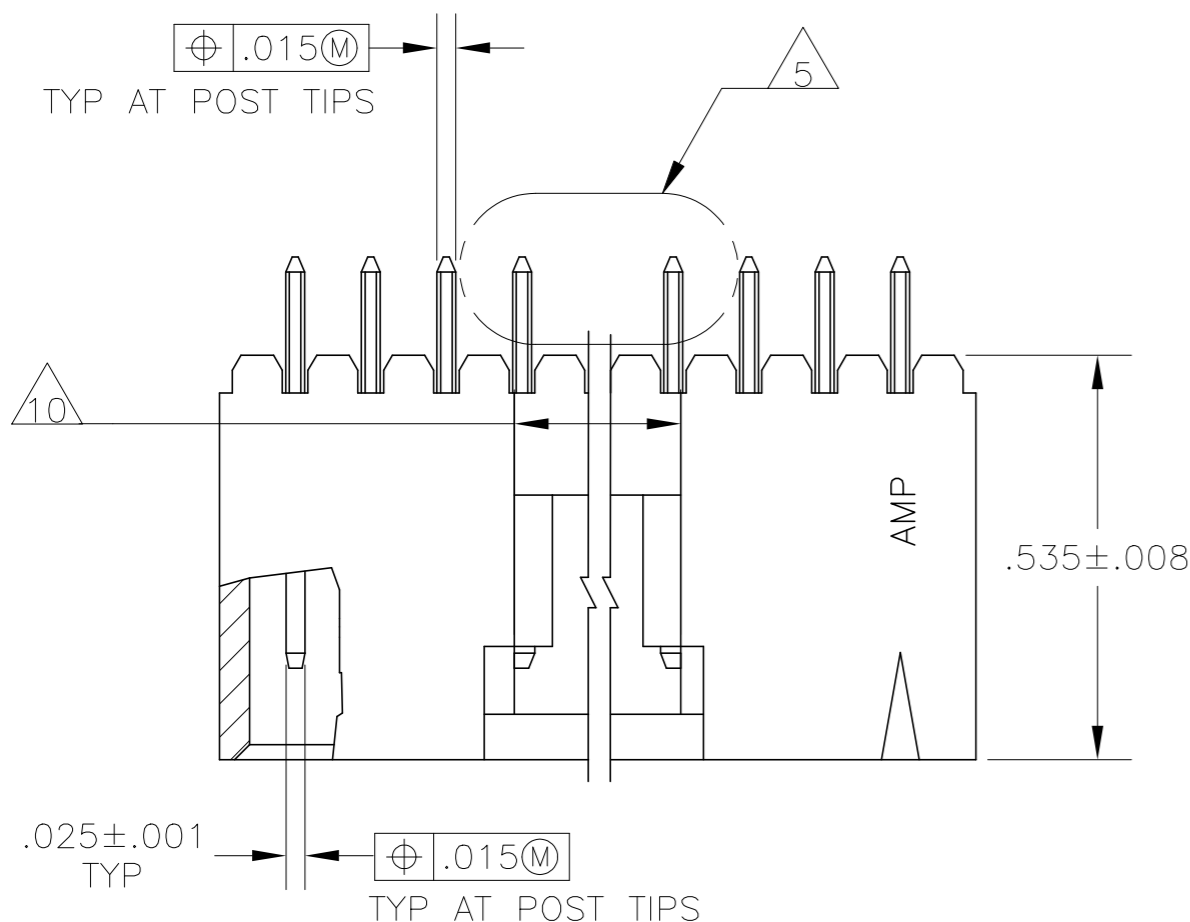

- 1 .000030 GOLD IN THE CONTACT AREA, .000100-.000200 MATTE TIN-LEAD ON THE SOLDER TAIL, ALL OVER .000050 NICKEL
- 2 POINT OF MEASUREMENT FOR PLATING THICKNESS
- 3 THESE DIMENSIONS APPLY WHERE THE POST INTERSECTS THE HOUSING
- 4 ON ASSEMBLIES WITH FOUR OR MORE POSITIONS, TWO POLARIZATION SLOTS. ON ASSEMBLIES WITH TWO OR THREE POSITIONS, ONE POLARIZATION SLOT.
- 5 SELECT POST TAILS FORMED TO PROVIDE CONNECTOR HOLD DOWN UNTIL SOLDERED. CONFIGURATION ACCEPTS .027-.080 THICK PRINTED CIRCUIT BOARD. (SEE DETAIL Z)
- 6 .000030 GOLD IN THE CONTACT AREA, .000100-.000200 MATTE TIN ON THE SOLDER TAIL, ALL OVER .000050 NICKEL
- 7 HIGH TEMPERATURE CONFIGURATION
- 8 STANDOFFS NOT PRESENT ON UNDERSIDE OF ASSEMBLY
- 9 OBSOLETE PARTS: OBSOLETE CIS STREAMLINING PER D.RENAUD/D.SINISI
- 10 .010 RECESS PERMISSIBLE IN THIS AREA FOR MOLD SHUT OFF

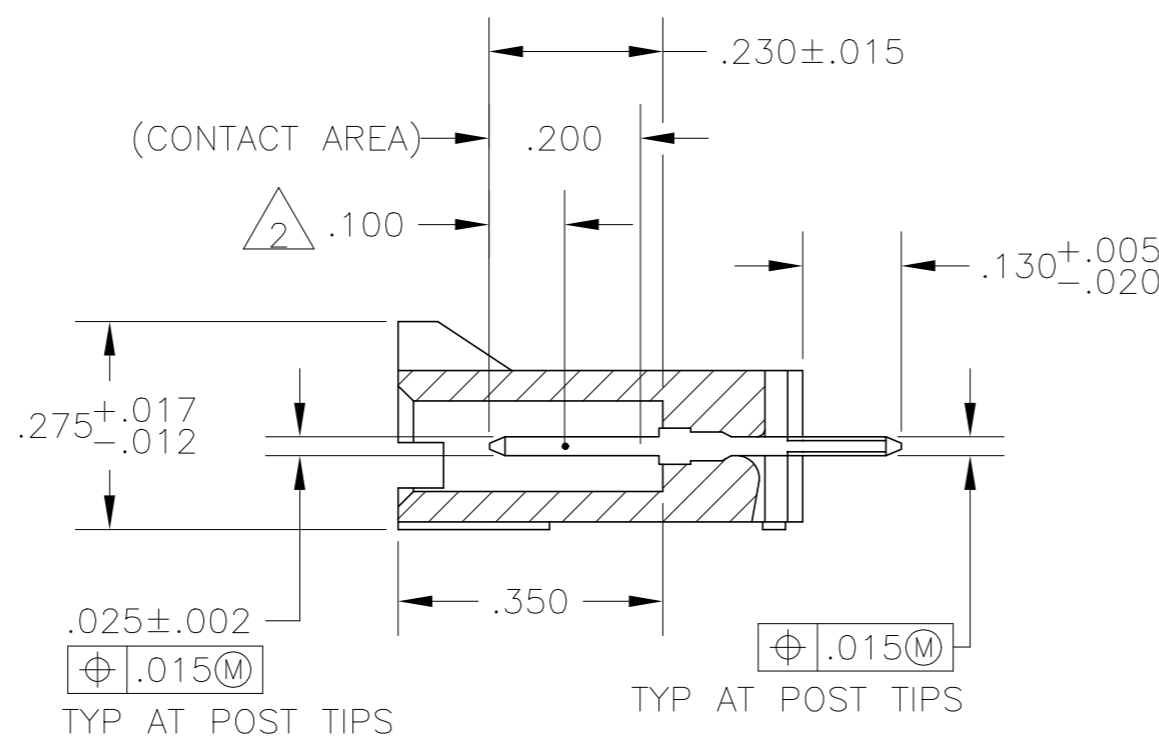
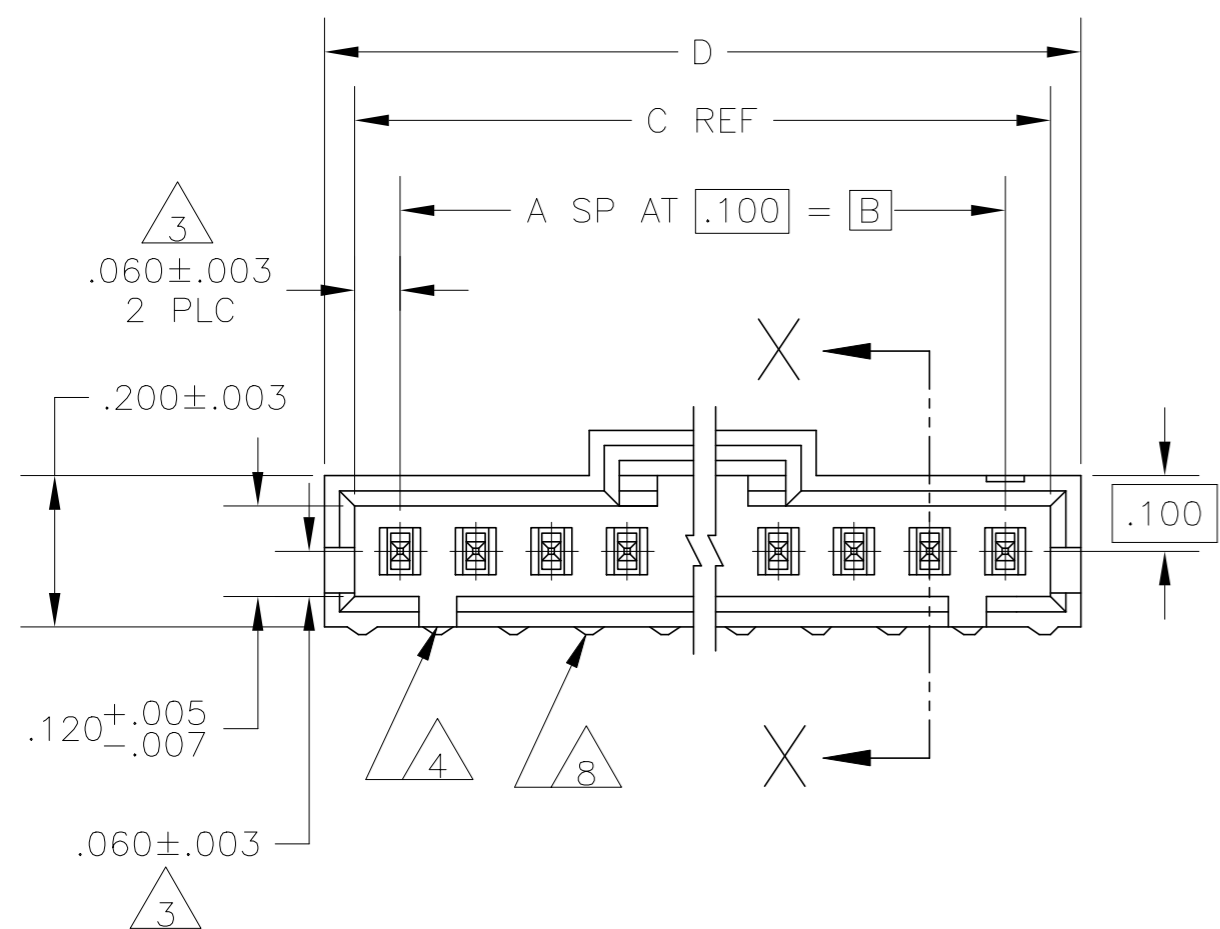

SECTION X-X

DETAIL Z
 POST DETAIL TYP
 2 POST MINIMUM

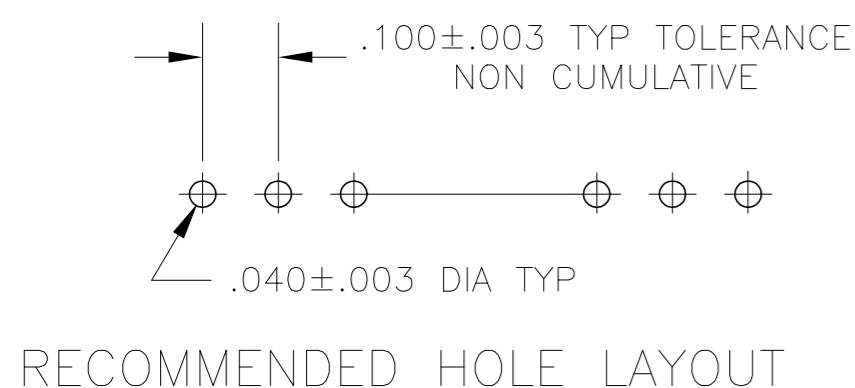

REMARKS	PLATING	D	C	B	A	NO OF POSN	ASSEMBLY PART NUMBER	
9	7 8	6	2.595	2.520	2.400	24	25	7-103908-4
9	7 8	6	2.495	2.420	2.300	23	24	7-103908-3
9	7 8	6	2.395	2.320	2.200	22	23	7-103908-2
9	7 8	6	2.295	2.220	2.100	21	22	7-103908-1
9	7 8	6	2.195	2.120	2.000	20	21	7-103908-0
9	7 8	6	2.095	2.020	1.900	19	20	6-103908-9
9	7 8	6	1.995	1.920	1.800	18	19	6-103908-8
9	7 8	6	1.895	1.820	1.700	17	18	6-103908-7
9	7 8	6	1.795	1.720	1.600	16	17	6-103908-6
9	7 8	6	1.695	1.620	1.500	15	16	6-103908-5
9	7 8	6	1.595	1.520	1.400	14	15	6-103908-4
9	7 8	6	1.495	1.420	1.300	13	14	6-103908-3
9	7 8	6	1.395	1.320	1.200	12	13	6-103908-2
9	7 8	6	1.295	1.220	1.100	11	12	6-103908-1
9	7 8	6	1.195	1.120	1.000	10	11	6-103908-0
9	7 8	6	1.095	1.020	.900	9	10	5-103908-9
9	7 8	6	.995	.920	.800	8	9	5-103908-8
9	7 8	6	.895	.820	.700	7	8	5-103908-7
9	7 8	6	.795	.720	.600	6	7	5-103908-6
9	7 8	6	.695	.620	.500	5	6	5-103908-5
9	7 8	6	.595	.520	.400	4	5	5-103908-4
9	7 8	6	.495	.420	.300	3	4	5-103908-3
9	7 8	6	.395	.320	.200	2	3	5-103908-2
9	7 8	6	.295	.220	.100	1	2	5-103908-1
9	8	1	2.595	2.520	2.400	24	25	2-103908-4
9	8	1	2.495	2.420	2.300	23	24	2-103908-3
9	8	1	2.395	2.320	2.200	22	23	2-103908-2
9	8	1	2.295	2.220	2.100	21	22	2-103908-1
9	8	1	2.195	2.120	2.000	20	21	2-103908-0
9	8	1	2.095	2.020	1.900	19	20	1-103908-9
9	8	1	1.995	1.920	1.800	18	19	1-103908-8
9	8	1	1.895	1.820	1.700	17	18	1-103908-7
9	8	1	1.795	1.720	1.600	16	17	1-103908-6
9	8	1	1.695	1.620	1.500	15	16	1-103908-5
9	8	1	1.595	1.520	1.400	14	15	1-103908-4
9	8	1	1.495	1.420	1.300	13	14	1-103908-3
9	8	1	1.395	1.320	1.200	12	13	1-103908-2
9	8	1	1.295	1.220	1.100	11	12	1-103908-1
9	8	1	1.195	1.120	1.000	10	11	1-103908-0
9	8	1	1.095	1.020	.900	9	10	103908-9
9	8	1	.995	.920	.800	8	9	103908-8
9	8	1	.895	.820	.700	7	8	103908-7
9	8	1	.795	.720	.600	6	7	103908-6
9	8	1	.695	.620	.500	5	6	103908-5
9	8	1	.595	.520	.400	4	5	103908-4
9	8	1	.495	.420	.300	3	4	103908-3
9	8	1	.395	.320	.200	2	3	103908-2
9	8	1	.295	.220	.100	1	2	103908-1

THIS DRAWING IS A CONTROLLED DOCUMENT.

DIMENSIONS: INCHES

TOLERANCES UNLESS OTHERWISE SPECIFIED:

0 PLC	± -
1 PLC	± -
2 PLC	± -
3 PLC	± .005
4 PLC	± -
ANGLES	± -

MATERIAL HOUSING: FLAME RETARDENT LCP COLOR-BLACK CONTACTS-BRASS

FINISH: SEE TABLE

APVD: PG deJONG 7-28-86

NAME: PG deJONG

PRODUCT SPEC: -

APPLICATION SPEC: -

WEIGHT: -

CUSTOMER DRAWING

SCALE: 4:1

SHEET: 1 of 1

REV: S

TE Connectivity

HEADER ASSY, AMPMODU MTE, VERTICAL, SINGLE ROW, .100 CL, .025 SQ POSTS WITH LATCH & RETENTIVE POSTS

SIZE: A2 CAGE CODE: 00779 DRAWING NO: C=103908

Mouser Electronics

Authorized Distributor

Click to View Pricing, Inventory, Delivery & Lifecycle Information:

[TE Connectivity:](#)

[5-103908-3](#)