

REVISIONS					
P	LTR	DESCRIPTION	DATE	DWN	APVD
	10	INITIAL RELEASE	11FEB2020	GK	AK

NOTES: -

1. CHARACTERS: -

0-9, A-Z, +, -, /, ~, ≡

0, 1, 6 & 9 FOLLOWED BY A FULL STOP.

HEIGHT 2.5 - 2.8 mm

TOLERANCE (AXIAL) ±0.75

(ROTATIONAL) ±5°

CHEVRON CUT MARKERS: -

CHARACTERS TO BE CENTRALLY DISPOSED ON MARKER FACE AND IN THE ATTITUDE SHOWN RELATIVE TO CHEVRON.

2. MARKER LENGTHS (DIMENSION 'A'): -

WITH SINGLE MARK 4.00 - 4.75

WITH DOUBLE MARK 6.75 - 7.25

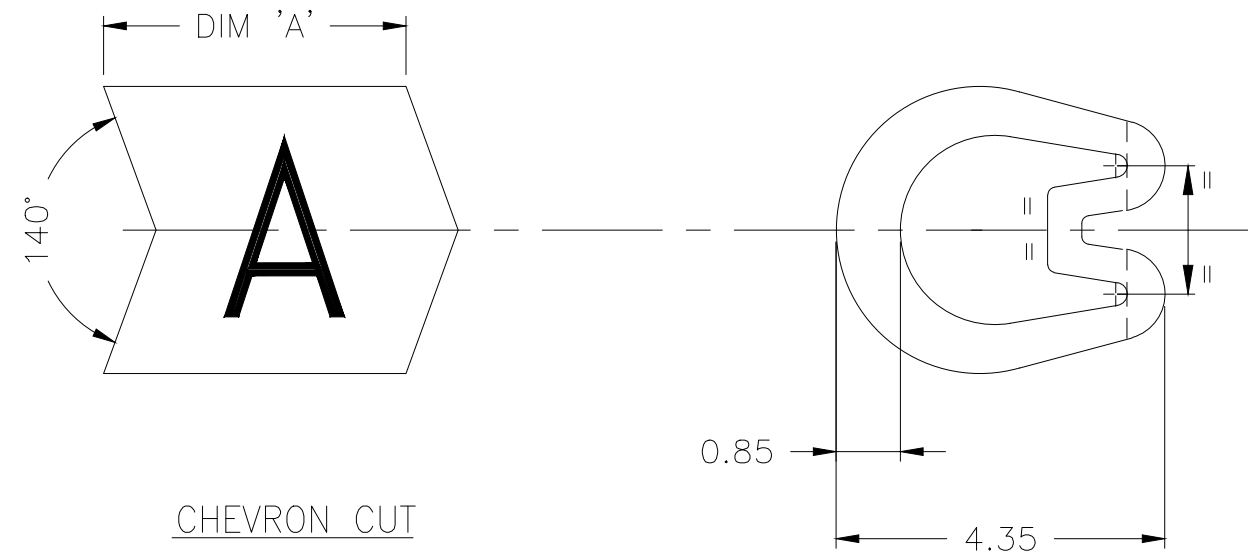

CHEVRON CUT

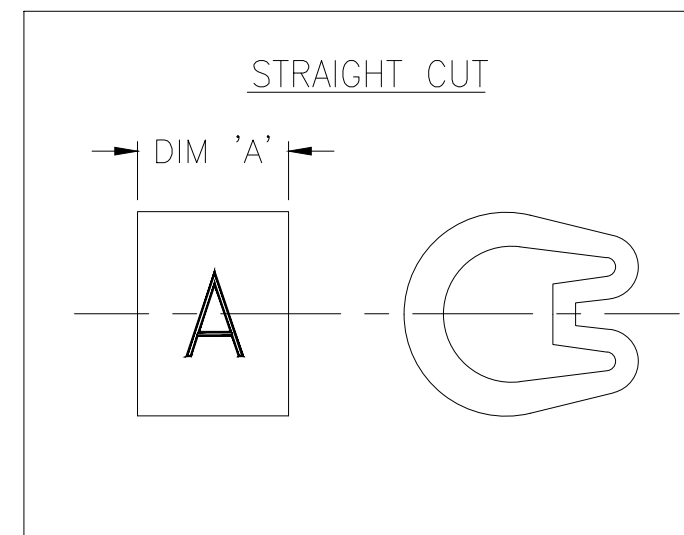

STRAIGHT CUT

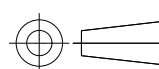
THIS DRAWING IS A CONTROLLED DOCUMENT.		DWN GOPALAKRISHNA H V 11FEB2020	 TE Connectivity				
DIMENSIONS: mm		CHK ALAN KEAN 11FEB2020					
		APVD ALAN KEAN 11FEB2020	NAME MARKER Z TYPE SIZE 9 STRAIGHT / CHEVRON CUT				
TOLERANCES UNLESS OTHERWISE SPECIFIED:		PRODUCT SPEC	-				
0 PLC ± - 1 PLC ± 0.2 2 PLC ± - 3 PLC ± - 4 PLC ± - ANGLES ± -		APPLICATION SPEC	-				
MATERIAL PVC 2.4 - 2.2g/250mm		FINISH -	WEIGHT -	SIZE A3	CAGE CODE 00779	DRAWING NO C-1601A0003	RESTRICTED TO -
CUSTOMER DRAWING			SCALE 10:1	SHEET 1 OF 1	REV 10		

Mouser Electronics

Authorized Distributor

Click to View Pricing, Inventory, Delivery & Lifecycle Information:

[TE Connectivity:](#)

[EC0506-000](#)