

THIS DRAWING AND THE INFORMATION SET FORTH HEREON ARE THE PROPERTY OF TYCO ELECTRONICS AND ARE TO BE HELD IN TRUST AND CONFIDENCE. PUBLICATION, DUPLICATION, DISCLOSURE, OR USE FOR ANY PURPOSE NOT EXPRESSLY AUTHORIZED IN WRITING BY TYCO ELECTRONICS IS PROHIBITED.

REVISIONS			
LTR	DESCRIPTION	DATE	APPROVED
A	INITIAL RELEASE PER ECO-11-022898	11/14/11	B. WONG



SPIN-LOCK ADAPTER, HEAT SHRINKABLE MOLDED PART, SEALED

NOTES:

- THIS PRODUCT IS DESIGNED TO TERMINATE A BRAIDED CABLE SHIELD AND A HEAT SHRINKABLE LIPPED BOOT TO A CONNECTOR.
- SEE DRAWING "TR" FOR DETAIL ON TINEL-LOCK RING. RINGS ARE DESIGNED TO BE HEATED ELECTRICALLY. ALL RINGS ARE MARKED WITH THERMOCHROMIC PAINT WHICH CHANGES COLOR WHEN INSTALLATION TEMPERATURE IS REACHED.
- ADAPTER TO BE PERMANENTLY MARKED WITH CODE IDENT. NO. AND PART NO. LESS RING DESIGNATOR (E.G.: 06090-XXXXXXX-XXXXX).
- ADAPTER MATES TO MIL-C-38999, SERIES III & IV, CLASS C, F, K, & W; D38999 /20, /24, /26, /40, /46, /47 CONNECTORS, WHEN SO MATED SHALL PROVIDE WATER-TIGHT SEAL MEETING THE REQUIREMENTS OF MIL-C-85049, PAR. 3.5.7.
- INSTALLATION PROCEDURE MIP-104.
- PERFORMANCE SPECIFICATION MPS-103.
- FOR ADDITIONAL ORDERING INFORMATION SEE CH00-0250-019

©2011 Tyco Electronics Corporation. All rights reserved.

If this document is printed it becomes uncontrolled. Check for the latest revision

Raychem Adapters  
CUSTOMER DRAWING

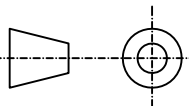
UNLESS OTHERWISE SPECIFIED DIMENSIONS ARE IN INCHES AND TOLERANCES ARE: .XXX ± .06 .XX ± .03 ± 2°	DRAWN D JAIN	DATE 12OCT2011		TE Connectivity	
	CHECKED BERT W	DATE 12OCT2011			
	APPROVED	DATE			
MATERIAL SEE NOTES	THIRD ANGLE PROJECTION 		TITLE SPIN-LOCK ADAPTER, HEAT SHRINKABLE MOLDED PART, SEALED, CODE 40		
FINISH -	CAD NAME SLM40_a.dwg	SIZE A	CAGE CODE: 06090	DWG. NO. SLM40	REV A
	RPN: -	SCALE: NONE		SHEET 1 OF 3	

REVISIONS			
LTR	DESCRIPTION	DATE	APPROVED
A	INITIAL RELEASE PER ECO-11-022898	11/14/11	B. WONG



Raychem Adapters  
**CUSTOMER DRAWING**

SIZE A	CAGE CODE: 06090	DWG. NO. SLM40	REV A
SCALE: NONE		SHEET 2 OF 3	

REVISIONS			
LTR	DESCRIPTION	DATE	APPROVED
A	INITIAL RELEASE PER ECO-11-022898	11/14/11	B. WONG

TABLE I

ORDER NO.	SHELL SIZE 4		AVAILABLE ENTRY SIZES SEE TABLE III		A METRIC CLASS	B MAX DIA	C MAX DIM
	COM'L	MIL	SMALL	LARGE			
08	09	A	04	-	M12 x 1.0	.67 [17.02]	.61 [15.49]
10	11	B	04	06	M15 x 1.0	.81 [20.57]	.66 [16.76]
12	13	C	06	08	M18 x 1.0	.96 [24.38]	.73 [18.54]
14	15	D	08	10	M22 x 1.0	1.14 [28.96]	.86 [21.84]
16	17	E	10	12	M25 x 1.0	1.25 [31.75]	.92 [23.37]
18	19	F	10	14	M28 x 1.0	1.40 [35.56]	.98 [24.89]
20	21	G	12	16	M31 x 1.0	1.48 [37.59]	.99 [25.15]
22	23	H	14	18	M34 x 1.0	1.61 [40.89]	1.06 [26.92]
24	25	J	16	20	M37 x 1.0	1.75 [44.45]	1.12 [28.45]

TABLE II

ORDER NO.	D MAX DIM	E MAX DIM	F MAX DIM	G MAX DIM	H MAX DIM	I MAX DIA	J MAX DIM
08	1.93 [49.02]	2.45 [62.23]	1.46 [37.08]	1.84 [46.74]	1.03 [26.16]	.55 [13.97]	1.18 [29.97]
10	2.28 [57.91]	2.99 [75.95]	1.65 [41.91]	2.33 [59.18]	1.37 [34.80]	.68 [17.27]	1.39 [35.31]
12	2.35 [59.69]	3.06 [77.72]	1.72 [43.69]	2.33 [59.18]	1.37 [34.80]	.68 [17.27]	1.47 [37.34]
14	2.63 [66.80]	3.41 [86.61]	1.97 [50.04]	2.55 [64.77]	1.52 [38.61]	.90 [22.86]	1.68 [42.67]
16	2.69 [68.33]	3.47 [88.14]	2.03 [51.56]	2.55 [64.77]	1.52 [38.61]	.90 [22.86]	1.74 [44.20]
18	2.97 [75.44]	3.87 [98.30]	2.23 [56.64]	2.90 [73.66]	1.77 [44.96]	1.11 [28.19]	1.95 [49.53]
20	2.98 [75.69]	3.89 [98.81]	2.24 [56.90]	2.90 [73.66]	1.77 [44.96]	1.11 [28.19]	1.99 [50.55]
22	3.43 [87.12]	4.43 [112.52]	2.52 [64.01]	3.36 [85.34]	2.16 [54.86]	1.35 [34.29]	2.27 [57.66]
24	3.49 [88.65]	4.48 [113.79]	2.58 [65.53]	3.36 [85.34]	2.16 [54.86]	1.35 [34.29]	2.33 [59.18]

TABLE III

ENTRY SIZE	MOLDED PART DESCRIPTION	S DIA	Z +.010 -.020
04	245W032	.376 [9.55] .370 [9.40]	.250 [6.35]
06	245W042	.501 [12.73] .495 [12.57]	.375 [9.53]
08	245W042	.626 [15.90] .619 [15.72]	.500 [12.70]
10	245W053	.752 [19.10] .742 [18.85]	.625 [15.88]
12	245W053	.877 [22.28] .867 [22.02]	.750 [19.05]
14	245W063	1.002 [25.45] .991 [25.17]	.875 [22.23]
16	245W063	1.127 [28.63] 1.116 [28.35]	1.000 [25.40]
18	245W074	1.252 [31.80] 1.241 [31.52]	1.125 [28.58]
20	245W074	1.377 [34.98] 1.366 [34.70]	1.250 [31.75]

Raychem Adapters

CUSTOMER DRAWING

SIZE A	CAGE CODE: 06090	DWG. NO. SLM40	REV A
			SHEET 3 OF 3

# Mouser Electronics

Authorized Distributor

Click to View Pricing, Inventory, Delivery & Lifecycle Information:

[TE Connectivity:](#)

[SLM40AB-2420A-3/42-0](#)