

Thermofit[®] Molded Parts Specification Control Drawing

Part Number : 207W613 thru 667
Description : Boot, Straight

NOTES

- All dimensions are in $\frac{\text{inches}}{\text{[millimeters]}}$
- Dimensions appearing in table are as follows:
 - a - As Supplied
 - b - After Unrestricted Recovery
- Coating is optional. As supplied dimensions appearing in table are for uncoated parts. When coating is added, entry diameters will be reduced by .06 max.

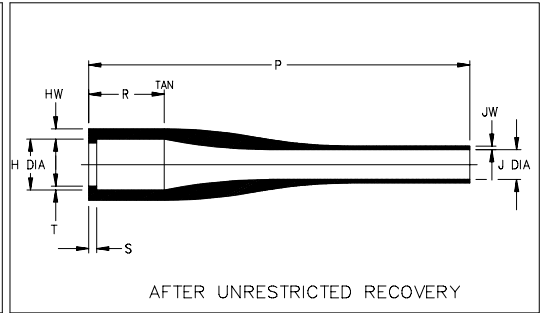
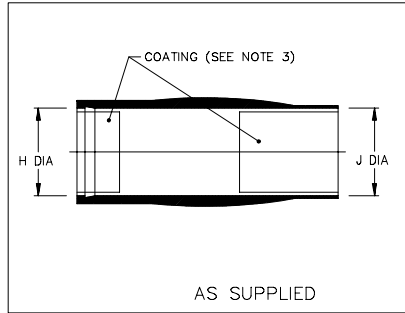

PART NUMBER	H		J		P ±10%	R ±10%	S ±10%	T ±10%	HW ±20%	JW ±20%
	Min	Max	Min	Max						
	a	b	a	b						
207W613	.84 [21,3]	.55 [14,0]	.66 [16,8]	.21 [5,3]	5.30 [134,6]	1.10 [27,9]	.12 [3,0]	.06 [1,5]	.16 [4,1]	.04 [1,0]
207W623	1.00 [25,4]	.65 [16,5]	1.00 [25,4]	.33 [8,4]	6.00 [152,4]	1.20 [30,5]	.12 [3,0]	.06 [1,5]	.16 [4,1]	.06 [1,5]
207W634	1.30 [33,0]	.80 [20,3]	1.30 [33,0]	.43 [10,9]	6.00 [152,4]	1.20 [30,5]	.12 [3,0]	.06 [1,5]	.16 [4,1]	.06 [1,5]
207W644	1.70 [43,2]	.90 [22,9]	1.70 [43,2]	.56 [14,2]	6.90 [175,3]	1.50 [38,1]	.12 [3,0]	.06 [1,5]	.16 [4,1]	.08 [2,0]
207W656	2.10 [53,3]	1.10 [27,9]	2.10 [27,9]	.70 [17,8]	6.90 [175,3]	1.50 [38,1]	.12 [3,0]	.06 [1,5]	.16 [4,1]	.08 [2,0]
207W667	2.85 [72,4]	1.45 [36,8]	2.85 [72,4]	.95 [24,1]	7.24 [183,9]	1.60 [40,6]	.12 [3,0]	.06 [1,5]	.20 [5,1]	.10 [2,5]

Raychem

RAYCHEM CORPORATION
300 CONSTITUTION DRIVE
MENLO PARK, CALIFORNIA 94025
(415) 361-6055

Revision : L
Date : 9/17/92

Part Number : 207W613 thru 667
Description : Boot, Straight

Thermofit[®] Molded Parts Specification Control Drawing

Part Number : 207W613 thru 667
Description : Boot, Straight

MATERIAL DASH NO.	MATERIAL DESCRIPTION	RT SPEC	COATING SLASH NO.	COATING S NO.	COATING DESCRIPTION
-3	Polyolefin, Semi-rigid	RT-301	N/A		
-4	Polyolefin, Flexible	RT-1304	N/A		
-25	Elastomer, Fluid Resistant	RT-1325	/42;/86	S-1017;S-1048	Adhesive
-100	Polyolefin, Semi-flexible ZEROHAL [™]	RT-1323	/86;/184	S-1048;S-1030	Adhesive

*VITON is a Registered Trademark of Dupont

ORDERING INFORMATION

207W6XX -X -XX /XXX

Base part number _____

Material dash number _____
(See Compatability Chart)

Modification number _____
(If necessary, see front of scd binder
for a complete list)

Adhesive slash number _____
(If necessary, see Compatability Chart)

THIS DRAWING IS SUBJECT TO CHANGE WITHOUT NOTICE; CONSULT YOUR
NEAREST FIELD REPRESENTATIVE FOR CURRENT REVISION

Raychem

RAYCHEM CORPORATION
300 CONSTITUTION DRIVE
MENLO PARK, CALIFORNIA 94025
(415) 361-6055

Revision : L
Date : 9/17/92

Part Number : 207W613 thru 667
Description : Boot, Straight

CAD FILE MP92427

If this document is printed it becomes uncontrolled.
Check for the latest revision.

Mouser Electronics

Authorized Distributor

Click to View Pricing, Inventory, Delivery & Lifecycle Information:

[TE Connectivity:](#)

[207W613-100/184-0-CS5657](#)