

# Vertical Cavity Surface Emitting Laser



OPV300, OPV310, OPV310Y, OPV314, OPV314Y

## Features:

- 850nm VCSEL Technology
- Data rates up to 2.5 Gbps
- High thermal stability
- Low drive current / high output density
- Narrow and concentric beam angle
- Recommended for multimode fiber applications
- Burned in for communication level reliability



## Description:

The **OPV300 / OPV310 / OPV314** series are high performance 850nm Vertical Cavity Surface Emitting Laser (VCSEL). The **OPV300** and **OPV310** are designed to be utilized for sensing applications as well as air transmission of data. The **OPV314** is designed for high speed communication links. The **OPV310 / OPV314** combine all the performance advantages of a VCSEL with the addition of a power monitor diode for precise control of optical power. The **OPV310 and OPV314** have a back monitor photodiode used for optical power management or optical reception for data communication applications.

The **OPV300 / OPV310** have a flat lens while the **OPV314** has a microbead lens. Refer to mechanical drawings for details.

The high performance 850nm VCSEL is designed for applications where low current is required with high on-axis optical power. These product's combine features including high speed, high output optical power and concentric beam making it an ideal transmitter for integration into all types of data communications equipment as well as for reflective and transmissive switches.

## Applications:

- Fiber Channel
- Gigabit Ethernet
- ATM
- VSR
- Intra-System links
- Optical backplane interconnects
- Reflective sensing
- Interruptive sensing
- Long distance spot illumination

**NOTICE**

This component is sensitive to electrostatic discharge (ESD). To prevent ESD-induced damage and/or degradation to equipment, take normal ESD precautions when handling this product.



RoHS



Additional laser safety information can be found on the Optek website. See application bulletin #221. Classification is not marked on the device due to space limitations. See package outline for center-line of optical radiance. Operating devices beyond maximum rating may result in hazardous radiation exposure.

## General Note

TT Electronics reserves the right to make changes in product specification without notice or liability. All information is subject to TT Electronics' own data and is considered accurate at time of going to print.

TT Electronics | OPTeK Technology, Inc.  
1645 Wallace Drive, Suite 130, Carrollton, TX 75006 | Ph: +1 972-323-2200  
www.ttelectronics.com | sensors@ttelectronics.com

# Vertical Cavity Surface Emitting Laser



OPV300, OPV310, OPV310Y, OPV314, OPV314Y

## Electrical Specifications

### Absolute Maximum Ratings ( $T_A = 25^\circ\text{C}$ unless otherwise noted)

Operating Temperature Range	0°C to +70°C
Storage Temperature Range	-40°C to +100°C
Maximum Forward Peak Current, continuous	12 mA
Maximum Reverse Voltage	5 V
Max. Continuous Optical Power at 70° C	1.1 mW
Lead Soldering Temperature	260°C for 10 sec.
Maximum Forward Current, pulsed (1 $\mu\text{s}$ P.W., 10% D.C.)	48 mA

#### Notes:

- (1) Threshold Current is based on the two line intersection method specified in Telcordia GR-468-Core. Line 1 from 4 mA to 6 mA. Line 2 from 0 mA to 0.5 mA.
- (2) Series Resistance is the slope of the Voltage-Current line from 5 to 8 mA.
- (3) Slope efficiency is the slope of the best fit LI line from 5 mA to 8 mA using no larger than .25 mA test interval points.
- (4) Using data points taken for slope efficiency above,  $\Delta L/\Delta I$  shall be calculated for each adjacent pair of points.



Additional laser safety information can be found on the Optek website. See application bulletin #221. Classification is not marked on the device due to space limitations. See package outline for center-line of optical radiance. Operating devices beyond maximum rating may result in hazardous radiation exposure.

#### General Note

TT Electronics reserves the right to make changes in product specification without notice or liability. All information is subject to TT Electronics' own data and is considered accurate at time of going to print.

TT Electronics | OPTEK Technology, Inc.  
1645 Wallace Drive, Suite 130, Carrollton, TX 75006 | Ph: +1 972-323-2200  
www.ttelectronics.com | sensors@ttelectronics.com

# Vertical Cavity Surface Emitting Laser



OPV300, OPV310, OPV310Y, OPV314, OPV314Y

## Electrical Specifications

Electrical Characteristics ( $T_A = 25^\circ\text{C}$  unless otherwise noted)

Symbol	Parameter	Min	Typ	Max	Units	Test Conditions
$P_{OT}$	Total Power Out OPV300 / OPV310 OPV314	1.50 1.40			mW	$I_F = 7\text{ mA}$
$I_{TH}$	Threshold Current	0.80		3.00	mA	Note 1
$V_F$	Forward Voltage	1.60		2.20	V	$I_F = 7\text{ mA}$
$I_R$	Reverse Current			100	nA	$V_R = 5\text{ V}$
$R_S$	Series Resistance	20		55	ohms	Note 2
$\eta$	Slope Efficiency	0.28		0.60	mW/mA	Note 3
	Linearity	0.00				Note 4
$\lambda$	Wavelength	840	850	860	nm	
$\Delta\lambda$	Optical Bandwidth			0.85	nm	
$\theta$	Beam Divergence (OPV300 / OPV310 only)		24		Degree	$I_F = 7\text{ mA}$ , FWHM
$t_r/t_f$	Rise and Fall Time		100		ps	20% to 80%
$N_{RI}$	Relative Intensity Noise		-123		dB/Hz	
$\Delta I_{TH}$	Temp Variance of Threshold Current		$\pm 1.0$		mA	$0^\circ - 70^\circ\text{C}$ , Note 1
$\Delta\lambda/\Delta T$	Temp Coefficient of Wavelength		0.06		nm/ $^\circ\text{C}$	$0^\circ - 70^\circ\text{C}$ , $I_F = 7\text{ mA}$
$\Delta V_F/\Delta T$	Temperature Coefficient for VF		-2.5		mV/ $^\circ\text{C}$	$0^\circ - 70^\circ\text{C}$ , $I_F = 7\text{ mA}$
$\Delta\eta/\Delta T$	Temperature Coefficient for Efficiency		-0.5		%/ $^\circ\text{C}$	$0^\circ - 70^\circ\text{C}$ , Note 3
<b>Photodiode Electrical Characteristics (OPV310/OPV314 series)</b>						
$I_{RPD}$	Reverse Current, photodiode			30	nA	$V_R = 5\text{ V}$
$I_{M1}$	Monitor Current OPV310 OPV314	30 40			$\mu\text{A}$	$I_F = 7\text{ mA}$ , $V_R = 5\text{ V}$
$I_{M2}$	Monitor Current OPV310 OPV314	40 45			$\mu\text{A}$	$P_O = 2\text{ mW}$ , $V_R = 5\text{ V}$

### NOTES:

- Threshold Current is based on the two line intersection method specified in Telcordia GR-468-Core. Line 1 from 4 mA to 6 mA. Line 2 from 0 mA to 0.5 mA.
- Series Resistance is the slope of the Voltage-Current line from 5 to 8 mA.
- Slope efficiency, is the slope of the best fit LI line from 5 mA to 8 mA using no larger than .25 mA test interval points.
- Using data points taken for slope efficiency above,  $\Delta L/\Delta I$  shall be calculated for each adjacent pair of points.
- ESD Class 1

### General Note

TT Electronics reserves the right to make changes in product specification without notice or liability. All information is subject to TT Electronics' own data and is considered accurate at time of going to print.

TT Electronics | OPTEK Technology, Inc.  
1645 Wallace Drive, Suite 130, Carrollton, TX 75006 | Ph: +1 972-323-2200  
www.ttelectronics.com | sensors@ttelectronics.com

# Vertical Cavity Surface Emitting Laser



OPV300, OPV310, OPV310Y, OPV314, OPV314Y

## Performance

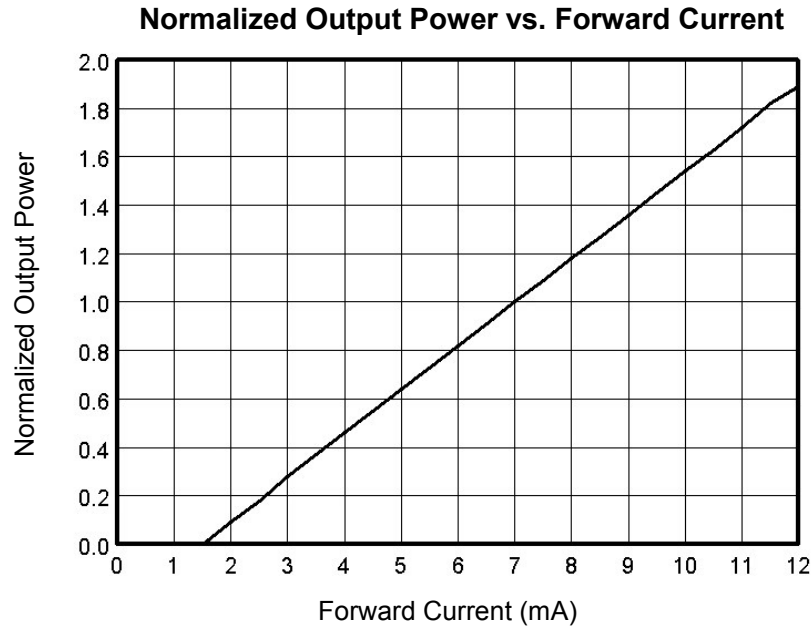

General Note  
TT Electronics reserves the right to make changes in product specification without notice or liability. All information is subject to TT Electronics' own data and is considered accurate at time of going to print.

# Vertical Cavity Surface Emitting Laser



OPV300, OPV310, OPV310Y, OPV314, OPV314Y

## Performance

### OPV300 & OPV310

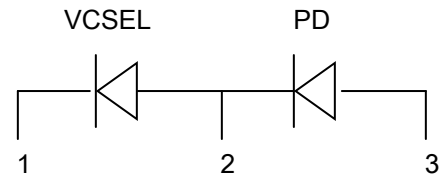
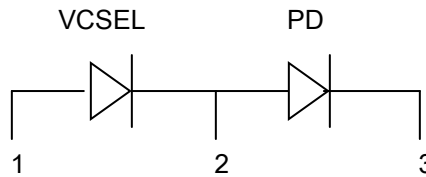
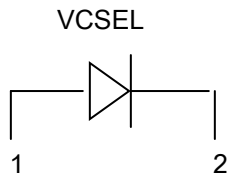
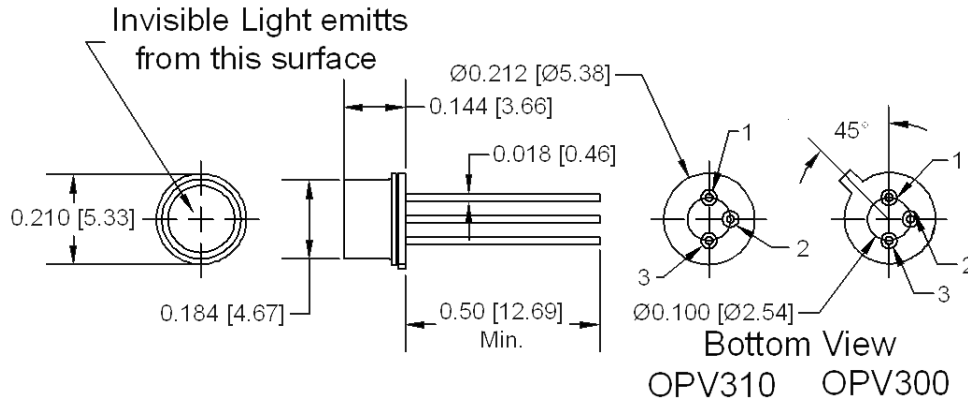

OPV300	
Pin	Connection
1	VCSEL Anode
2	VCSEL Cathode
3	No Connection

OPV310	
Pin	Connection
1	VCSEL Anode
2	VCSEL Cathode/PD Anode
3	PD Cathode

OPV310Y	
Pin	Connection
1	VCSEL Cathode
2	VCSEL Anode/PD Cathode
3	PD Anode

General Note  
 TT Electronics reserves the right to make changes in product specification without notice or liability. All information is subject to TT Electronics' own data and is considered accurate at time of going to print.

TT Electronics | OPTEK Technology, Inc.  
 1645 Wallace Drive, Suite 130, Carrollton, TX 75006 | Ph: +1 972-323-2200  
[www.ttelectronics.com](http://www.ttelectronics.com) | [sensors@ttelectronics.com](mailto:sensors@ttelectronics.com)

# Vertical Cavity Surface Emitting Laser



OPV300, OPV310, OPV310Y, OPV314, OPV314Y

## OPV314

Invisible Light emits from this surface

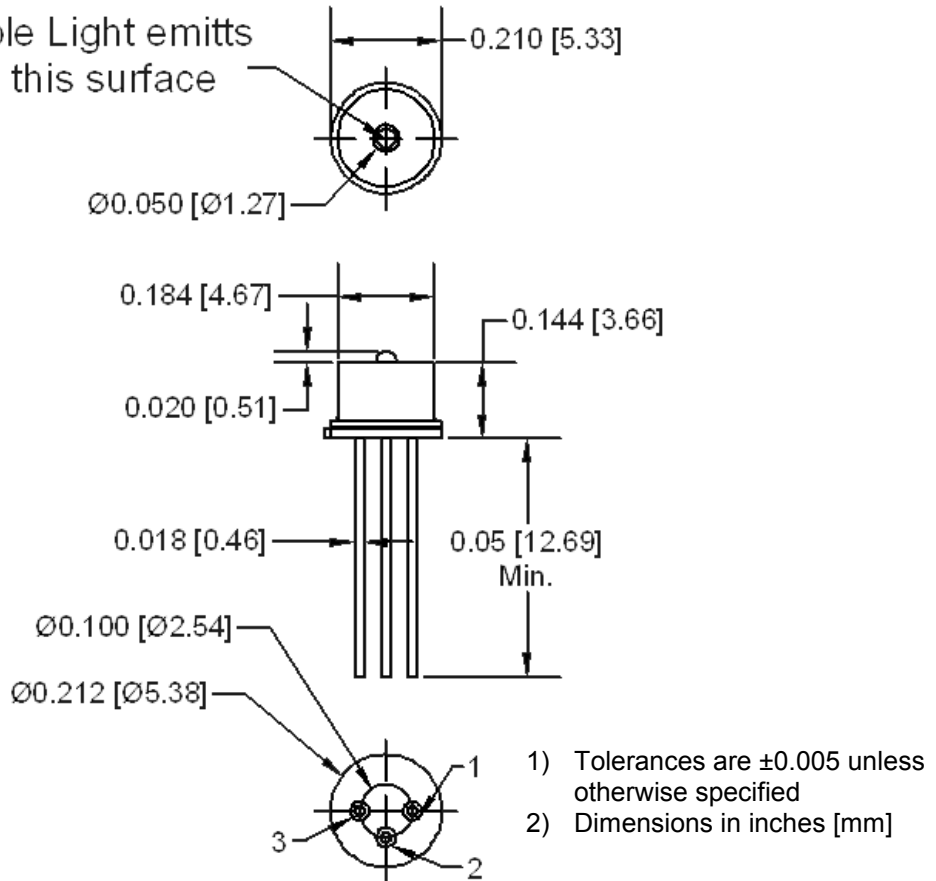

- 1) Tolerances are  $\pm 0.005$  unless otherwise specified
- 2) Dimensions in inches [mm]

Bottom View

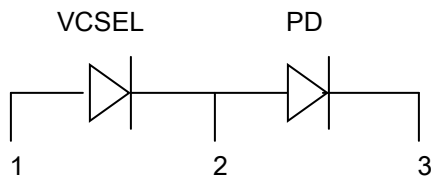

OPV314	
Pin	Connection
1	VCSEL Anode
2	VCSEL Cathode/PD Anode
3	PD Cathode

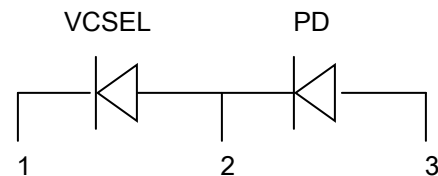

OPV314Y	
Pin	Connection
1	VCSEL Cathode
2	VCSEL Anode/PD Cathode
3	PD Anode

General Note  
TT Electronics reserves the right to make changes in product specification without notice or liability. All information is subject to TT Electronics' own data and is considered accurate at time of going to print.

TT Electronics | OPTeK Technology, Inc.  
1645 Wallace Drive, Suite 130, Carrollton, TX 75006 | Ph: +1 972-323-2200  
www.ttelectronics.com | sensors@ttelectronics.com

# Mouser Electronics

Authorized Distributor

Click to View Pricing, Inventory, Delivery & Lifecycle Information:

[TT Electronics:](#)

[OPV300](#) [OPV310](#) [OPV310Y](#) [OPV314](#)