

nanoSmart® Ultra-Low-Power Linear Regulator

DESCRIPTIONS

The TS14001 linear regulator is an ultra-low-power circuit which draws low nA level quiescent current at light load, but has the capability to regulate current loads as high as 200mA.

APPLICATIONS

- Portable electronics
- RFID
- Industrial
- Medical
- Energy harvesting systems
- SmartCard

FEATURES

- **Ultra-low nA operating current at light load**
- **Best-in-class quiescent current of 20nA at $I_{load}=0$**
- **Best-in-class quiescent current of 100pA in disable mode**
- **Output voltage options of 1.2V - 4.2V in 100mV steps (programmed at manufacturing)**
- Accurate output regulation
- Over-current protection

SUMMARY SPECIFICATIONS

- Low input operating voltage of 2.5V to 5.5V
- Packaged in a 8pin VDFN (2x2)

Block Diagram

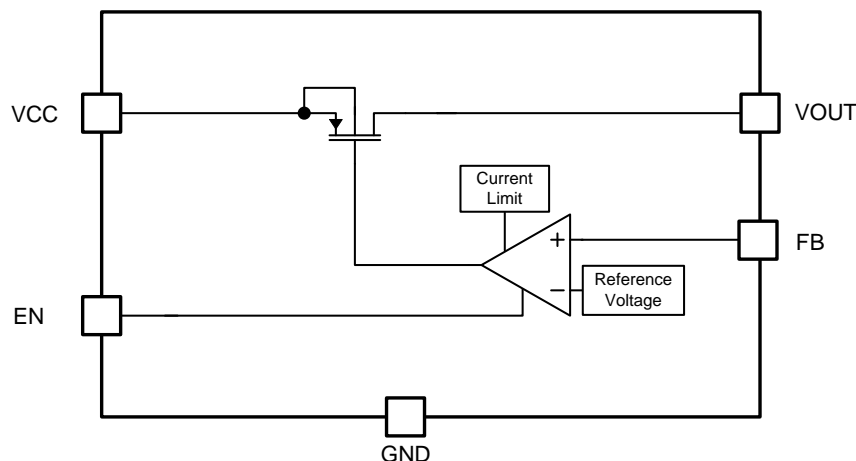

TYPICAL APPLICATION

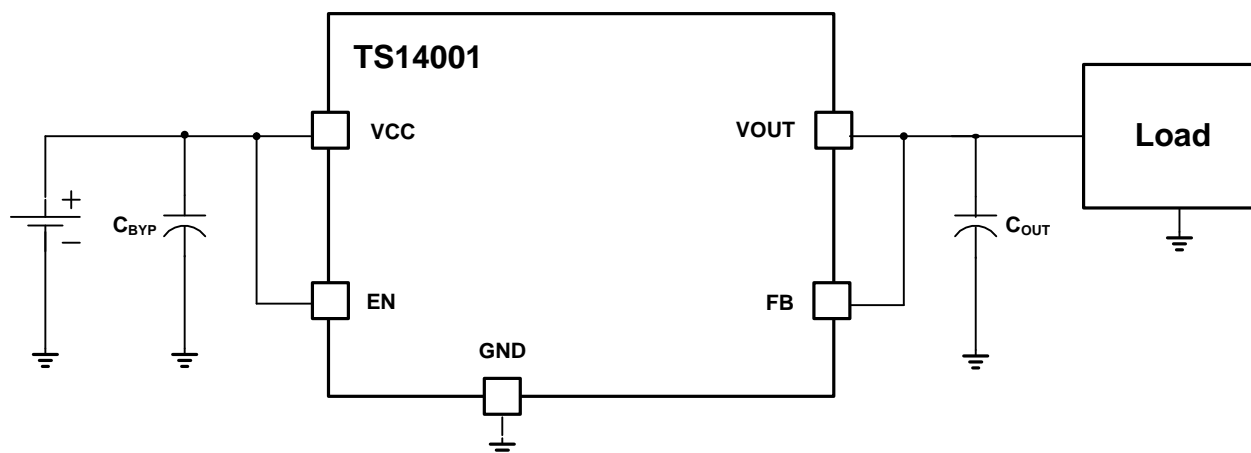

PIN-OUT CONFIGURATION

PIN #	NAME	I/O/P	DESCRIPTION
1	GND	P	Ground
2	V _{OUT}	O	Regulated Output Voltage
3	NC		No Connect (connect to GND or float)
4	NC		No Connect (connect to GND or float)
5	NC		No Connect (connect to GND or float)
6	FB	I	Feedback Input
7	V _{CC}	P	Input Power
8	EN	I	Enable Input

ABSOLUTE MAXIMUM RATINGS

Over operating free-air temperature range unless otherwise noted^(1,2,3)

PIN / PARAMETER	VALUE	UNIT
V _{CC} , V _{OUT} , EN, FB	-0.3 to 6.0	V
Electrostatic Discharge (Human Body Model)	2	kV
Operating Junction Temperature Range, T _J	-20 to 85	°C
Storage Temperature Range, T _{STG}	-65 to 150	°C
Lead Temperature (soldering, 10 seconds)	260	°C

Note 1: Stresses beyond those listed under “absolute maximum ratings” may cause permanent damage to the device. These are stress ratings only, and functional operation of the device at these or any other conditions beyond those indicated under “recommended operating conditions” is not implied. Exposure to absolute-maximum-rated conditions for extended periods may affect device reliability.

Note 2: All voltage values are with respect to network ground terminal.

Note 3: ESD testing is performed according to the respective JEDEC standard.

THERMAL CHARACTERISTICS

Package DFN	θ_{JA} (°C/W) (See Note 4)	θ_{JC} (°C/W) (See Note 5)
8 pin	73.1	10.7

Note 4: This assumes a FR4 board only.

Note 5: This assumes a 1oz. Copper JEDEC standard board with thermal vias. See Exposed Pad section and application note for more information.

RECOMMENDED OPERATING CONDITIONS

Parameter	Min	Typ	Max	Unit
Unregulated Supply Input Voltage (V_{CC})	2.5		5.5	V
Enable Input (EN)	0		5	V
Regulated Supply Output Voltage (V_{OUT}) typical	1.2		4.2	V
Operating Ambient Temperature, T_A (Note 6)	-40		55	°C
Operating Junction Temperature, T_J	-40		85	°C
Input Bypass Capacitor (C_{BYP})		2.2		uF
Output Bypass Capacitor (C_{OUT})	1	2.2	4.7	uf

Note 6: T_A Max shown here is a guideline. Higher T_A can be tolerated if T_J does not exceed the Absolute Maximum Rating.

CHARACTERISTICS

Electrical characteristics, $V_{CC} = 2.5V$ to $5V$, $T_J = 25C$, unless otherwise noted

Symbol	Parameter	Condition	Min	Typ	Max	Unit
V _{BAT}	Input Supply Voltage		2.5		5.5	V
V _{ilEN}	Input Low Logic Level				0.3*V _{CC}	V
V _{ihEN}	Input High Logic Level		0.7*V _{CC}			V
I _{qq}	Quiescent Current	$V_{CC} = 2.5V$ to $5.5V$, $I_{OUT} = 0$		20		nA
I _{qq-disable}	Quiescent Current: Disable Mode	$I_{OUT} = 0$, $EN = 0$		100		pA
I _{op-gnd}	Operating Current	$V_{CC} = V_{CC_MIN}$, $I_{OUT} = 200mA$ (Note 7)		200		uA
		$V_{CC} = V_{CC_NOM}$, $I_{OUT} = 200mA$ (Note 7)		200		uA
		$V_{CC} = V_{CC_MAX}$, $I_{OUT} = 200mA$ (Note 7)		200		uA
I _{out}	Load Capability	$V_{out_nominal}$ from 1.2V to 3.5V	0		200	mA
		$V_{out_nominal} > 3.5V$	0		100	

Note 7: If $V_{out_nominal} < 2.5V$, then $V_{CC_MIN} = 2.5V$, otherwise $V_{CC_MIN} = V_{out} + 0.3V$. V_{CC_MAX} is always 5.5V. V_{CC_NOM} is the average of V_{CC_MAX} and V_{CC_MIN} .

CHARACTERISTICS CONTINUED

Electrical characteristics, $V_{CC} = 2.5V$ to $5V$, $T_J = 25C$, unless otherwise noted

Symbol	Parameter	Condition	Min	Typ	Max	Unit
V_{Line}	DC Line Regulation	$V_{CC} = V_{CC_MIN}$ to V_{CC_MAX} , $V_{OUT} = 1.8V$ to $4.2V$, $I_{OUT} = 50mA$		0.5	4	%
		$V_{CC} = V_{CC_MIN}$ to V_{CC_MAX} , $V_{OUT} < 1.8V$, $I_{OUT} = 50mA$			4	%
V_{Load}	DC Load Regulation	$V_{CC} = V_{CC_NOM}$, $I_{OUT} = 0.02mA$ to $200mA$,		1	3	%
I_{limit}	Current Limit	I_{OUT} measured at $V_{OUT} = 0.9 * V_{out_nominal}$; $V_{out_nominal}$ from $1.2V$ to $3.5V$		250		mA
		I_{OUT} measured at $V_{OUT} = 0.9 * V_{out_nominal}$; $V_{out_nominal} > 3.5V$		175		

TYPICAL CHARACTERISTICS

I_{qq} Performance

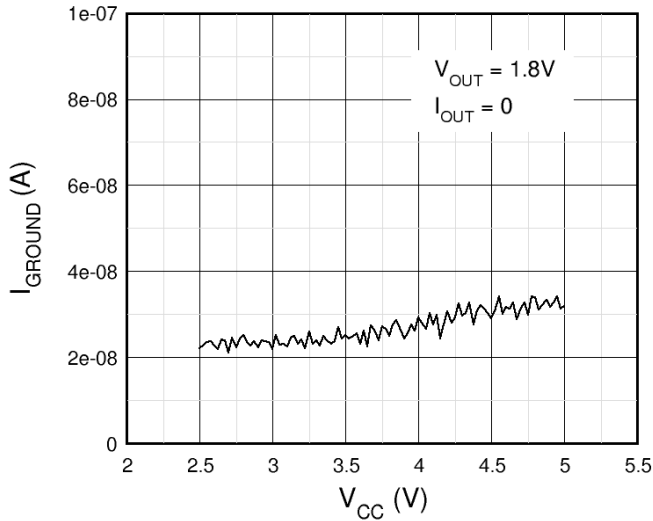

I_{qq} Performance

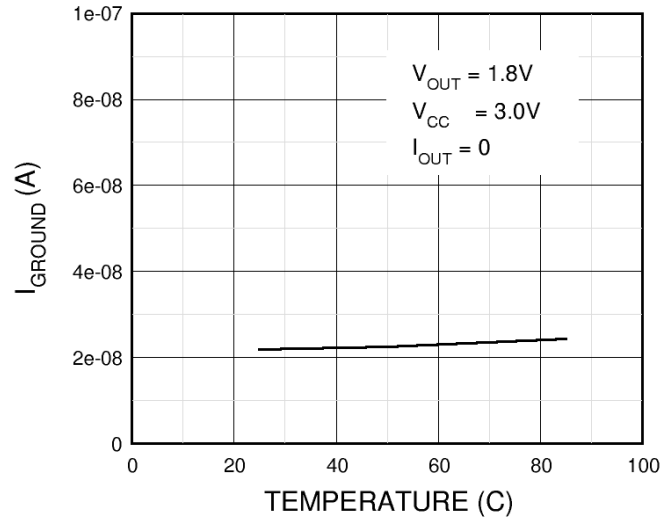

I_{qq} Performance vs. Load Current

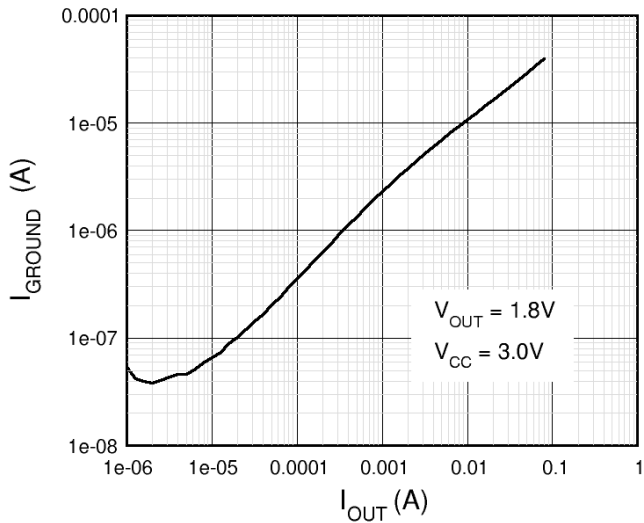

I_{qq} Performance vs. Load Current

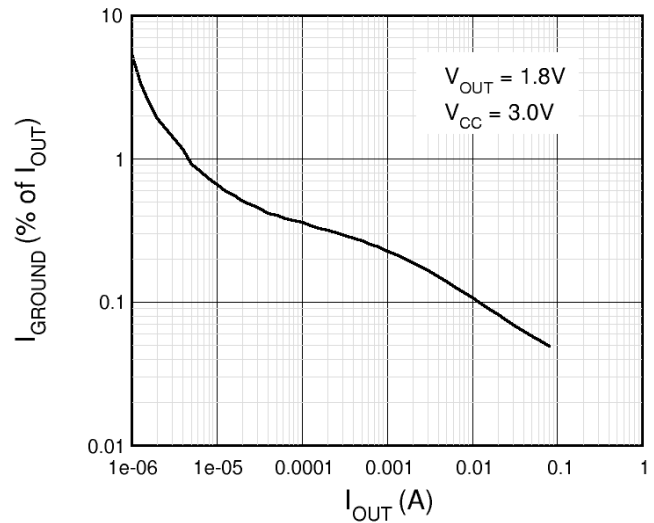

Line Regulation Performance

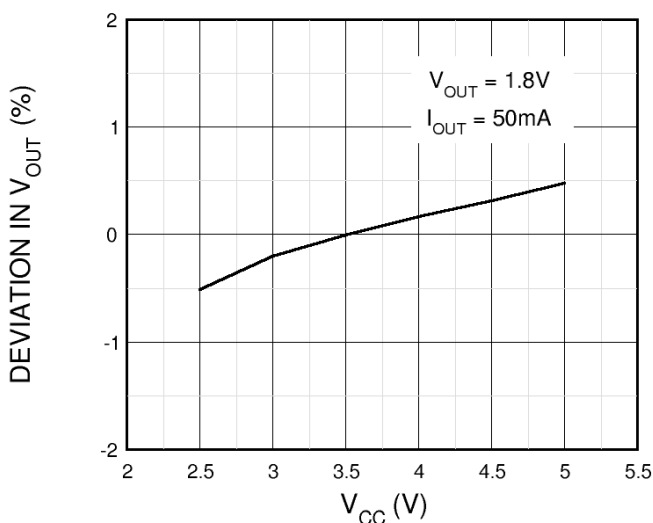

V_{OUT} Performance vs. Temperature

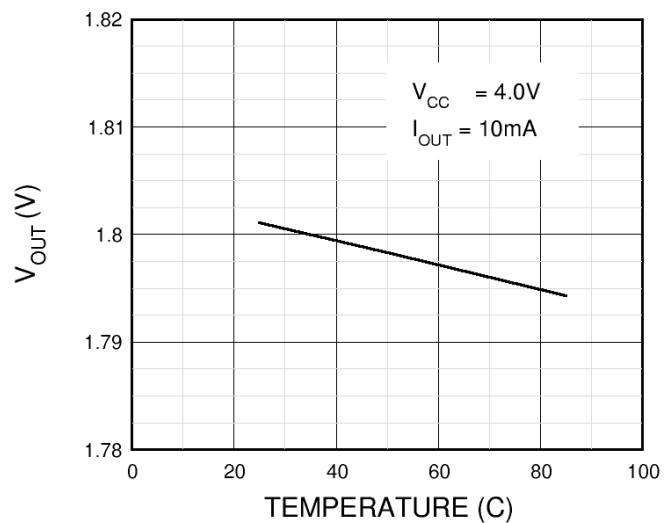

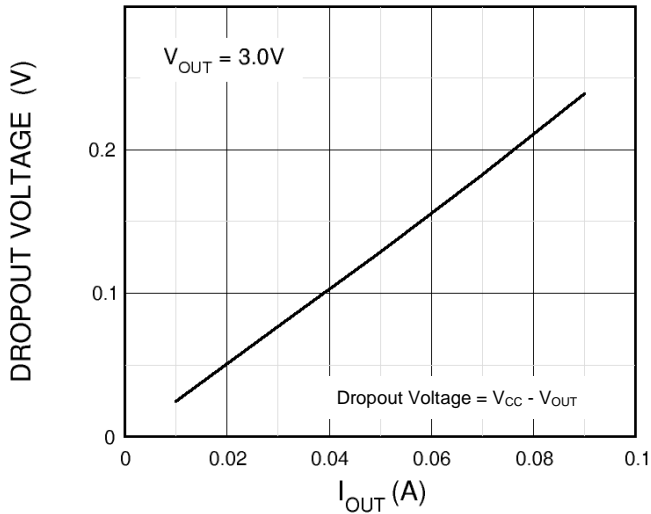
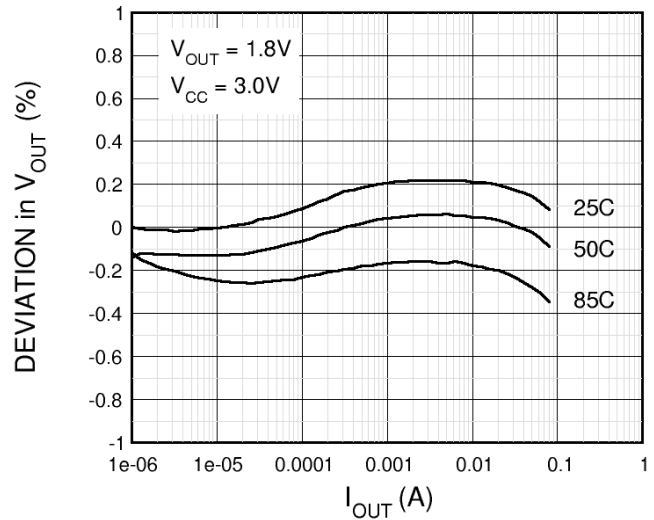
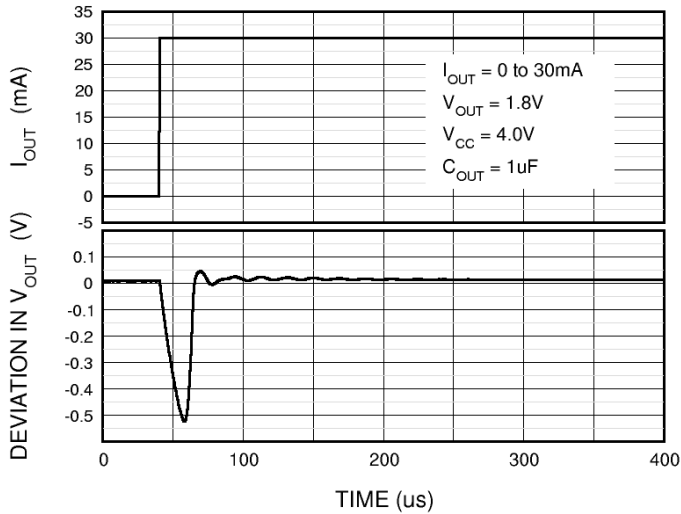
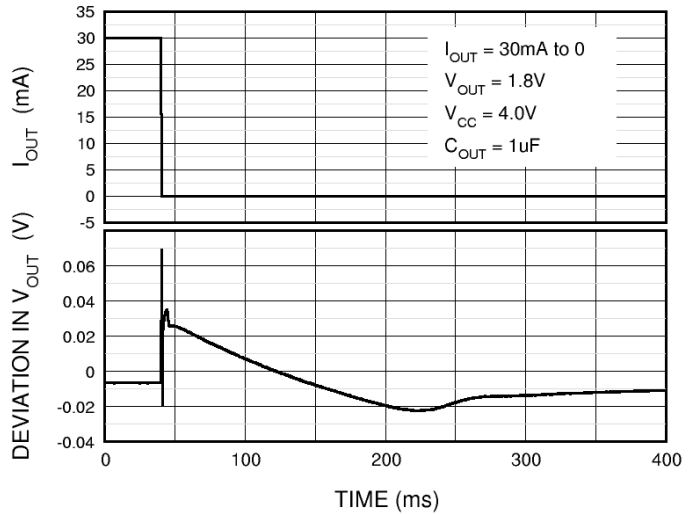
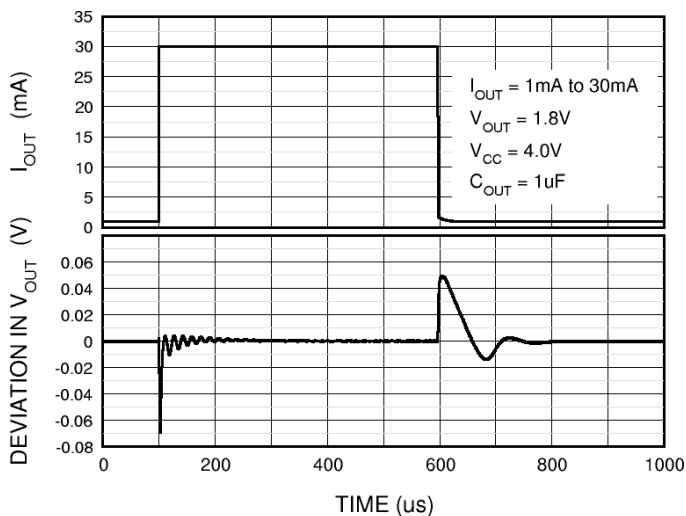
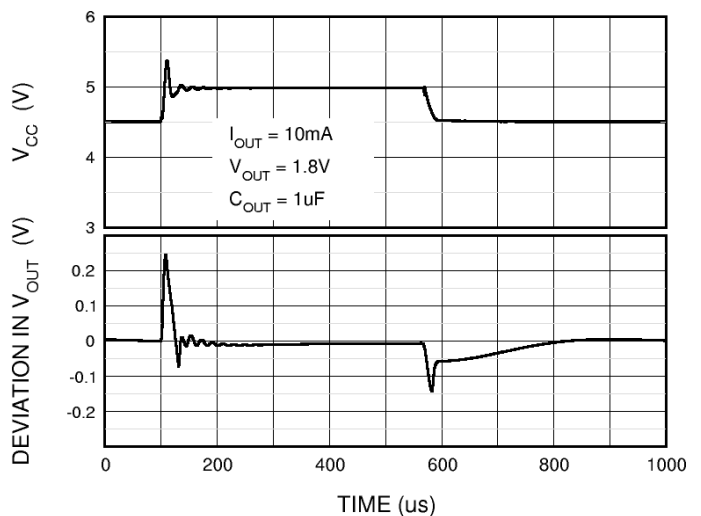
Dropout Voltage When V_{OUT} Drops By 3%

Load Regulation Performance

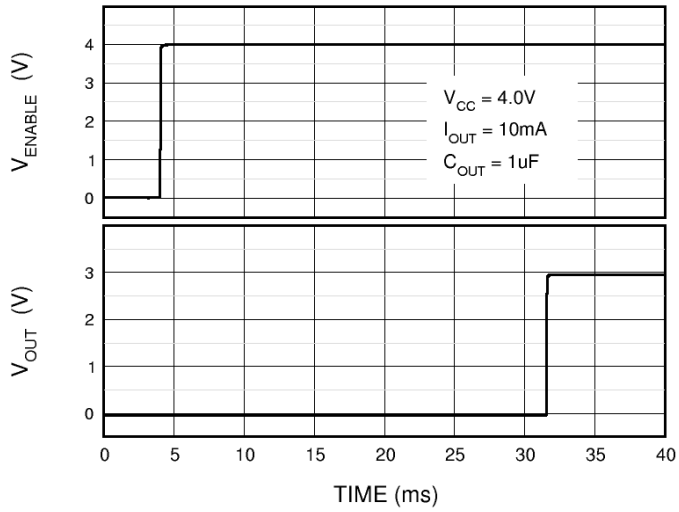
Load Step Response

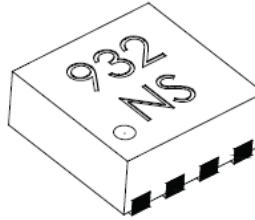
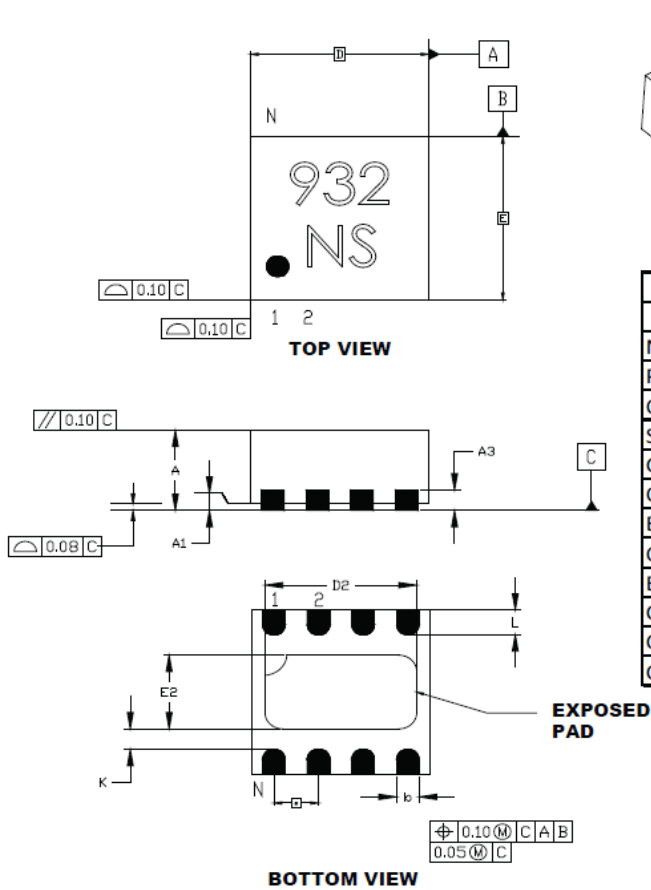
Load Step Response

Load Step Response

Line Step Response

Output Enable Timing



PACKAGE MECHANICAL DRAWINGS

Dimensions	Units	MILLIMETERS		
		MIN	NOM	MAX
Number of Pins	N	8		
Pitch	e	0.50 BSC		
Overall Height	A	0.80	0.90	1.00
Standoff	A1	0.00	0.02	0.05
Contact Thickness	A3	0.20 REF		
Overall Length	D	2.00 BSC		
Exposed Pad Width	E2	0.75	0.90	1.00
Overall Width	E	2.00 BSC		
Exposed Pad Length	D2	1.55	1.70	1.80
Contact Width	b	0.18	0.25	0.30
Contact Length	L	0.20	0.30	0.40
Contact-to-Exposed Pad	K	0.20	-	-

Notes:
 Dimensions and tolerancing per ASME Y14.5M
 BSC: Basic Dimension. Theoretically exact value shown without tolerances.
 REF: Reference Dimension, usually without tolerance, for information only.

RECOMMENDED PCB LAND PATTERN

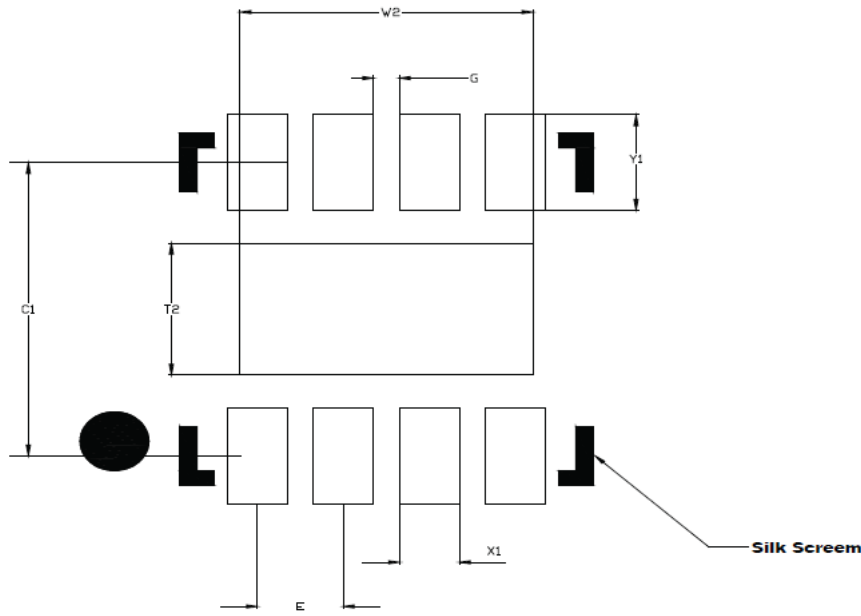

**RECOMMENDED
LAND PATTERN**

Dimension Limits	Units	MILLIMETERS		
		MIN	NOM	MAX
Contact Pitch	E	0.50 BSC		
Optional Center Pad Width	W2	-	-	1.70
Optional Center Pad Length	T2	-	-	0.90
Contact Pad Spacing	C1	-	2.00	-
Contact Pad Width (X8)	X1	-	-	0.35
Contact Pad Length (X8)	Y1	-	-	0.65
Distance Between Pads	G	0.15	-	-

APPLICATION USING A MULTI-LAYER PCB

To maximize the efficiency of this package for application on a single layer or multi-layer PCB, certain guidelines must be followed when laying out this part on the PCB.

The following are guidelines for mounting the exposed pad IC on a Multi-Layer PCB with ground a plane.

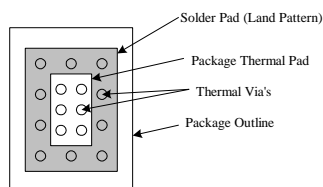

Package and PCB Land Configuration
For a Multi-Layer PCB

JEDEC standard FR4 PCB Cross-section:

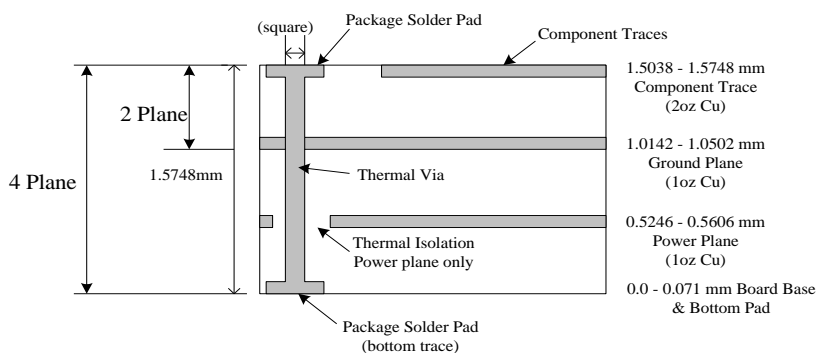

Multi-Layer Board (Cross-sectional View)

In a multi-layer board application, the thermal vias are the primary method of heat transfer from the package thermal pad to the internal ground plane. The efficiency of this method depends on several factors, including die area, number of thermal vias, thickness of copper, etc.

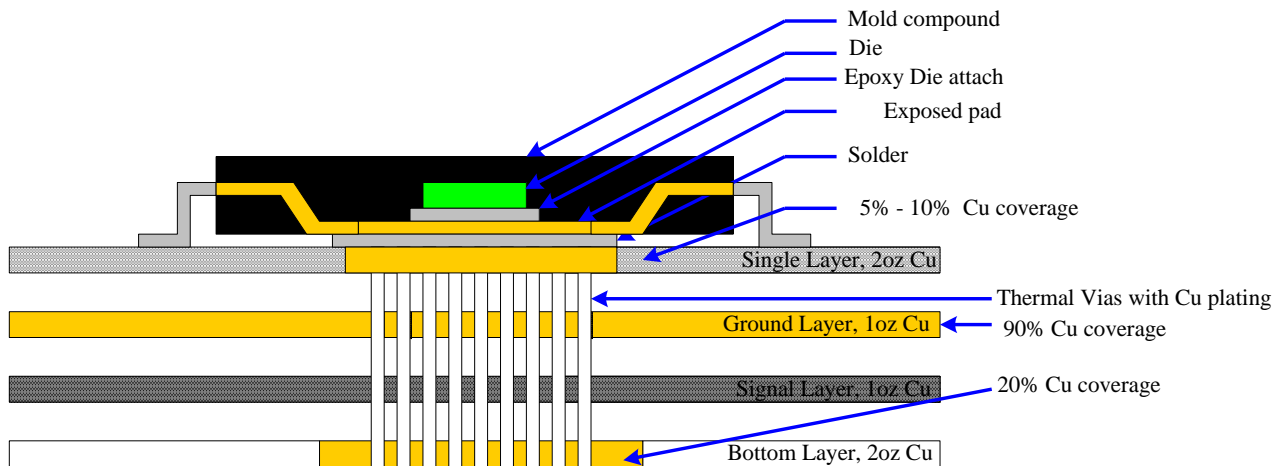

Note: NOT to Scale

The above drawing is a representation of how the heat can be conducted away from the die using an exposed pad package. Each application will have different requirements and limitations and therefore the user should use sufficient copper to dissipate the power in the system. The output current rating for the linear regulators may have to be de-rated for ambient temperatures above 85C. The de-rate value will depend on calculated worst case power dissipation and the thermal management implementation in the application.

APPLICATION USING A SINGLE LAYER PCB

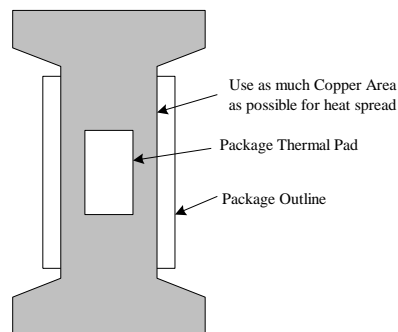

Layout recommendations for a Single Layer PCB: utilize as much Copper Area for Power Management. In a single layer board application the thermal pad is attached to a heat spreader (copper areas) by using low thermal impedance attachment method (solder paste or thermal conductive epoxy).

In both of the methods mentioned above it is advisable to use as much copper traces as possible to dissipate the heat.

IMPORTANT:

If the attachment method is NOT implemented correctly, the functionality of the product is not guaranteed. Power dissipation capability will be adversely affected if the device is incorrectly mounted onto the circuit board.

ORDERING INFORMATION**TS14001-CvvvDFNR**

vvv	Output Voltage*
012	1.2 V
018	1.8 V
025	2.5 V
033	3.3 V
042	4.2 V

* Custom values also available (1.2V - 4.2V typical in 100mV increments)

Legal Notices

Information contained in this publication regarding device applications and the like is provided only for your convenience and may be superseded by updates. It is your responsibility to ensure that your application meets with your specifications. "Typical" parameters which may be provided in Triune Systems data sheets and/or specifications can and do vary in different applications and actual performance may vary over time. All operating parameters, including "Typicals" must be validated for your application by your technical experts. TRIUNE SYSTEMS MAKES NO REPRESENTATIONS OR WARRANTIES OF ANY KIND WHETHER EXPRESS OR IMPLIED, WRITTEN OR ORAL, STATUTORY OR OTHERWISE, RELATED TO THE INFORMATION, INCLUDING BUT NOT LIMITED TO ITS CONDITION, QUALITY, PERFORMANCE, MERCHANTABILITY OR FITNESS FOR PURPOSE. Triune Systems disclaims all liability arising from this information and its use. Triune System products are not designed, intended, or authorized for use as components in systems intended for surgical implant into the body, or other applications intended to support or sustain life, or for any other application in which the failure of the Triune Systems product could create a situation where personal injury or death may occur. Should the Buyer purchase or use Triune Systems products for any such unintended or unauthorized application, the Buyer shall indemnify and hold Triune Systems, and its officers, employees, subsidiaries, affiliates, and distributors harmless against all claims, costs, damages, and expenses, and reasonable attorney fees arising out of, directly or indirectly, any claim of personal injury or death associated with such unintended or unauthorized use, even if such claim alleges that Triune Systems was negligent regarding the design or manufacture of the part. No licenses are conveyed, implicitly or otherwise, under any Triune Systems intellectual property rights.

Trademarks

The Triune Systems® name and logo, MPPT-lite™, and nanoSmart® are trademarks of Triune Systems, LLC. in the U.S.A..

All other trademarks mentioned herein are property of their respective companies.

© 2012 Triune Systems, LLC. All Rights Reserved.

Mouser Electronics

Authorized Distributor

Click to View Pricing, Inventory, Delivery & Lifecycle Information:

[Triune Systems:](#)

[TS14001-C012DFNR](#) [TS14001-C018DFNR](#) [TS14001-C025DFNR](#) [TS14001-C033DFNR](#)