

Product Overview

The TQP5525 is high power WLAN power amplifier module containing an internally matched 3-stage PA, compensated DC biasing circuit and output power detector. This PA module provides high gain (32 dB), high linearity, industry leading EVM floor, and excellent spectral purity for wideband OFDM applications. The architecture and interface are optimized for the most stringent EVM requirements of next generation 802.11.ac WLAN devices.

The TQP5525 features chipset logic compatible control voltages and buffered PA enable pin (PAEN) all of which draw very low current to facilitate ease of use and compatibility with current and future transceiver generations. With its optimized power dissipation, this amplifier module is well suited for implementation into next generation MIMO configurations and well designed to work with or without digital pre-distortion (DPD).



20 Pin 4x4 mm QFN Package

Functional Block Diagram

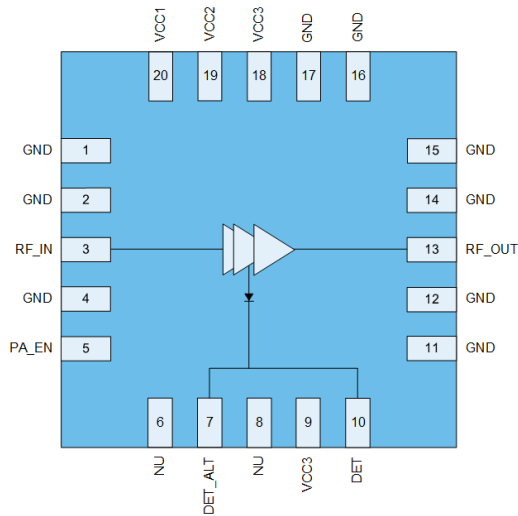

Top View

Key Features

- 4900 – 5925 MHz
- P_{OUT} = +18dBm MCS9 VHT80 -36dB Dynamic EVM
- P_{OUT} = +25dBm MCS7 HT40 -30dB Dynamic EVM
- P_{OUT} = +26.5dBm MCS0 HT20 Spectral Mask Compliance
- Optimized for +5 V Operation, 3.3 to 5V Capable
- 32 dB Tx Gain
- Integrated DC Power Detector

Applications

- Access Points
- Wireless Routers
- Residential Gateways
- Customer Premise Equipment
- Internet of Things

Ordering Information

Part Number	Description
TQP5525	13" reel with 2,500 pcs
TQP5525PCK401	Assembled Eval Board w/ 5 pcs

Absolute Maximum Ratings

Parameter	Conditions	Rating
Device Voltage	VCC1, VCC2, VCC3	Up to +6 V
Storage Temperature		-40 to 150 °C
Case Temperature	Survival	-40 to 100 °C
Junction Temperature	MTTF > 1.0x10 ⁶ hours	170 °C
RF Input Power at RFIN	Into 50 Ω Load for 802.11a-ac (No Damage), Enabled Mode	+5 dBm

Exceeding any one or a combination of the Absolute Maximum Rating conditions may cause permanent damage to the device. Extended application of Absolute Maximum Rating conditions to the device may reduce device reliability.

Recommended Operating Conditions

Parameter	Min.	Typ.	Max.	Units
Operating Frequency	4900		5925	MHz
Device Voltage (V _{CC})	+3.15	+5	+5.25	V
Control Voltage – High	+1.8	+3	V _{CC1}	V
Control Voltage - Low		0	+0.45	V
T _{OPERATING} *	-40		+85	°C

Electrical specifications are measured at specified test conditions. Specifications are not guaranteed over all recommended operating conditions. . * T_{OPERATING} is temperature at package ground.

Electrical Specifications

Parameter	Conditions	Min.	Typ.	Max.	Units
Transmit (RFIN-RFOUT) Mode	Unless otherwise noted: V_{CC1}, V_{CC2}, V_{CC3}=5V, V_{PA_EN}=3V, T=+25°C, PA_EN=High				
Wi-Fi 5 VHT80 ⁽¹⁾ Output Power	MCS9 256QAM 11ac		18		dBm
Dynamic EVM			-40	-36	dB
Wi-Fi 5 VHT80 Output Power	MCS9 256QAM 11ac		24		dBm
Dynamic EVM			-36	-31	dB
Wi-Fi 4 HT40 Output Power	MCS7 64QAM 11n		25		dBm
Dynamic EVM			-33		dB
Margin to HT20 Spectral Mask	P _{OUT} = +24 dBm, 11ac MCS0, f = 5150-5250 MHz		5		dB
	P _{OUT} = +26.5 dBm, 11ac MCS0, f = 5250-5725 MHz		5		dB
	P _{OUT} = +27.5 dBm, 11ac MCS0, f = 5725-5925 MHz		5		dB
Gain	f = 4900-5150 MHz	28	31	35	dB
	f = 5150-5925 MHz	29	32	37	
Gain Flatness	Across any 80 MHz Channel	-0.25		+0.25	dB
Out of Band Gain	f = 1716-1959 MHz			-50	dB
	f = 3433-3917 MHz			0	dB

Parameter	Conditions	Min.	Typ.	Max.	Units
RFIN Port Return Loss			10		dB
RFOUT Port Return Loss			10		dB
Quiescent Current	RF Off		350	400	mA
Operating Current	P _{OUT} = +21 dBm		475	550	mA
	P _{OUT} = +24 dBm		600	675	mA
	P _{OUT} = +27.5 dBm		750	850	mA
2 nd Harmonics	P _{OUT} = +22 dBm, 11ac VHT20 MCS0 f = 5150-5250MHz,		-45		dBm/MHz
	P _{OUT} = +26.5 dBm, 11ac VHT20 MCS0, f = 5250-5725MHz,		-45		dBm/MHz
	P _{OUT} = +27.5 dBm, 11ac VHT20 MCS0 f = 5725-5925MHz		-45		dBm/MHz
3 rd Harmonics	P _{OUT} = +22 dBm, 11ac VHT20 MCS0 f = 5150-5250MHz,		-45		dBm/MHz
	P _{OUT} = +26.5 dBm, 11ac VHT20 MCS0, f = 5250-5725MHz,		-45		dBm/MHz
	P _{OUT} = +27.5 dBm, 11ac VHT20 MCS0 f = 5725-5925MHz		-45		dBm/ MHz
DC Detector Voltage	No RF	+0.25	+0.35	+0.38	V
	P _{OUT} = +27.5 dBm	+0.80	+0.90	+1.20	V
GENERAL SPECIFICATIONS	Unless otherwise noted: V_{CC}=5V, T=+25°C				
Control Current - High	PA_EN		20	100	μA
Control Current - Low	PA_EN		8		μA
TX Output P _{1dB}	f = 4900-5150 MHz	+29.5	+30.5		dBm
	f = 5150-5925 MHz	+30	+32		dBm
P _{SAT}	f = 4900-5250 MHz		+31.5		dBm
	f = 5250-5925 MHz		+34		dBm
Switching Time	Rise/Fall		400	800	nS
PA Stability - Output VSWR	No Spurious above -50 dBc/100 kHz, P _{OUT} = 28 dBm, all phases		6:1		
Thermal Resistance, θ _{jc}	Junction to backside paddle		17		°C/W

Notes:
1. Normalized to -45dB source

Logic Truth Table

Mode	PA_EN
Disabled	Low
Enabled	High

Evaluation Board Schematic and Layout

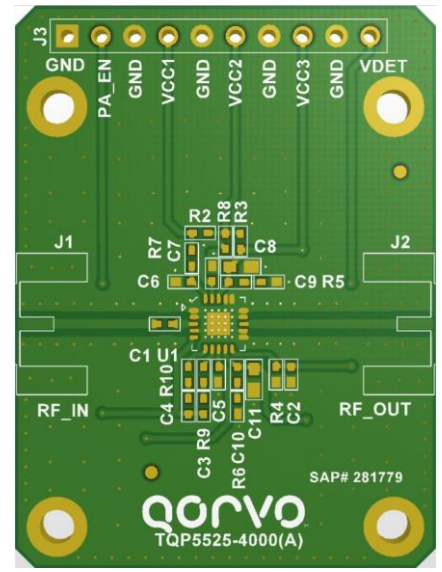
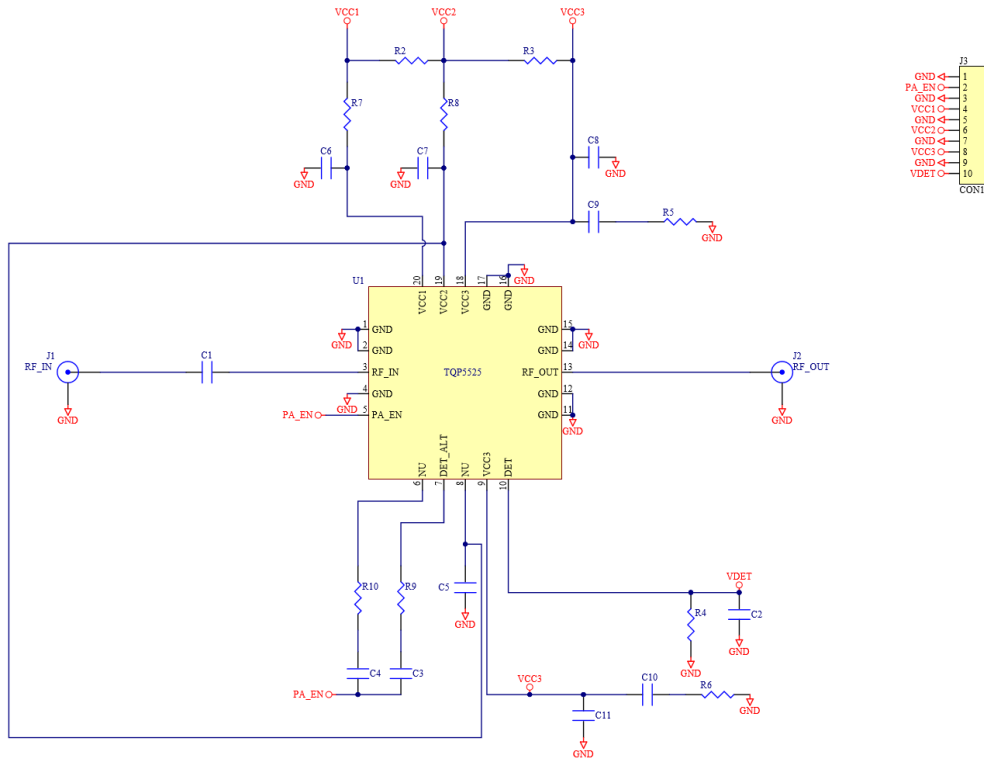

J3	1	GND
J3	2	PA_EN
J3	3	GND
J3	4	VCC1
J3	5	GND
J3	6	VCC2
J3	7	GND
J3	8	VCC3
J3	9	GND
J3	10	VDET
J3	11	CON10

Notes:

1. .

Bill of Material

Ref. Des.	Value	Description	Manuf.	Part number
-	-	Printed Circuit Board		
U1	-	5GHz Wi-Fi 5 Power Amplifier	Qorvo	TQP5525
C2, C9, C10	220 pF	Capacitor, Chip, 10%, 50V, X7R, 0402	Taiyo Yuden	RM UMK105BJ221KV-F
C6, C7	0.1 μF	Capacitor, Chip, 10%, 10V, X5R, 0402	Taiyo Yuden	RM LMK105 BJ104KV-F
C1	10 pF	Capacitor, Chip, 5%, 50V, CG, 0402	Taiyo Yuden	RM UMK105CG100JV-F
C8, C11	10 μF	Capacitor, Chip, 20%, 10V, STD, 0603	TDK	C1608X5R1A106M
R5, R6	2 Ω	Resistor, Chip,0402	Cal-Chip	RM04J2R0CT
R2, R3, R8	0 Ω	Resistor, Chip, 5%, 1/10W, 0402	Kamaya	RMC1/16SJPTH
R4	27.4 kΩ	Resistor, Chip, 1%, 1/8W, 1206	Panasonic	ERJ-8ENF2742
R7	27 Ω	Resistor, Chip, 5%, 1/16W, 0402	Panasonic	ERJ-2GEJ270
C3, C4, R9, R10	-	Do Not Install		

Performance Plots – $V_{CC} = +5\text{ V}$

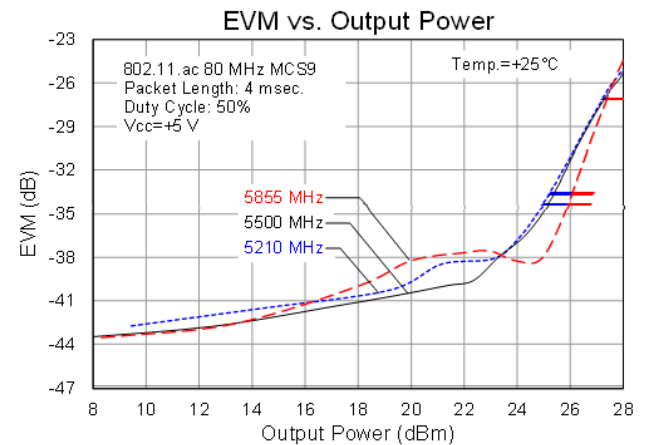
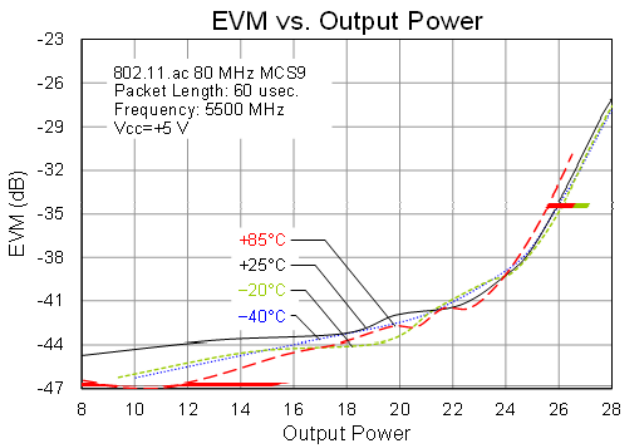
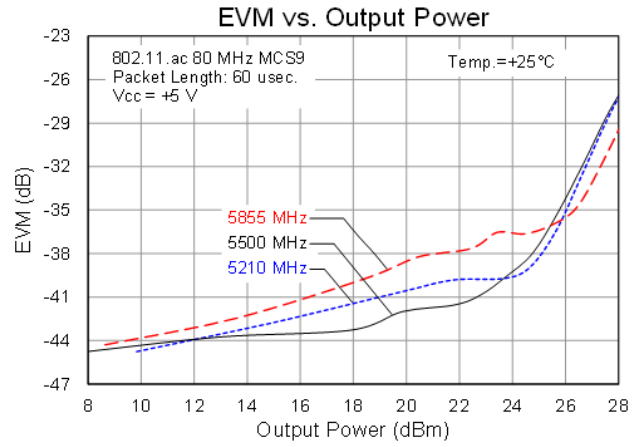
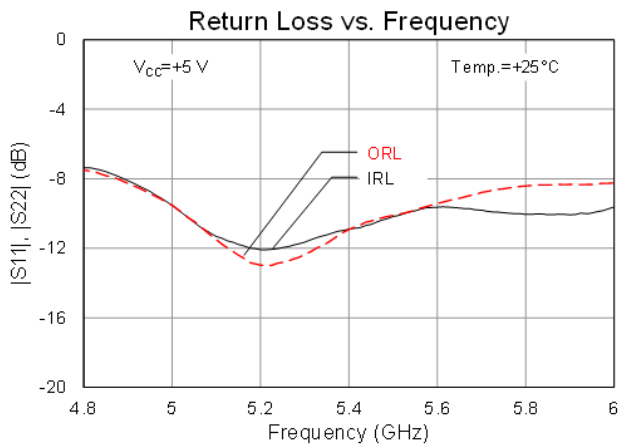
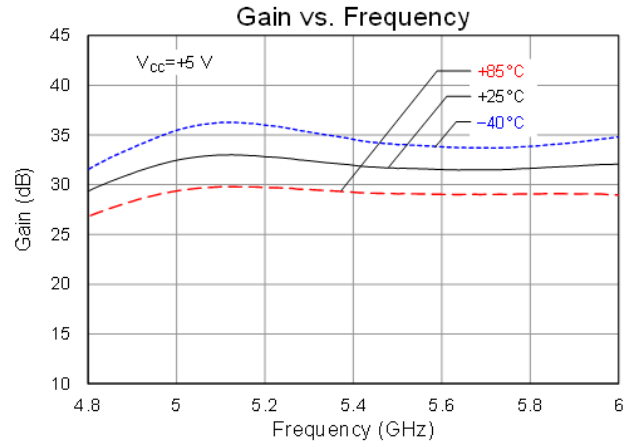
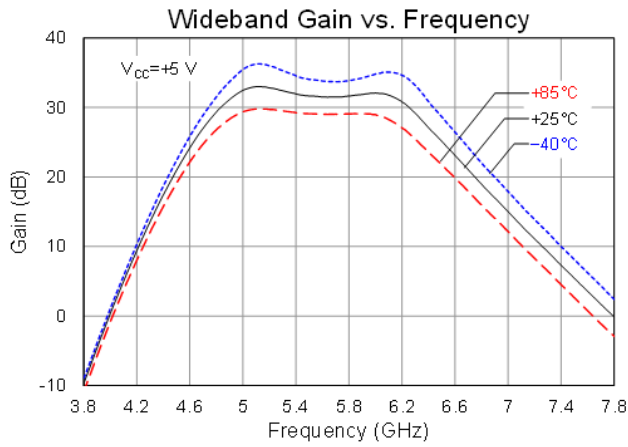

Performance Plots – $V_{CC} = +5\text{ V}$

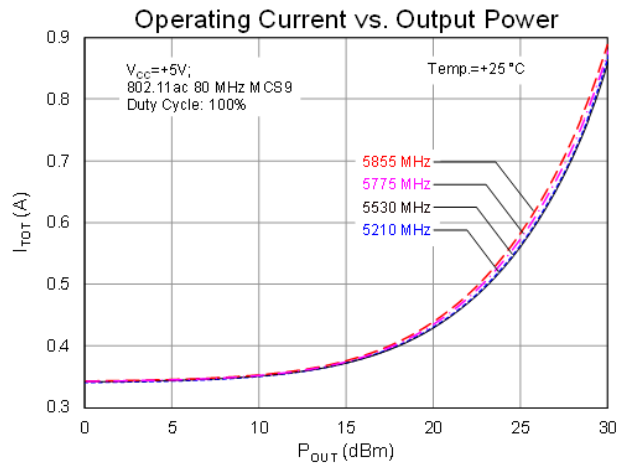
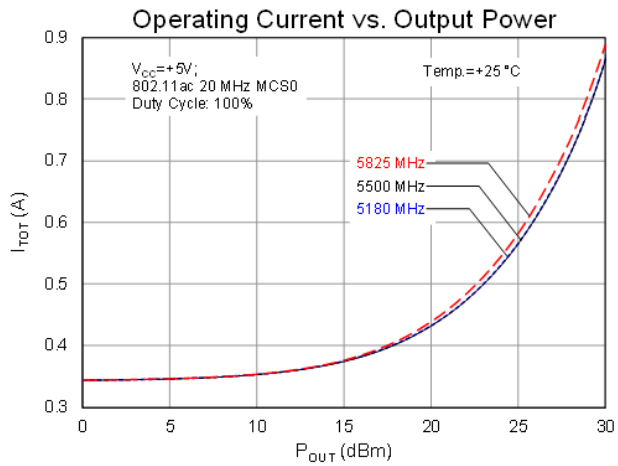
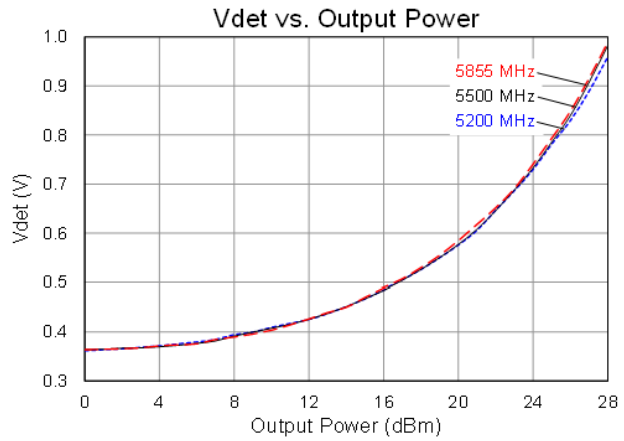
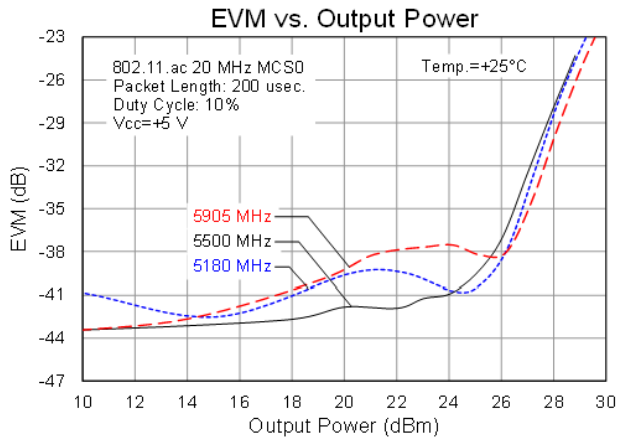

Performance Plots – $V_{CC} = +4.2\text{ V}$

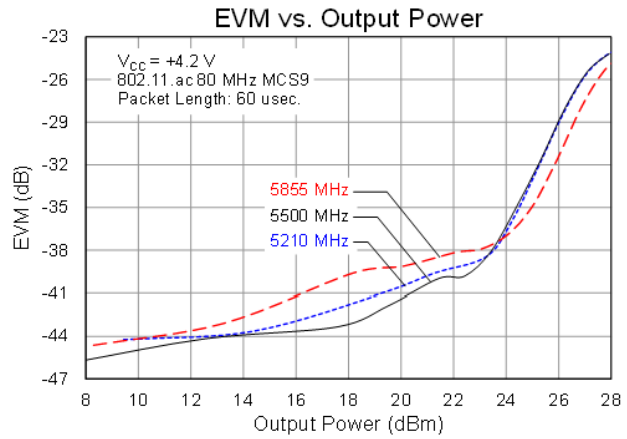
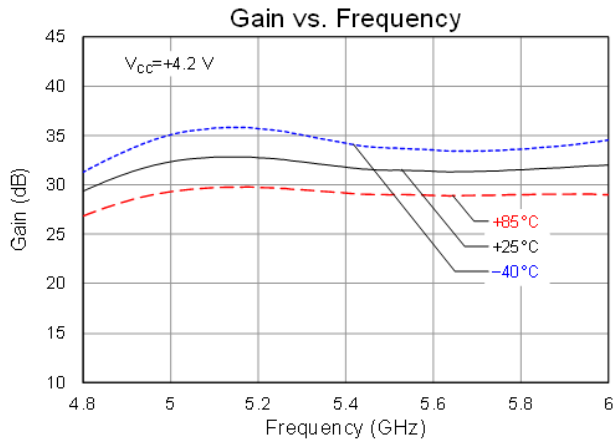

Performance Plots – $V_{CC} = +3.3\text{ V}$

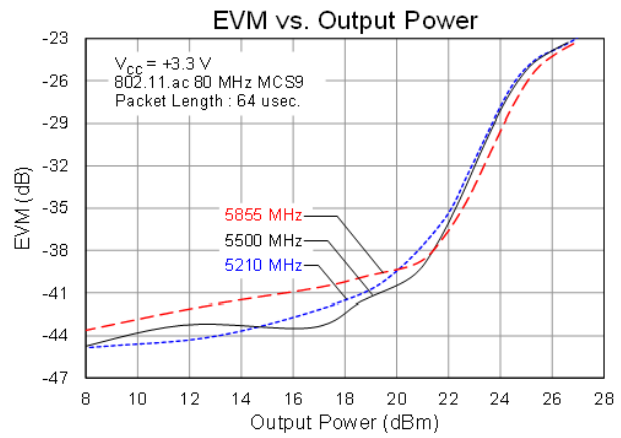
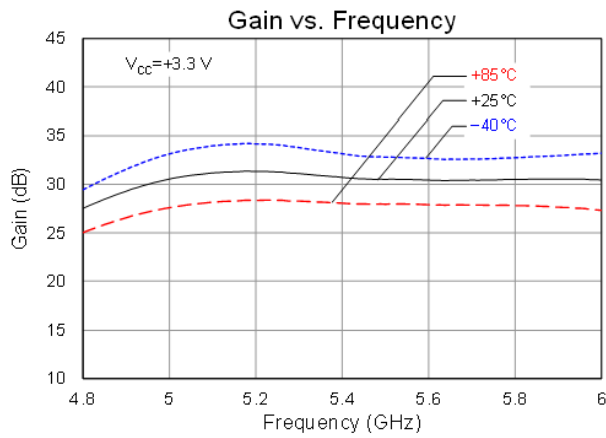

Configuration and Description

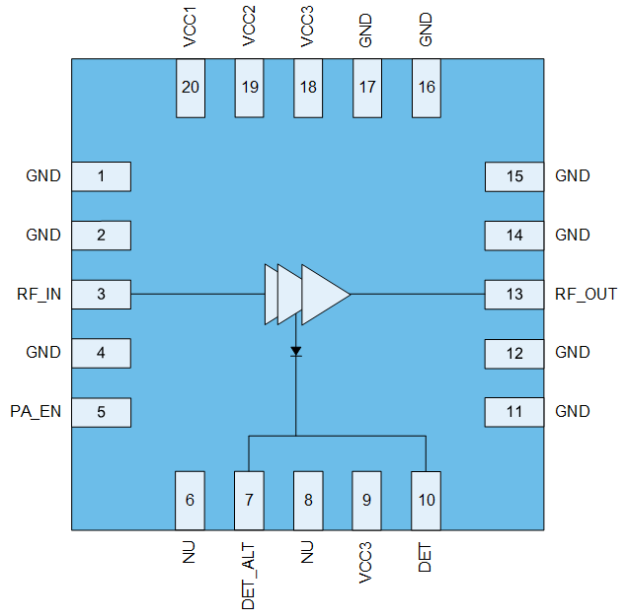

Top View

Pin Number	Label	Description
1	GND	Ground connection.
2	GND	Ground connection.
3	RF_IN	RF input. Internally matched to 50 Ω and DC shorted.
4	GND	Ground connection.
5	PA_EN	Control pin.
6	NU	No connection. Can be left floating or connected to ground
7	DET_ALT	DC power detector. Provides a voltage proportional to the RF output power level Control pin.
8	NU	No connection. Can be left floating or connected to ground
9	VCC3	Supply voltage
10	DET	DC power detector. Provides a voltage proportional to the RF output power level
11	GND	Ground connection.
12	GND	Ground connection.
13	RF_OUT	RF output. Internally matched to 50 Ω and DC blocked. ⁽¹⁾
14	GND	Ground connection.
15	GND	Ground connection.
16	GND	Ground connection.
17	GND	Ground connection.
18	VCC3	Supply voltage
19	VCC2	Supply voltage
20	VCC1	Supply voltage
Backside Paddle	GND	RF/DC ground. Use recommended via pattern to minimize inductance and thermal resistance. See PCB Mounting Pattern for suggested footprint.

Notes:



1.

Handling Precautions

Parameter	Rating	Standard
ESD – Human Body Model (HBM)	Class 1C	ESD/JEDEC JS-001-2012
ESD – Charged Device Model (CDM)	Class C3	JEDEC JESD22-C101F
MSL – Moisture Sensitivity Level	Level 1	IPC/JEDEC J-STD-020



Caution!

ESD sensitive device

Solderability

Compatible with both lead-free (260 °C max. reflow temperature) and tin/lead (245 °C max. reflow temperature) soldering processes.

Package lead plating: NiPdAu

RoHS Compliance

This part is compliant with the 2011/65/EU RoHS directive (Restrictions on the Use of Certain Hazardous Substances in Electrical and Electronic Equipment), as amended by Directive 2015/863/EU.

This product also has the following attributes:

- Lead free
- Halogen Free (Chlorine, Bromine)
- Antimony Free
- TBBP-A (C₁₅H₁₂Br₄O₂) Free
- SVHC Free



Contact Information

For the latest specifications, additional product information, worldwide sales and distribution locations:

Web: www.qorvo.com

Tel: 1-844-890-8163

Email: customer.support@qorvo.com

Important Notice

The information contained herein is believed to be reliable; however, Qorvo makes no warranties regarding the information contained herein and assumes no responsibility or liability whatsoever for the use of the information contained herein. All information contained herein is subject to change without notice. Customers should obtain and verify the latest relevant information before placing orders for Qorvo products. The information contained herein or any use of such information does not grant, explicitly or implicitly, to any party any patent rights, licenses, or any other intellectual property rights, whether with regard to such information itself or anything described by such information. **THIS INFORMATION DOES NOT CONSTITUTE A WARRANTY WITH RESPECT TO THE PRODUCTS DESCRIBED HEREIN, AND QORVO HEREBY DISCLAIMS ANY AND ALL WARRANTIES WITH RESPECT TO SUCH PRODUCTS WHETHER EXPRESS OR IMPLIED BY LAW, COURSE OF DEALING, COURSE OF PERFORMANCE, USAGE OF TRADE OR OTHERWISE, INCLUDING THE IMPLIED WARRANTIES OF MERCHANTABILITY AND FITNESS FOR A PARTICULAR PURPOSE.**

Without limiting the generality of the foregoing, Qorvo products are not warranted or authorized for use as critical components in medical, life-saving, or life-sustaining applications, or other applications where a failure would reasonably be expected to cause severe personal injury or death.

Copyright 2020 © Qorvo, Inc. | Qorvo is a registered trademark of Qorvo, Inc.

Mouser Electronics

Authorized Distributor

Click to View Pricing, Inventory, Delivery & Lifecycle Information:

Qorvo:

[TQP5525](#) [TQP5525-EVB](#)