

General Description

The Qorvo T1G4004532-FL is a 45W (P_{3dB}) discrete GaN on SiC HEMT which operates from DC to 3.5 GHz. The device is constructed with TriQuint’s proven TQGaN25 process, which features advanced field plate techniques to optimize power and efficiency at high drain bias operating conditions. This optimization can potentially lower system costs in terms of fewer amplifier line-ups and lower thermal management costs.

Lead-free and ROHS compliant

Evaluation boards are available upon request.

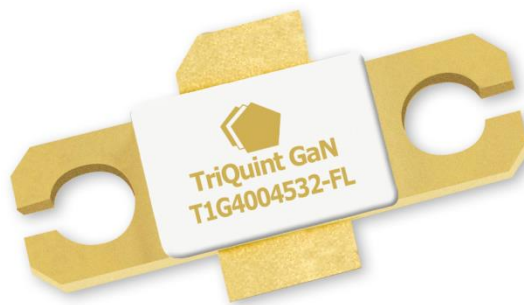

Functional Block Diagram

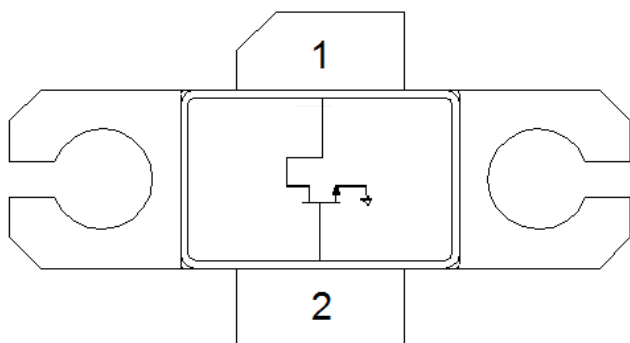

Product Features

- Frequency: DC to 3.5 GHz
 - Output Power (P_{3dB}): 78 W
 - Linear Gain¹: 20 dB
 - Typical $DEFF_{3dB}$ ¹: 73%
 - Operating Voltage: 32 V
 - Low thermal resistance package
 - CW and Pulse capable
- Note: 1 @ 3 GHz

Applications

- Military radar
- Civilian radar
- Professional and military radio communications
- Test instrumentation
- Wideband or narrowband amplifiers
- Jammers

Part No.	Description
T1G4004532-FL	DC–3.5 GHz RF Transistor
T1G4004532FLEVB01	2.7 – 3.5 GHz EVB

Absolute Maximum Ratings¹

Parameter	Rating	Units
Breakdown Voltage, BV_D	+100	V
Gate Voltage Range, V_G	-7 to +2	V
Drain Current, $I_{D_{MAX}}$	14.5	A
Gate Current Range, I_G	See page 4.	mA
Power Dissipation, CW, P_{DISS} , Base Temperature = 85 °C	61	W
RF Input Power, CW, 50 Ω , T = 25 °C	+41	dBm
Mounting Temperature (30 Seconds)	320	°C
Storage Temperature	-40 to +150	°C

Notes:

1. . Operation of this device outside the parameter ranges given above may cause permanent damage.

Recommended Operating Conditions¹

Parameter	Min	Typ	Max	Units
Operating Temperature Range	-40	+25	+85	°C
Drain Voltage Range, V_D	+12	+32	+40	V
Drain Current, I_D^3	–	2.5	–	A
Drain Bias Current, I_{DQ}	–	220	–	mA
Gate Voltage, V_G^4	–	-2.9	–	V
Power Dissipation, CW (P_D) ²	–	–	44	W
Power Dissipation, Pulsed (P_D) ^{2, 3}	–	–	68	W

Notes:

1. Electrical performance is measured under conditions noted in the electrical specifications table. Specifications are not guaranteed over all recommended operating conditions.
2. Package at 85 °C.
3. Drain current at P3dB, Pulse Width = 100 μ S, Duty Cycle = 20%.
4. To be adjusted for desired I_{DQ}

Pulsed Characterization – Load-Pull Performance – Power Tuned¹

Parameters	Typical Values				Unit
	1	2	3	3.5	
Frequency, F	1	2	3	3.5	GHz
Linear Gain, G_{LIN}	21.2	15.5	17.5	17.8	dB
Output Power at 3dB compression point, P_{3dB}	48.0	49.0	48.9	48.9	dBm
Drain Efficiency at 3dB compression point, $DEFF_{3dB}$	65.5	56.9	61.0	56.6	%
Gain at 3dB compression point	18.2	12.4	14.5	14.8	dB

Notes:

1. Test conditions unless otherwise noted: $V_D = +32\text{ V}$, $I_D = 220\text{ mA}$, $Temp = +25\text{ }^\circ\text{C}$

Pulsed Characterization – Load-Pull Performance – Efficiency Tuned¹

Parameters	Typical Values				Unit
	1	2	3	3.5	
Frequency	1	2	3	3.5	GHz
Linear Gain, G_{LIN}	20.8	16.2	20.9	17.7	dB
Output Power at 3dB compression point, P_{3dB}	44.7	47.1	45.8	47.8	dBm
Drain Efficiency at 3dB compression point, $DEFF_{3dB}$	76.8	72.7	72.9	67.1	%
Gain at 3dB compression point, G_{3dB}	17.8	13.2	17.9	14.7	dB

Notes:

1. Test conditions unless otherwise noted: $V_D = +32\text{ V}$, $I_{DQ} = 220\text{ mA}$, $Temp = +25\text{ }^\circ\text{C}$

RF Characterization – EVB1 Performance at 3.3 GHz¹

Parameter	Min	Typ	Max	Units
Linear Gain, G_{LIN}	–	19.5	–	dB
Output Power at 3dB compression point, P_{3dB}	–	44.0	–	W
Drain Efficiency at 3dB compression point, $DEFF_{3dB}$	–	52.0	–	%
Gain at 3dB compression point, G_{3dB}	–	16.5	–	dB

Notes:

1. $V_D = +50\text{ V}$, $I_{DQ} = 220\text{ mA}$, $Temp = +25\text{ }^\circ\text{C}$, Pulse Width = 100 μs , Duty Cycle = 20%

RF Characterization – Mismatch Ruggedness at 3.5 GHz

Symbol	Parameter	dB Compression	Typical
VSWR	Impedance Mismatch Ruggedness	3	10:1

Test conditions unless otherwise noted: $T_A = 25\text{ }^\circ\text{C}$, $V_D = 32\text{ V}$, $I_{DQ} = 220\text{ mA}$

Driving input power is determined at pulsed 3dB compression under matched condition at EVB output connector.

Maximum Gate Current

Maximum Gate Current Vs. Peak IR Surface Temperature

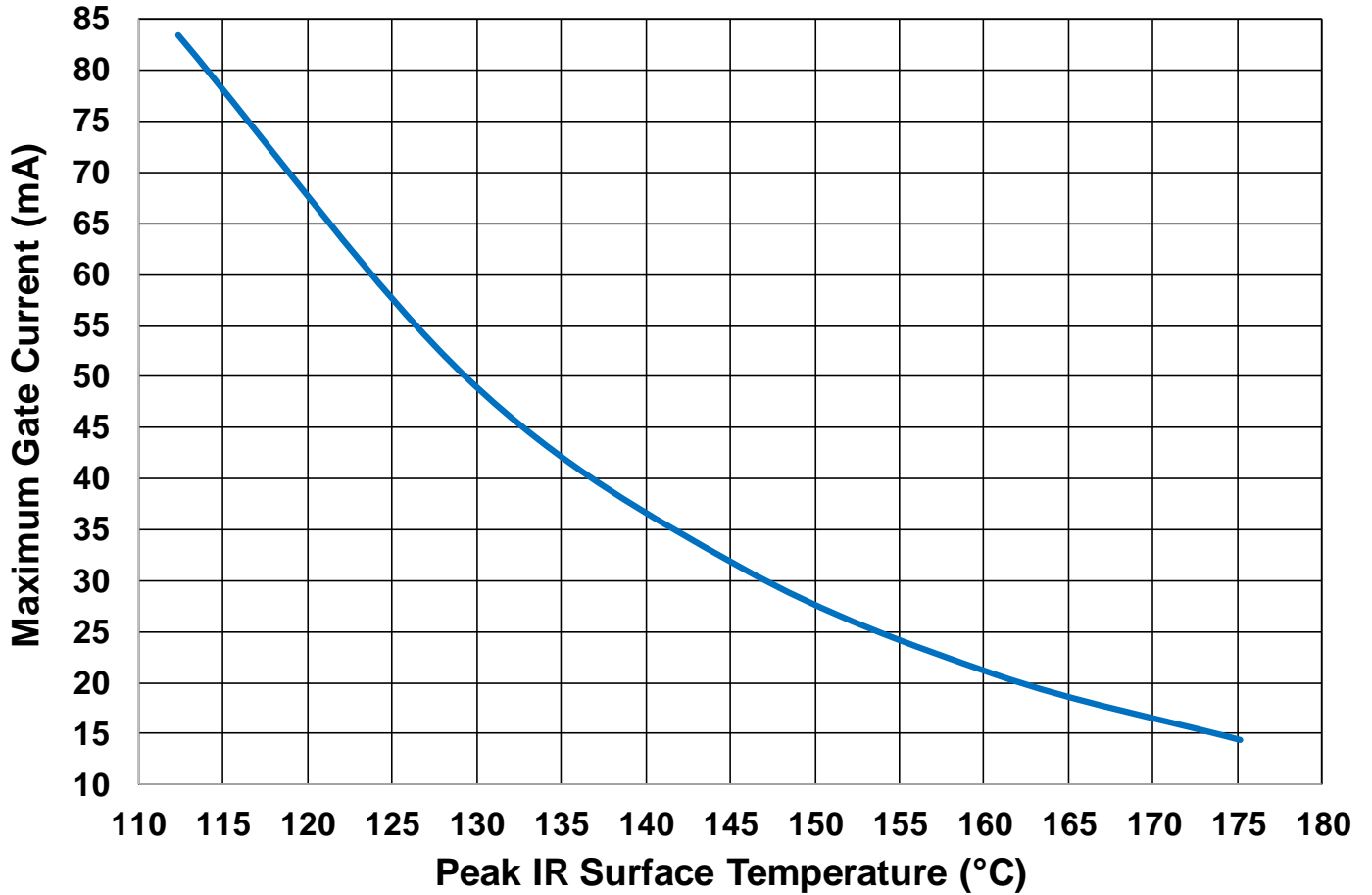

Thermal and Reliability Information – Pulsed

Peak IR Surface Temperature vs. Pulse Width

Base Fixed at 85 °C, P_{diss} = 59.2 W

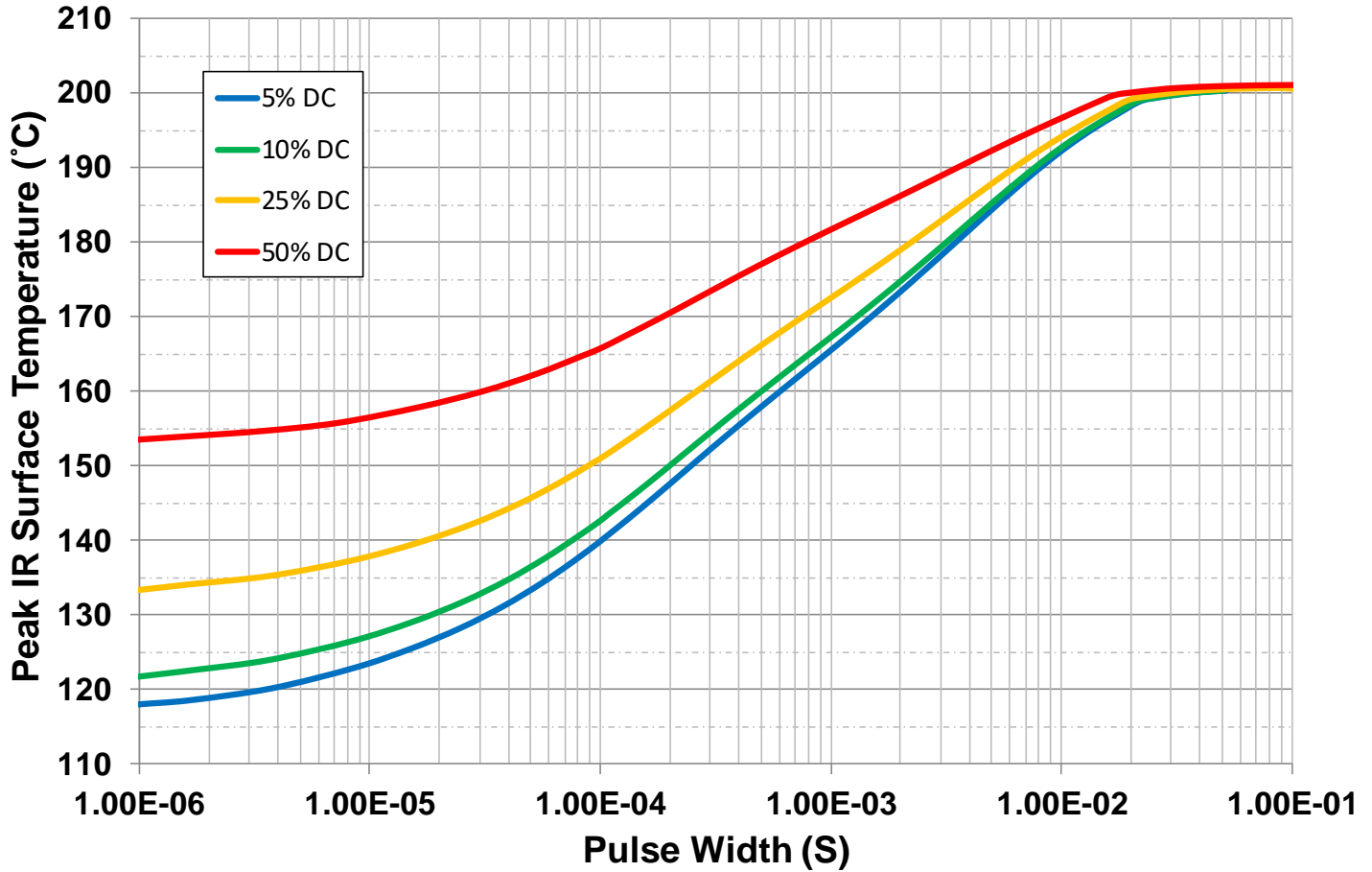

Parameter	Conditions	Values	Units
Thermal Resistance, IR ¹ (θ_{JC})	85 °C Case	0.93	°C/W
Peak IR Surface Temperature ¹ (T_{CH})	59.2 W P _{diss} , 100 uS PW, 5% DC	140	°C
Thermal Resistance, IR ¹ (θ_{JC})	85 °C Case	0.98	°C/W
Peak IR Surface Temperature ¹ (T_{CH})	59.2 W P _{diss} , 100 uS PW, 10% DC	143	°C
Thermal Resistance, IR ¹ (θ_{JC})	85 °C Case	1.11	°C/W
Peak IR Surface Temperature ¹ (T_{CH})	59.2 W P _{diss} , 100 uS PW, 25% DC	151	°C
Thermal Resistance, IR ¹ (θ_{JC})	85 °C Case	1.37	°C/W
Peak IR Surface Temperature ¹ (T_{CH})	59.2 W P _{diss} , 100 uS PW, 50% DC	166	°C

¹Refer to the following document [GaN Device Channel Temperature, Thermal Resistance, and Reliability Estimates](#)

Thermal and Reliability Information – CW

**Peak IR Surface Temperature vs. Dissipation Power
 Base Fixed at 85 °C**

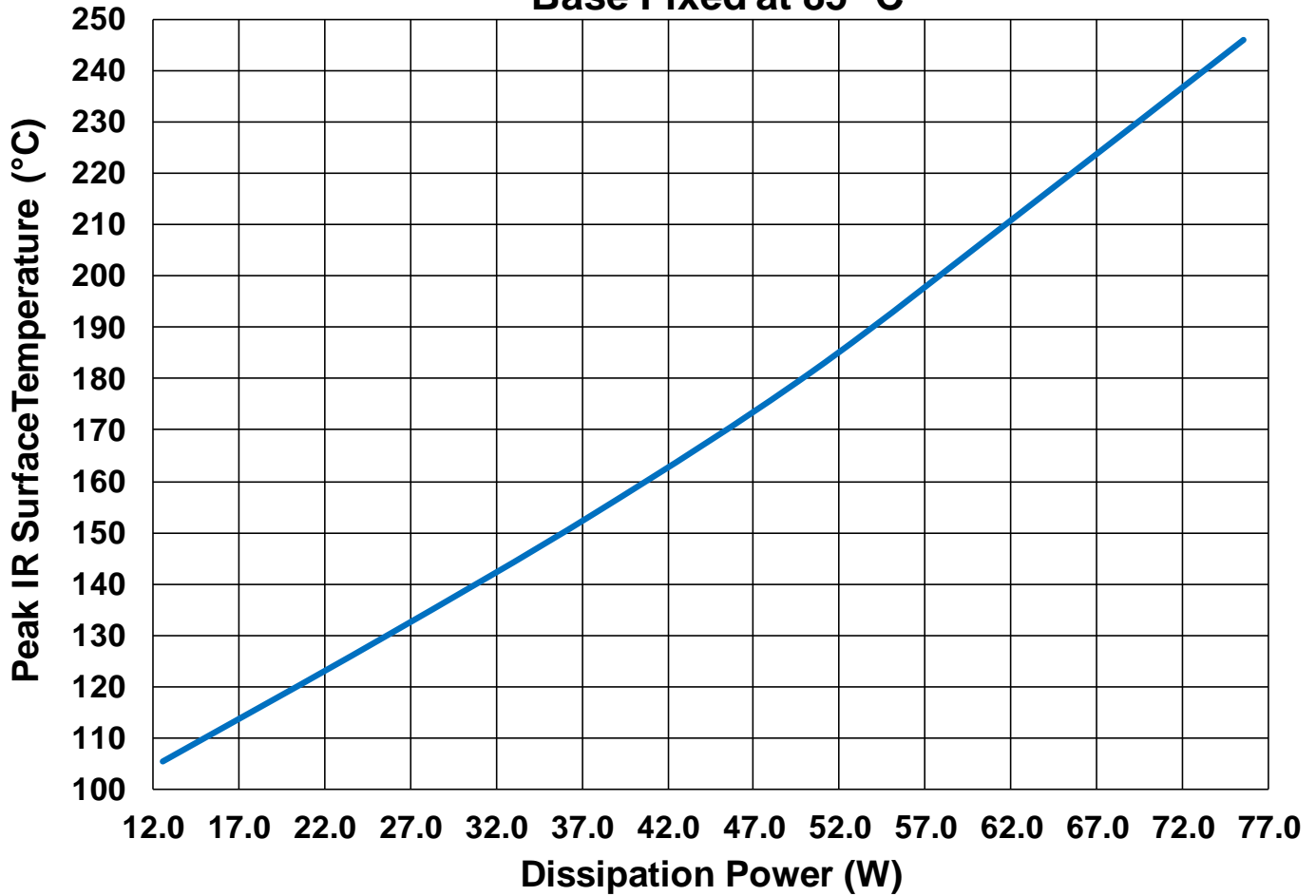

Parameter	Conditions	Values	Units
Thermal Resistance, IR ¹ (θ_{JC})	85 °C Case	1.59	°C/W
Peak IR Surface Temperature ¹ (T_{CH})	12.6 W Pdiss, CW	105	°C
Thermal Resistance, IR ¹ (θ_{JC})	85 °C Case	1.75	°C/W
Peak IR Surface Temperature ¹ (T_{CH})	25.2 W Pdiss, CW	129	°C
Thermal Resistance, IR ¹ (θ_{JC})	85 °C Case	1.83	°C/W
Peak IR Surface Temperature ¹ (T_{CH})	37.8 W Pdiss, CW	154	°C
Thermal Resistance, IR ¹ (θ_{JC})	85 °C Case	1.90	°C/W
Peak IR Surface Temperature ¹ (T_{CH})	50.4 W Pdiss, CW	181	°C
Thermal Resistance, IR ¹ (θ_{JC})	85 °C Case	2.03	°C/W
Peak IR Surface Temperature ¹ (T_{CH})	63 W Pdiss, CW	213	°C

¹Refer to the following document [GaN Device Channel Temperature, Thermal Resistance, and Reliability Estimates](#)

Load-Pull Smith Charts^{1,2}

Notes:

1. 50 V, 260 mA, Pulsed signal with 128 uS pulse width and 10 % duty cycle.
2. See page 15 for load-pull and source-pull reference planes.

1GHz, Load-pull

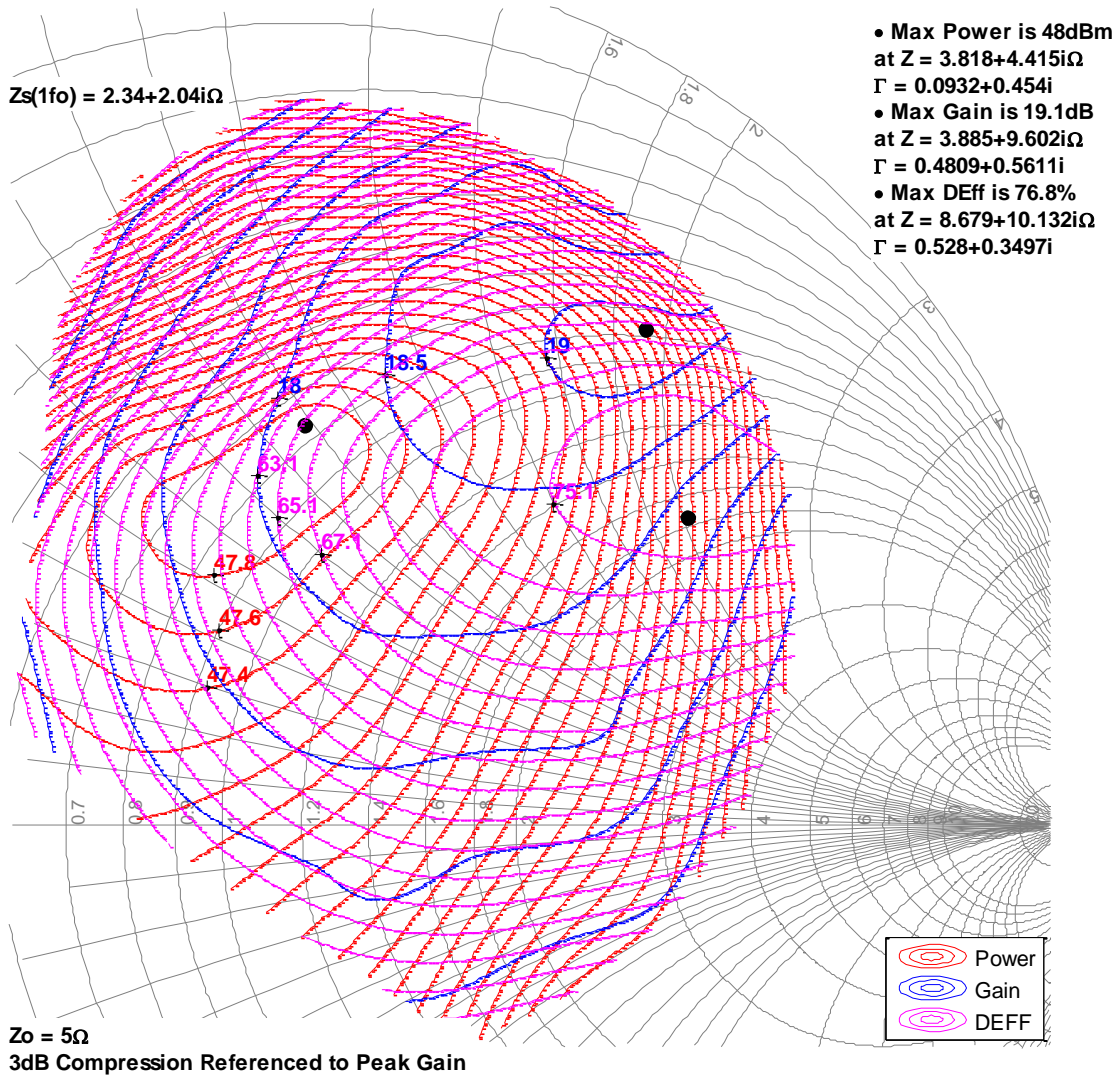

Load-Pull Smith Charts^{1, 2, 3}

Notes:

1. 32 V, 220 mA, Pulsed signal with 100 uS pulse width and 20 % duty cycle.
2. See page 15 for load-pull and source-pull reference planes.

2GHz, Load-pull

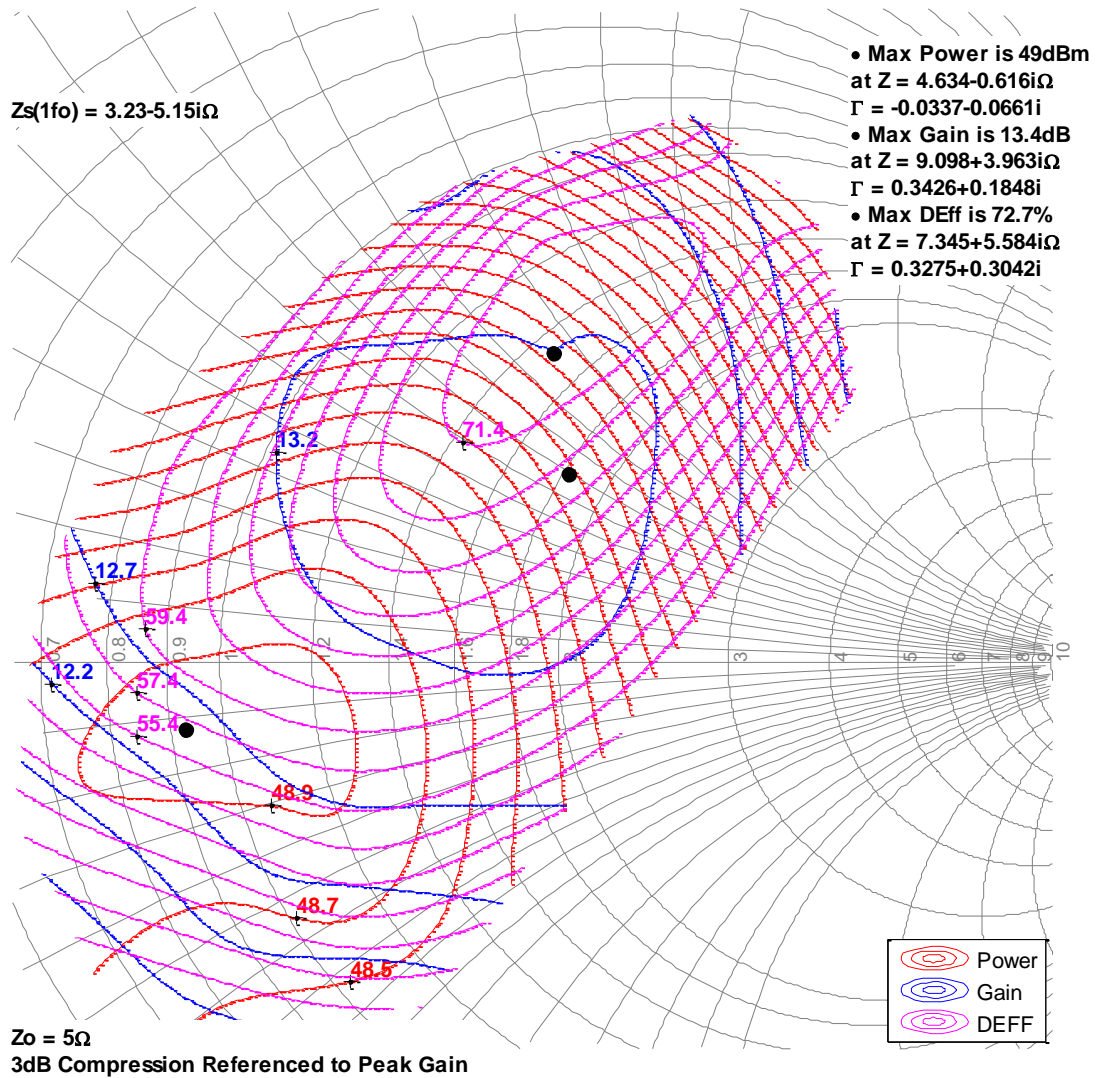

Load-Pull Smith Charts^{1, 2, 3}

Notes:

- 3. 32 V, 220 mA, Pulsed signal with 100 uS pulse width and 20 % duty cycle.
- 4. See page 15 for load-pull and source-pull reference planes.

3GHz, Load-pull

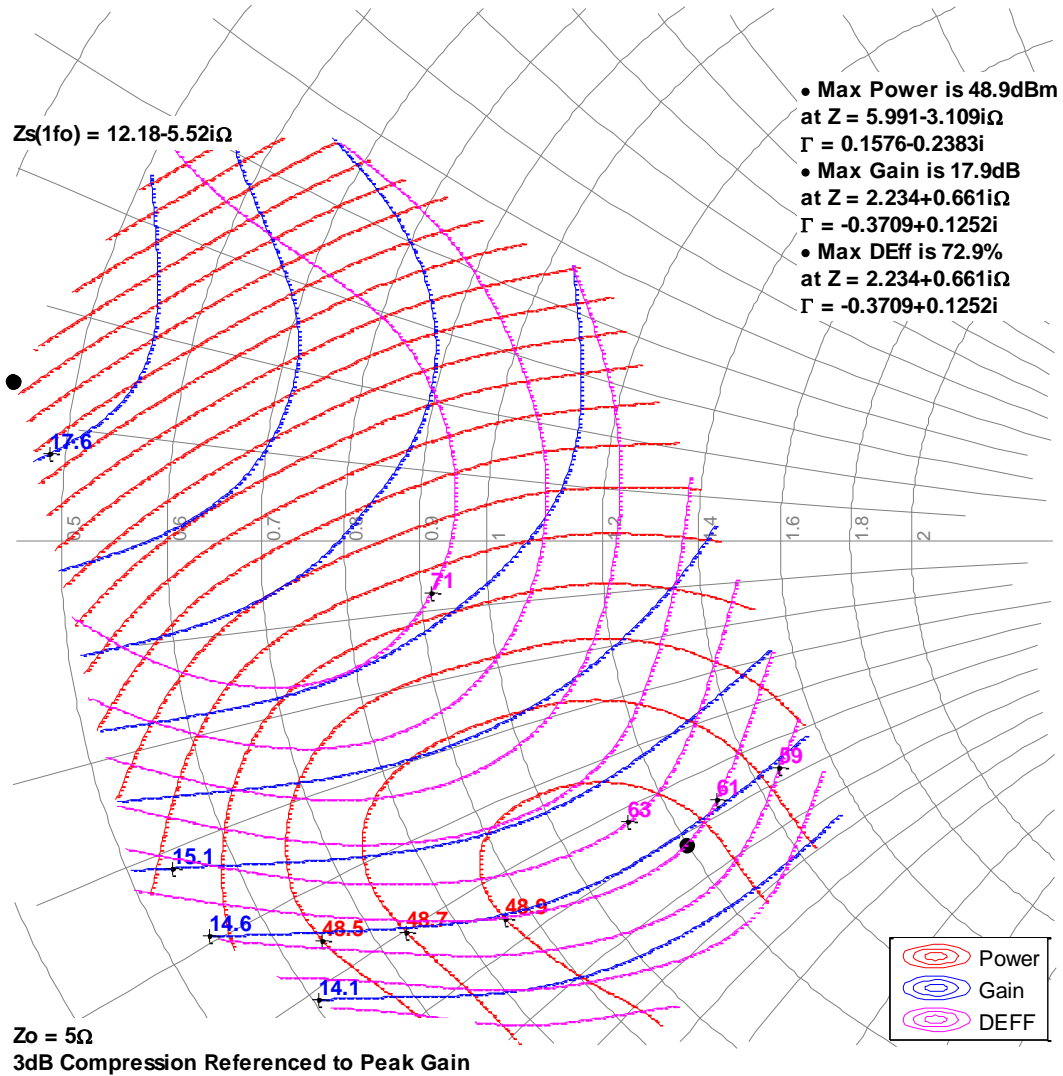

Load-Pull Smith Charts^{1, 2, 3}

Notes:

1. 50 V, 260 mA, Pulsed signal with 100 uS pulse width and 20 % duty cycle.
2. See page 15 for load-pull and source-pull reference planes.

3.5GHz, Load-pull

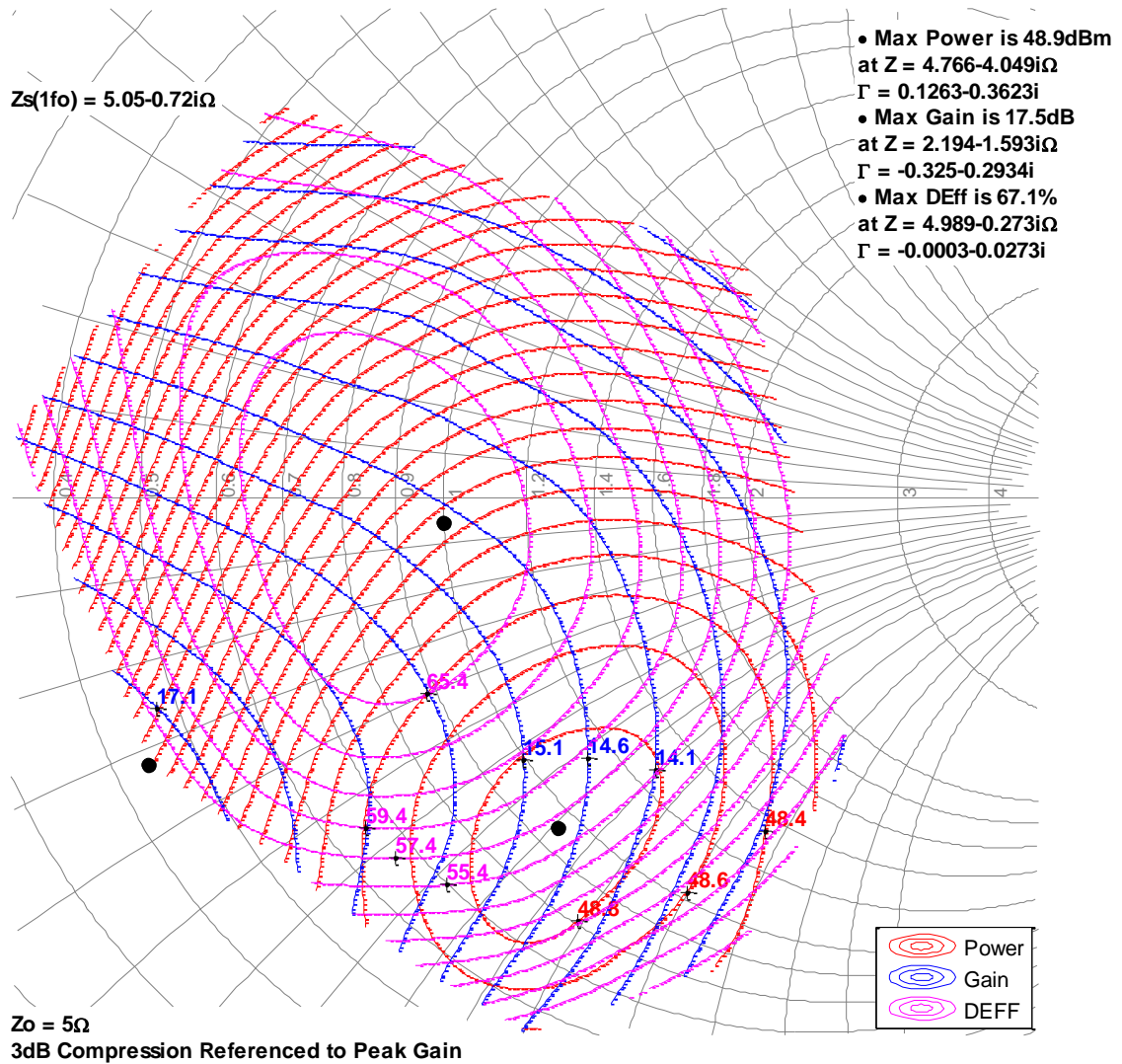

Typical Performance – Load-Pull Drive-up

Notes:

1. Pulsed signal with 100 uS pulse width and 10 % duty cycle, $V_d = 32\text{ V}$, $I_{DQ} = 220\text{ mA}$.
2. See page 15 for load-pull and source-pull reference planes where the performance was measured.

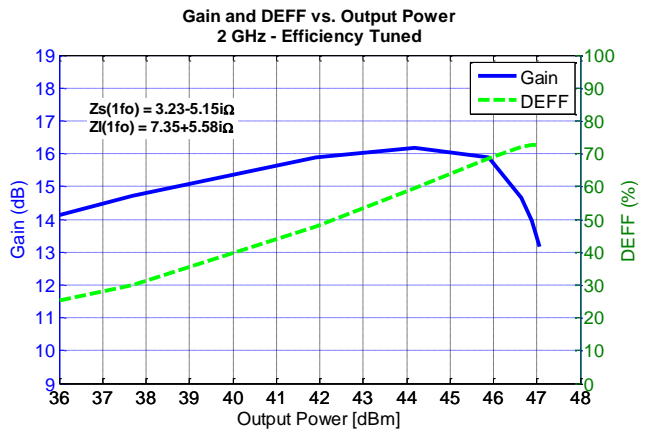
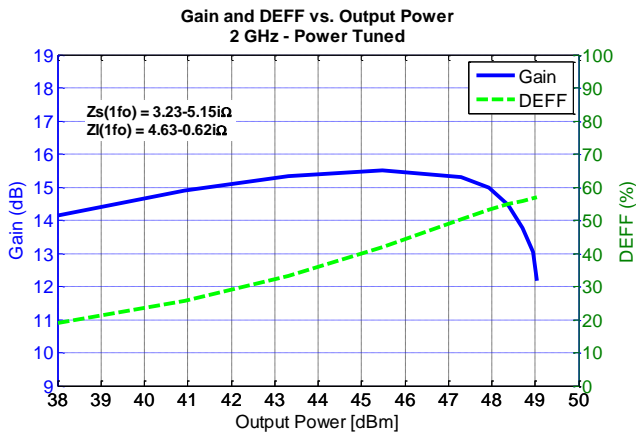
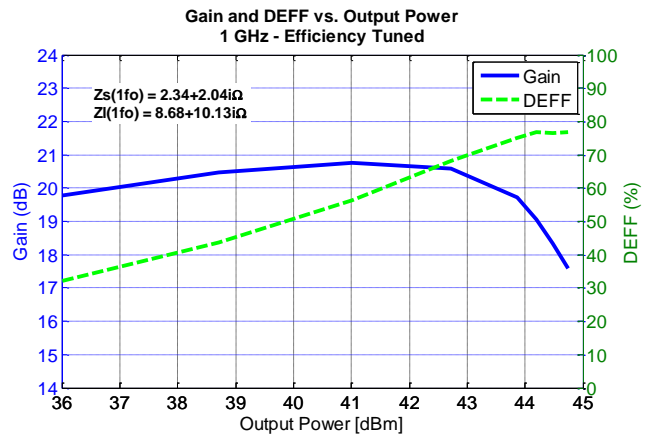
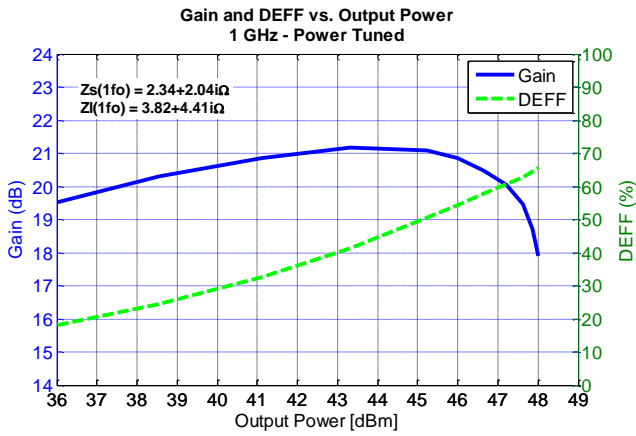

Typical Performance – Load-Pull Drive-up

Notes:

- Pulsed signal with 100 uS pulse width and 10 % duty cycle, $V_d = 32\text{ V}$, $I_{DQ} = 220\text{ mA}$.
- See page 15 for load-pull and source-pull reference planes where the performance was measured.

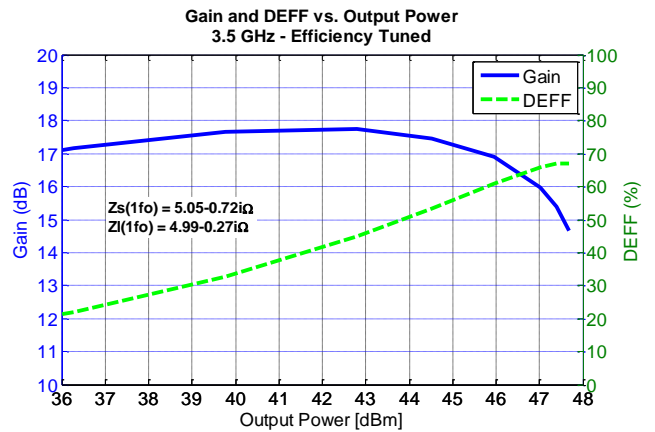
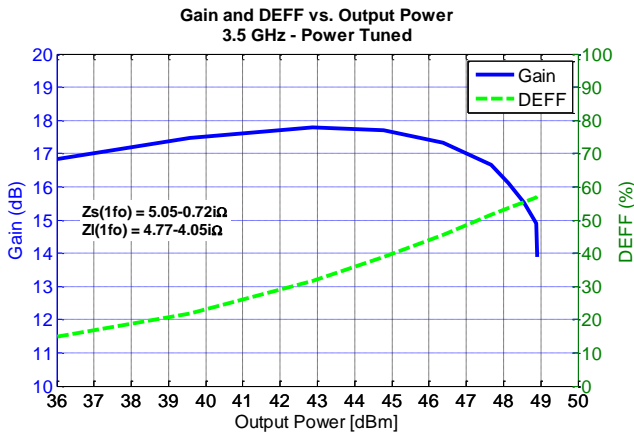
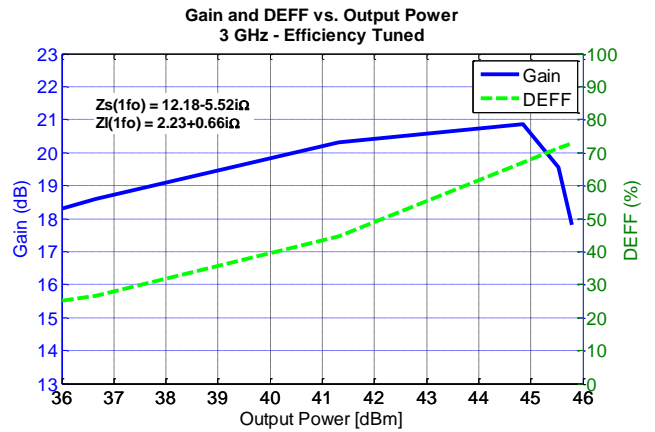
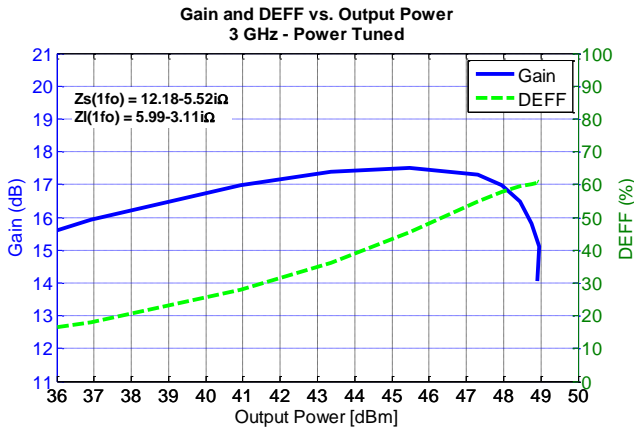

Power Driveup Performance Over Temperatures Of 2.7 – 3.5 GHz EVB¹

Notes:

1. Pulsed signal with 100 uS pulse width and 20 % duty cycle, $V_d = 32\text{ V}$, $I_{DQ} = 220\text{ mA}$.

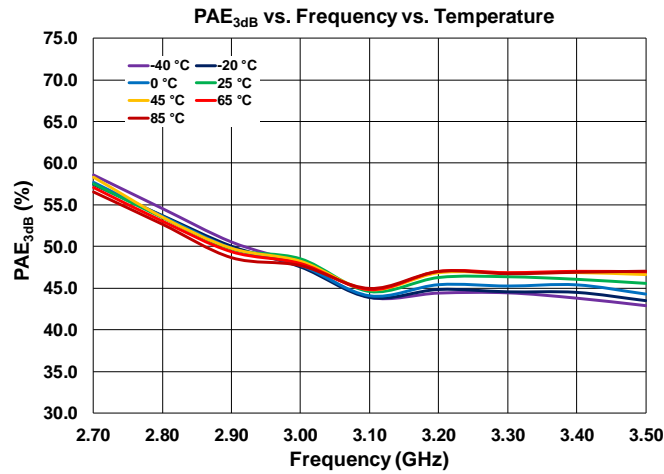
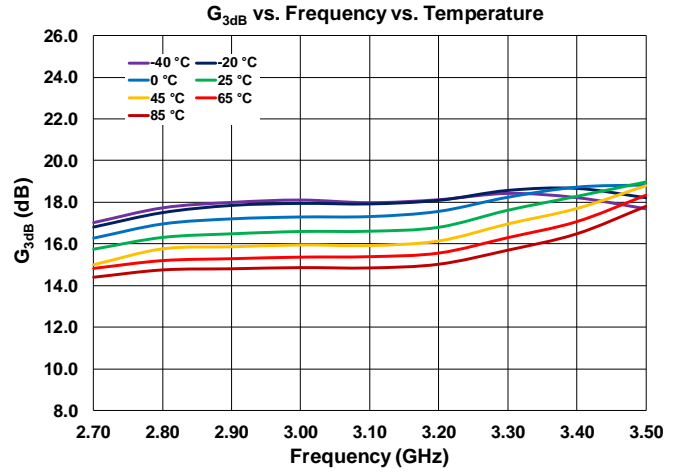
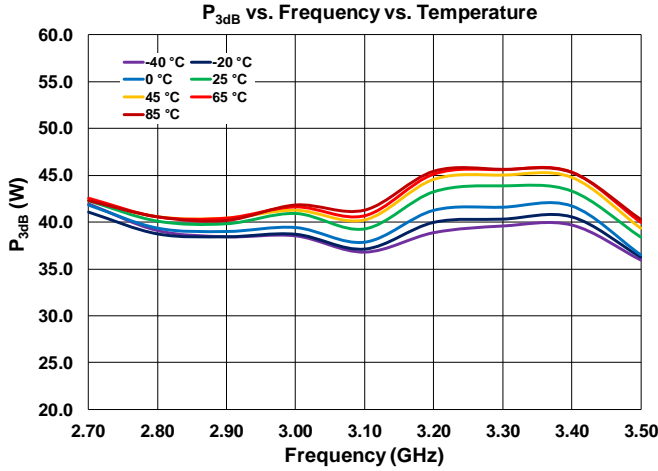

Typical Performance – 2.7 – 3.5 GHz EVB at 25 °C ¹

Notes:

1. Pulsed signal with 100 uS pulse width and 20 % duty cycle, $V_d = 32\text{ V}$, $I_{b0} = 220\text{ mA}$

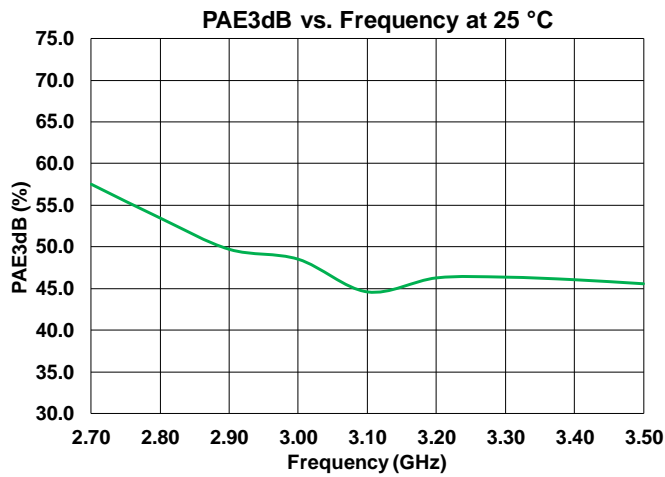
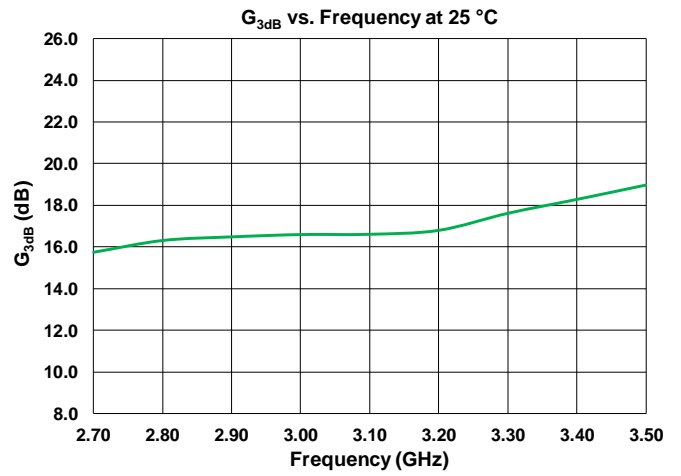
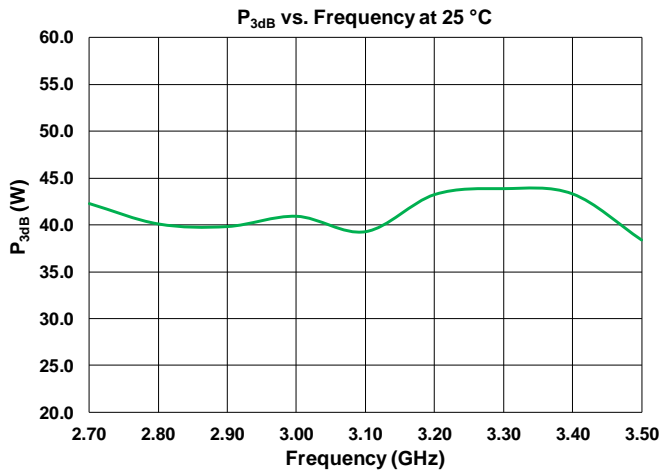

Pin Layout¹

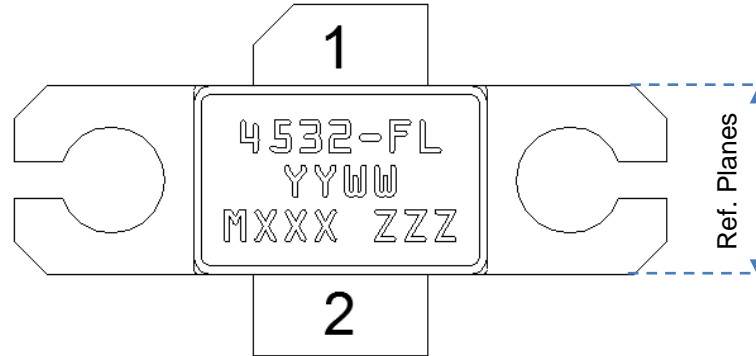

TOP VIEW

Notes:

- The T1G4004532-FL will be marked with the “4532-FL” designator and a lot code marked below the part designator. The “YY” represents the last two digits of the calendar year the part was manufactured, the “WW” is the work week of the assembly lot start, the “MXXX” is the production lot number, and the “ZZZ” is an auto-generated serial number.

Pin Description

Pin	Symbol	Description
1	VG / RF IN	Gate voltage / RF Input
2	VD / RF OUT	Drain voltage / RF Output
3	Flange	Source to be connected to ground

Mechanical Drawing¹

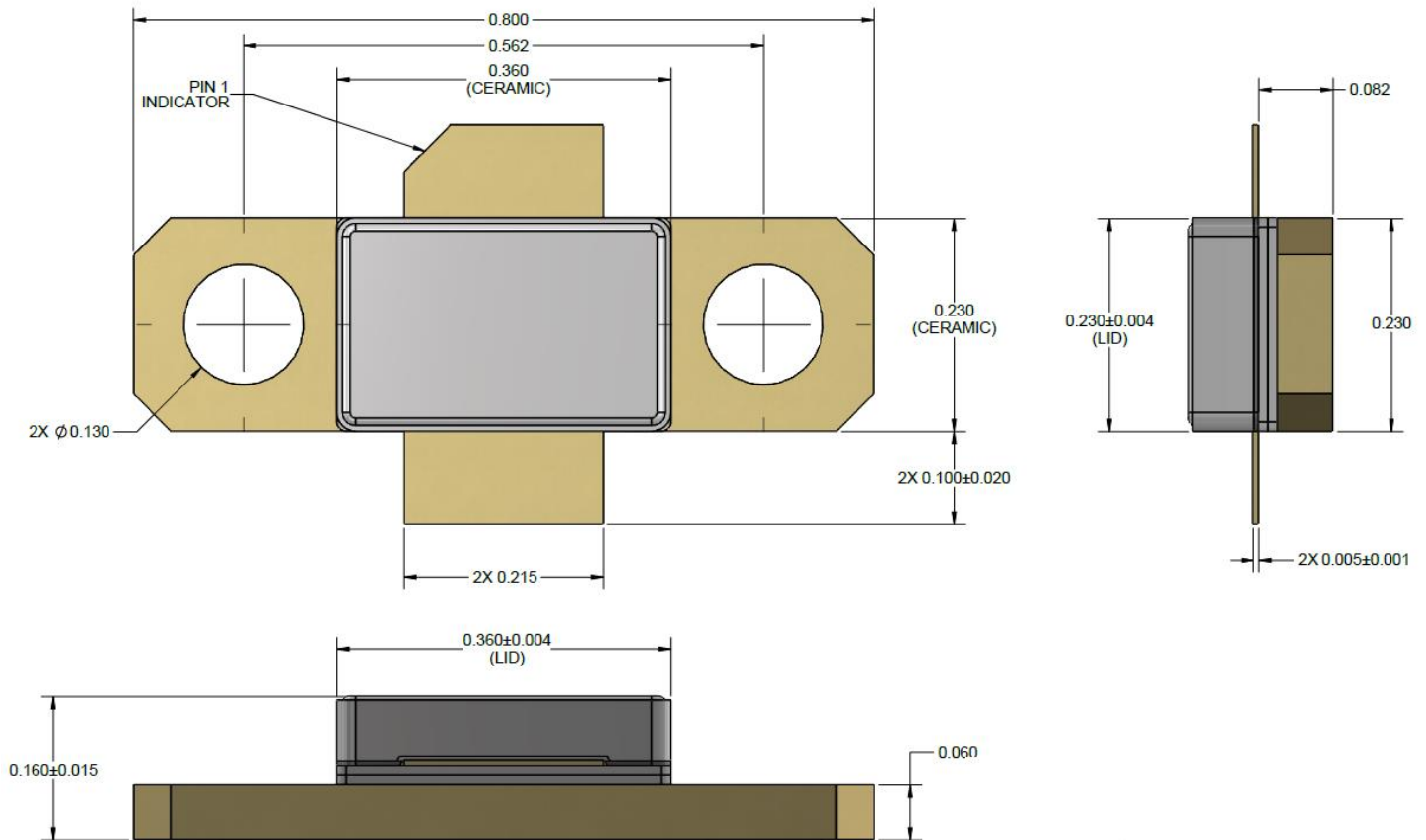

Note 1:

1. All dimensions are in inches. Angles are in degrees.
2. Dimension tolerance is ± 0.005 inches, unless otherwise noted.
3. Material:
Package Base: Ceramic / Metal
Package Lid: Ceramic
4. Package exposed metallization is gold plated.
5. Part is epoxy sealed.
6. Part meets industry NI360 footprint.
7. Body dimensions do not include epoxy runout which can be up to 0.020 inches per side.

2.7 – 3.5 GHz Application Circuit - Schematic

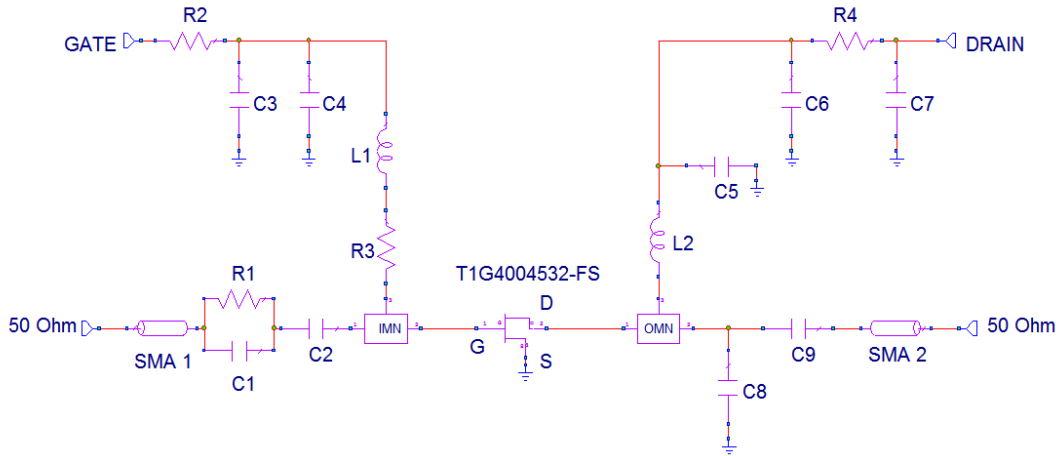

Bias-up Procedure	Bias-down Procedure
1. Set V_G to -4 V.	1. Turn off RF signal.
2. Set I_D current limit to 250 mA.	2. Turn off V_D
3. Apply 32 V V_D .	3. Wait 2 seconds to allow drain capacitor to discharge
4. Slowly adjust V_G until I_D is set to 220 mA.	4. Turn off V_G
5. Set I_D current limit to 0.7 A (Pulsed operation)	
6. Apply RF.	

2.7 – 3.5 GHz Application Circuit – Layout¹

Note 1: Board material is RO4350B 0.032" thickness with 1oz copper cladding.

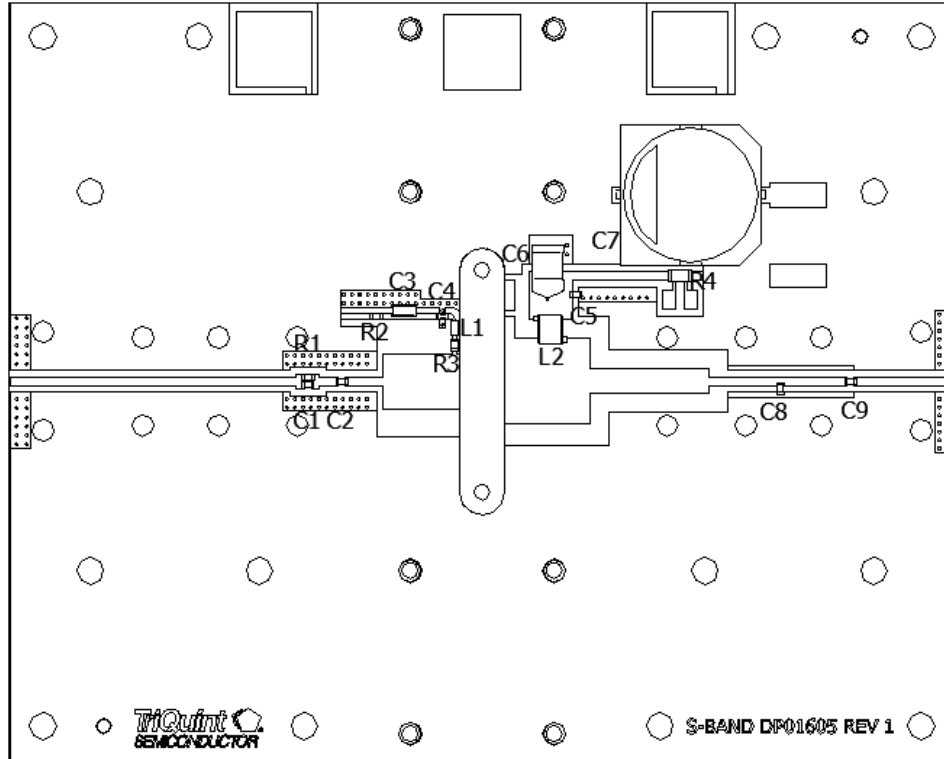

2.7 – 3.5 GHz Application Circuit - Bill Of material

Ref Des	Value	Qty	Manufacturer	Part Number
C1, C2, C9	5.6 pF	3	ATC	600S5R6AW250T
C3	10 uF	1	TDK	C1632X5R0J106M
C4	1.0 uF	1	Murata	NFM18PS105R0J3
C5	100 pF	1	ATC	600S100AW250T
C6	10 uF	1	Vishay Sprague	595D106X9035D2T
C7	220 uF	1	AFK	AFK227M2AR44B
C8	0.7 pF	1	ATC	600S0R7AW250T
L1	3.6 nH	1	Coilcraft	0603HC-3N6XJL
L2	6.6 nH	1	Coilcraft	GA3093-ALB
R1	100 Ohms	1	Vishay Dale	CRCW0603100RFKEC
R2, R3	10 Ohms	2	Vishay Dale	CRCW060310R0FKEA
R4	0.01 Ohms	1	Panasonic	ERJ-8BWJR010V

Recommended Solder Temperature Profile

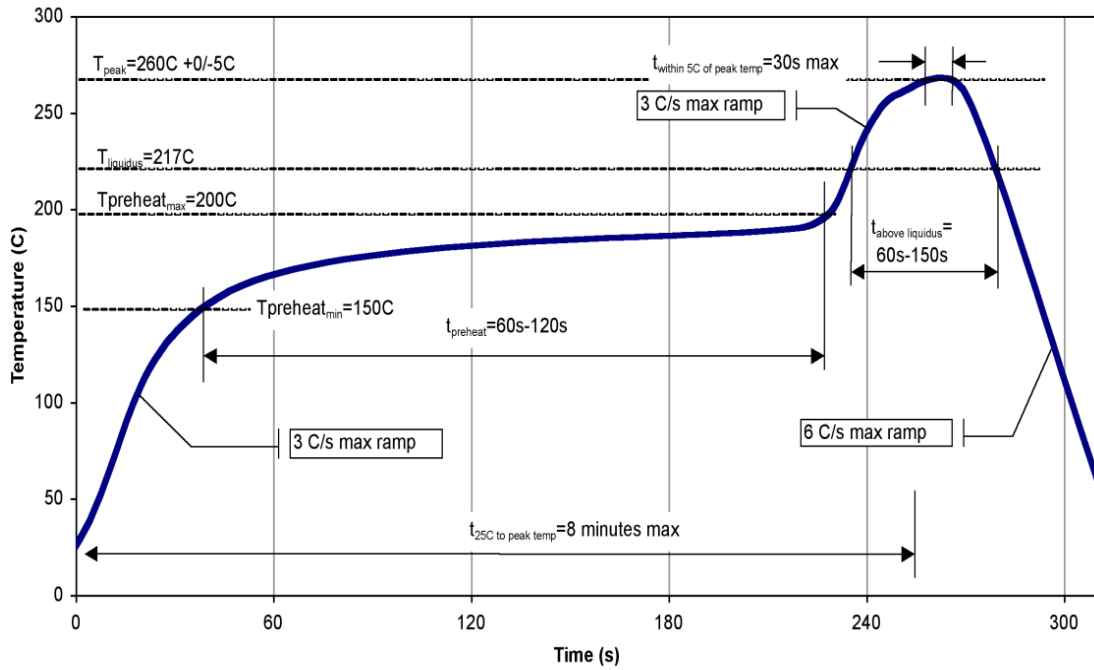

Handling Precautions

Parameter	Rating	Standard
ESD – Human Body Model (HBM)	Class 1A ≥ 400 V	ANSI/ESD/JEDEC JS-001
ESD – Charged Device Model (CDM)	Class C3 ≥ 1000 V	ANSI/ESD/JEDEC JS-002
MSL – Moisture Sensitivity Level	MSL3	IPC/JEDEC J-STD-020



Caution!
ESD-Sensitive Device

Solderability

Compatible with both lead-free (260°C max. reflow temp.) and tin/lead (245°C max. reflow temp.) soldering processes. Solder profiles available upon request.

Contact plating: NiAu. Au thickness is 60 microinches minimum.

RoHS Compliance

This part is compliant with 2011/65/EU RoHS directive (Restrictions on the Use of Certain Hazardous Substances in Electrical and Electronic Equipment) as amended by Directive 2015/863/EU.

This product also has the following attributes:

- Lead Free
- Halogen Free (Chlorine, Bromine)
- Antimony Free
- TBBP-A (C₁₅H₁₂Br₄O₂) Free
- PFOS Free
- SVHC Free



Contact Information

For the latest specifications, additional product information, worldwide sales and distribution locations, and information about Qorvo:

Web: www.qorvo.com
 Email: customer.support@tqs.com

Tel: +1.844.890.8163

For technical questions and application information: Email: info-products@qorvo.com

Important Notice

The information contained herein is believed to be reliable; however, Qorvo makes no warranties regarding the information contained herein and assumes no responsibility or liability whatsoever for the use of the information contained herein. All information contained herein is subject to change without notice. Customers should obtain and verify the latest relevant information before placing orders for Qorvo products. The information contained herein or any use of such information does not grant, explicitly or implicitly, to any party any patent rights, licenses, or any other intellectual property rights, whether with regard to such information itself or anything described by such information. **THIS INFORMATION DOES NOT CONSTITUTE A WARRANTY WITH RESPECT TO THE PRODUCTS DESCRIBED HEREIN, AND QORVO HEREBY DISCLAIMS ANY AND ALL WARRANTIES WITH RESPECT TO SUCH PRODUCTS WHETHER EXPRESS OR IMPLIED BY LAW, COURSE OF DEALING, COURSE OF PERFORMANCE, USAGE OF TRADE OR OTHERWISE, INCLUDING THE IMPLIED WARRANTIES OF MERCHANTABILITY AND FITNESS FOR A PARTICULAR PURPOSE.**

Without limiting the generality of the foregoing, Qorvo products are not warranted or authorized for use as critical components in medical, life-saving, or life-sustaining applications, or other applications where a failure would reasonably be expected to cause severe personal injury or death.

Copyright 2016 © Qorvo, Inc. | Qorvo is a registered trademark of Qorvo, Inc.

Mouser Electronics

Authorized Distributor

Click to View Pricing, Inventory, Delivery & Lifecycle Information:

[Qorvo:](#)

[T1G4004532-FL](#)