



RFSA3043 75Ω Voltage Controlled Attenuator (5 – 3000 MHz)

Product Overview

The RFSA3043 is a fully monolithic analog voltage-controlled attenuator (VCA) featuring exceptional linearity over a typical temperature compensated 30 dB gain control range. It incorporates a revolutionary new circuit architecture to solve a long-standing industry problem: high IP3, high attenuation range, low DC current, broad bandwidth and temperature compensated linear in dB control voltage characteristic. This voltage-controlled attenuator is controlled by a single positive control voltage with on-chip DC conditioning circuitry. The slope of the control voltage versus gain is selectable. The RFSA3043 draws a very low 2 mA current and is packaged in a small 3 mm x 3 mm QFN. This attenuator is matched to 75 Ω over its rated control range and frequency with no external matching components required.

Functional Block Diagram

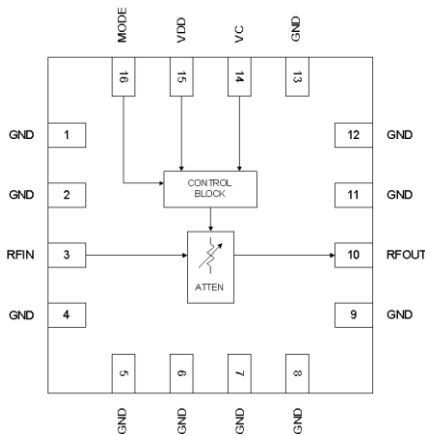

Top View

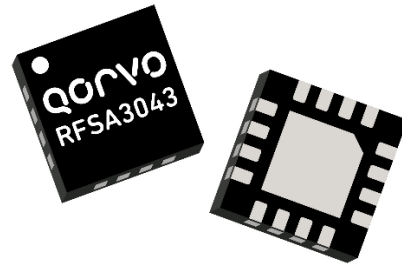

QFN, 16-pin, 3.0 mm x 3.0 mm

Key Features

- Broadband 5 – 3000 MHz frequency range
- 30 dB attenuation range
- +50 dBm Input IP3 (typical)
- +80 dBm Input IP2 (typical)
- Low Distortion: -80 dBc CSO and -75 dBc CTB for 132 channel 38 dBmV input
- High 1 dB compression point (> +30 dBm)
- Low supply current: 2 mA (typical)
- 3 V to 5 V power supply
- Linear in dB control characteristic

Applications

- Cable Modems
- CATV
- High Linearity Power Control

Ordering Information

Part Number	Description
RFSA3043SQ	Sample Bag with 25 Pieces
RFSA3043TR7	7" Reel with 2500 Pieces
RFSA3043PCK-410	EVB with 5 Piece Sample Bag

Absolute Maximum Ratings

Parameter	Rating
Control Voltage (V _c)	-0.5 to +6.0 V
Supply Voltage (V _{DD})	-0.5 to +6.0 V
Mode Pin Voltage (MODE)	-0.5 to +6.0 V
Storage Temperature Range	-65 to +150 °C

Exceeding any one or a combination of the Absolute Maximum Rating conditions may cause permanent damage to the device. Extended application of Absolute Maximum Rating conditions to the device may reduce device reliability.

Recommended Operating Conditions

Parameter	Min	Typ	Max	Units
Operating Temperature	-40		+105	°C
Junction Temperature			+125	°C
RF Power Supply Voltage	3	5	5.5	V

Electrical specifications are measured at specified test conditions. Specifications are not guaranteed over all recommended operating conditions.

Electrical Specifications

Parameter	Condition ⁽¹⁾	Min	Typ	Max	Unit
Supply Current (I _{SS})	Steady state operation, current draw during attenuation state transitions is higher.		2		mA
Thermal Resistance	T _{REF} taken at +85 °C from backside of PCB		35		°C / W
RF Input Power				27	dBm
Frequency Range		5		3000	MHz
Minimum Insertion Loss			1.5	2.0	dB
Gain Control Range		30	35		dB
Gain v Temperature	Peak to peak gain variation over temperature for fixed control voltage		1.5		dB
Return Loss			15		dB
Relative Phase	Insertion phase at 15 dB attenuation relative to Minimum attenuation		5		degree
Input 1 dB Compression Point			30		dBm
Input IP3	P _{IN} + (IM _{3dBc} /2)		50		dBm
Input IP2	P _{IN} + (IM _{2dBc}) IM2 is f1 + f2		80		dBm
Input IH2	P _{IN} + H _{2dBc} H2 is second harmonic		85		dBm
Input IH3	P _{IN} + (H _{3dBc} /2) H3 is third harmonic		55		dBm
CSO	55.25 MHz to 865.25 MHz, 132 channel, +38 dBmV Input, flat tilt		-80		dBc
CTB			-75		dBc
XMOD			-70		dBc
Voltage Control Range Positive Attenuation Slope	5 V control voltage is lowest insertion loss MODE pin high	0		5	V
Voltage Control Range Negative Attenuation Slope	0 V control voltage is lowest insertion loss MODE pin low	0		5	V
Voltage Control Pin Current	V _c pin at 5 V MODE pin high		37		μA
Voltage Control Pin Current	V _c pin at 5 V MODE pin low		37		μA
MODE Pin Logic Low				0.4	V
MODE Pin Logic High		1			V
Setting Time	1 dB attenuation change settling with 0.1 dB		10		μSec

Notes:

1. Typical performance at these conditions: Temp. = +25 °C, V_{DD} = +5 V, 1000 MHz

Evaluation Board Schematic

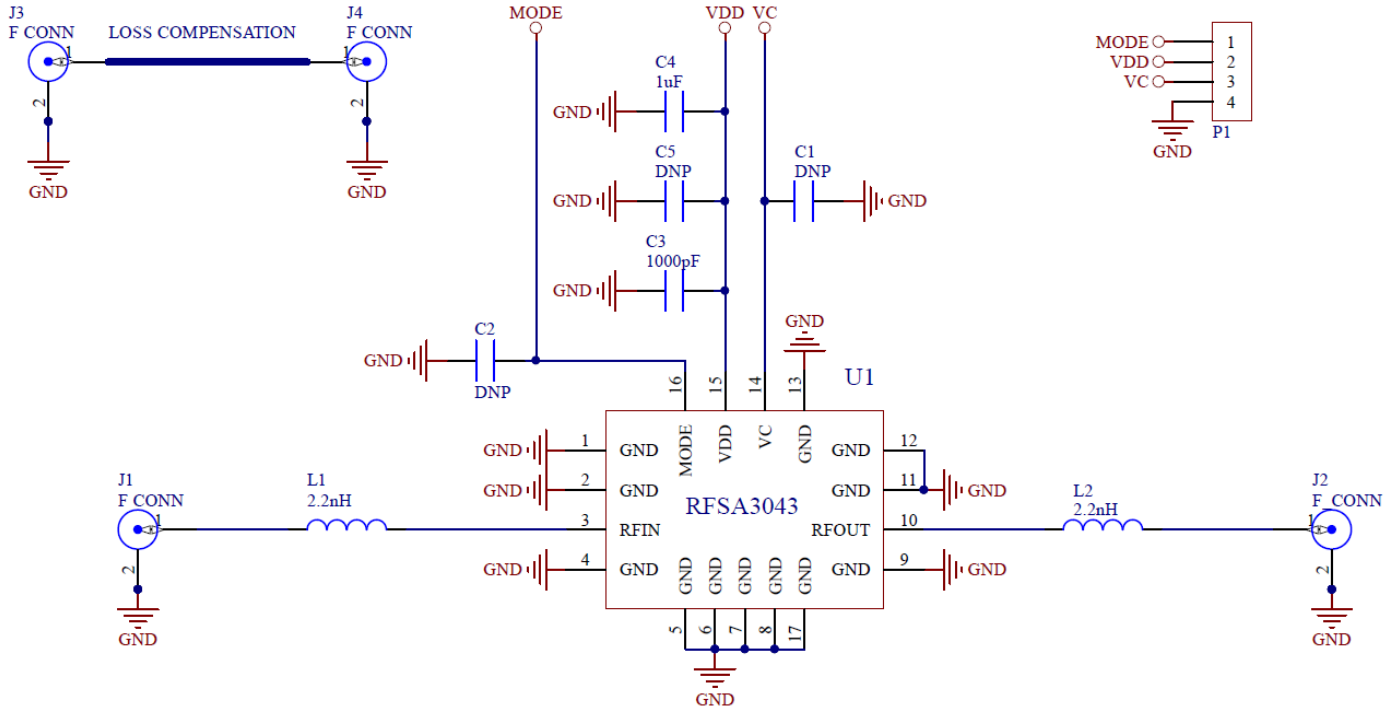

Bill of Materials

Ref Des	Description	Manufacturer	Manufacturer Part #
U1	CATV Voltage Controlled Attenuator	Qorvo	RFSA3043
PCB	SA3043-410 Evaluation Board	DDI	SA3043-410(B)
J1-J4	CONN, F FEM EDGE MOUNT, 75Ω, 0.065"	Genesis Technology USA	GT20-300204
P1	CONN, HDR, ST, 4-PIN, 0.100"	Samtec, Inc.	TSW-104-08-S-S
C3	CAP, 1000 pF, 10%, 25 V, X7R, 0402	Murata Electronics	GRM155R71H102KA01D
C4	CAP, 1 μF, 10%, 16 V, X7R, 1206	Murata Electronics	500R07S0R8AV4T
L1, L2	IND, 2.2 nH, +/-0.1 nH, T/F, 0402	Murata Electronics	LQP15MN2N2B02D
C1, C2, C5	DNP	N/A	N/A

Evaluation Board Assembly Drawing

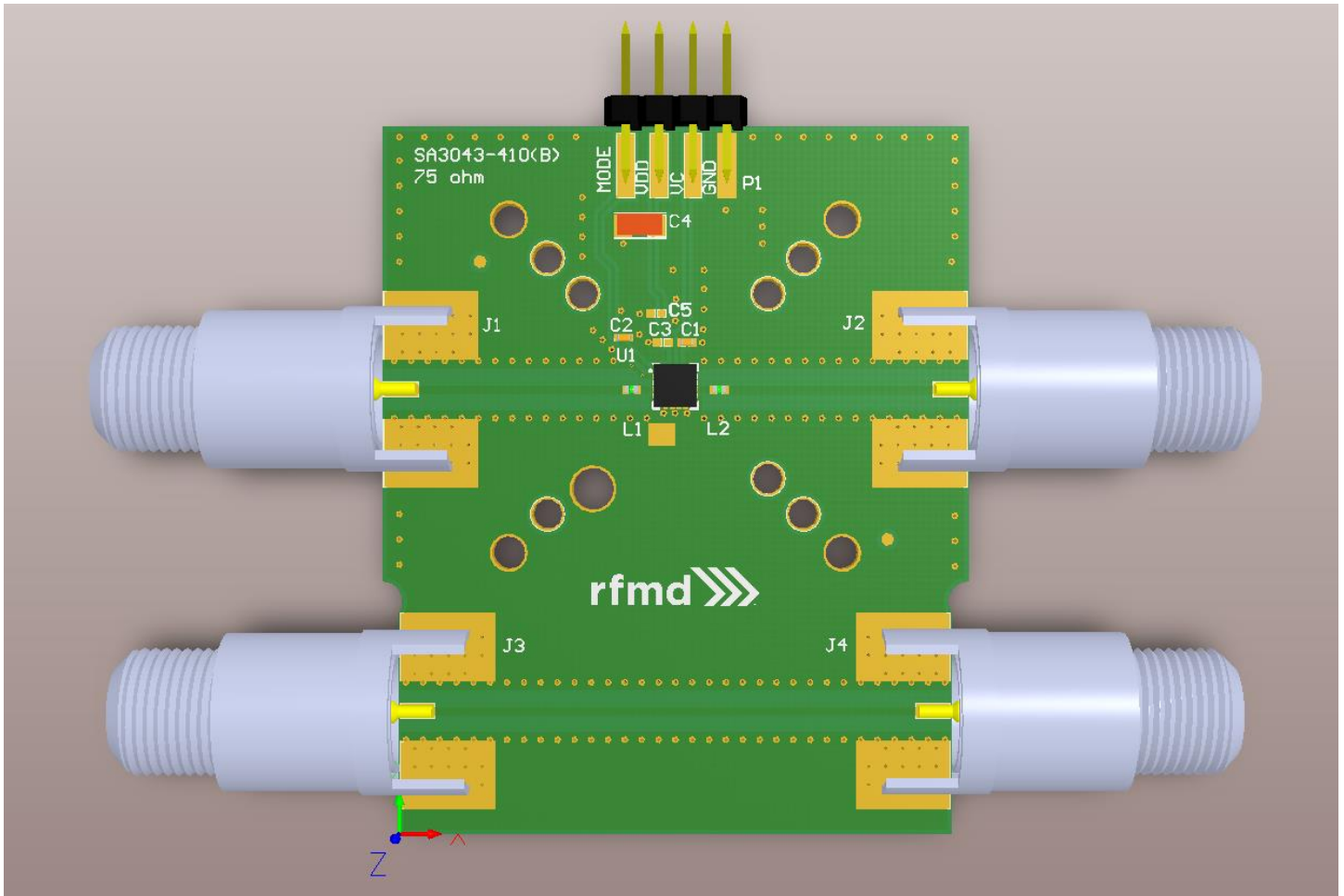

Note: J3-J4 used for loss compensation

Application Schematic

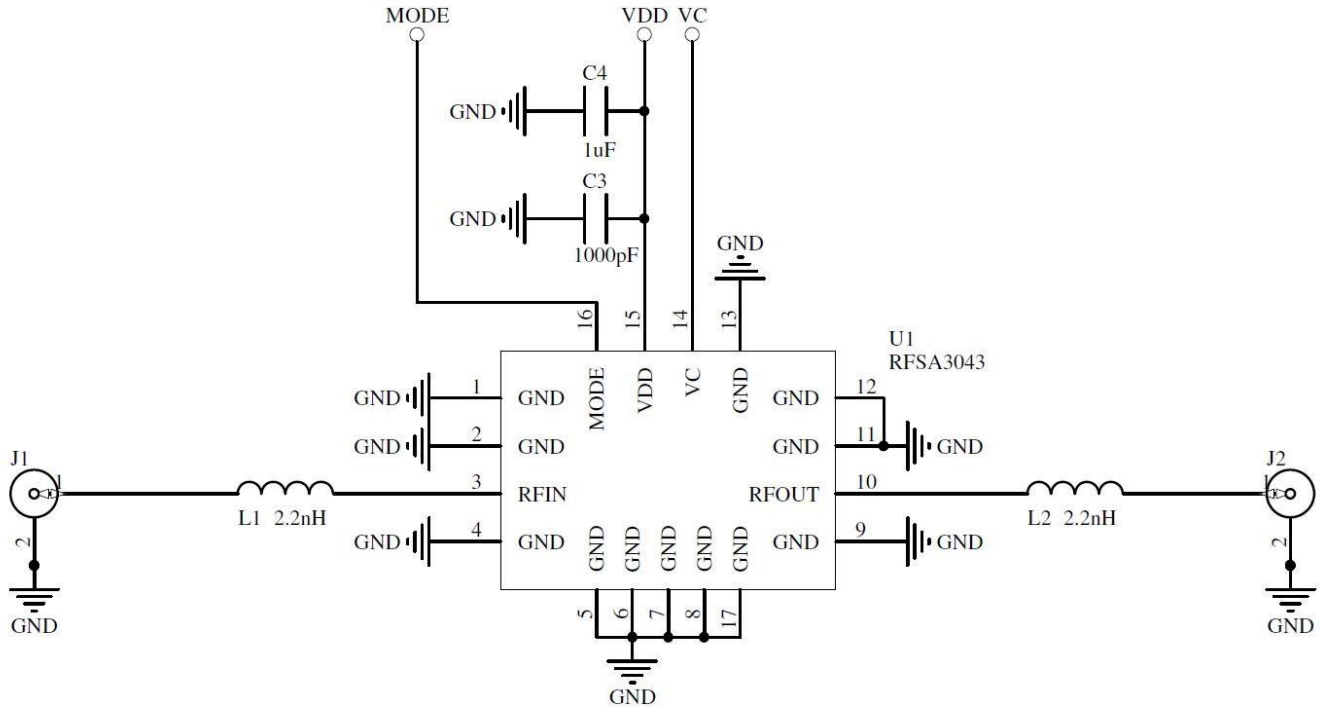

Performance Data

Test conditions unless otherwise stated: Temp.= +25 °C, V_{DD} = +5 V, Frequency = 2000 MHz

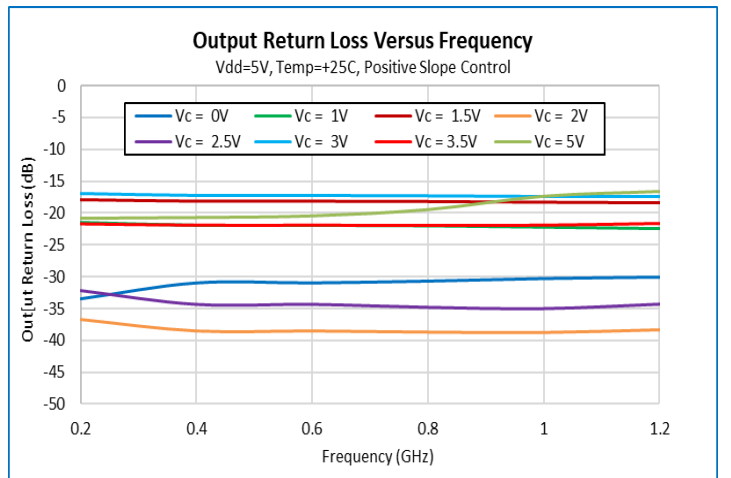
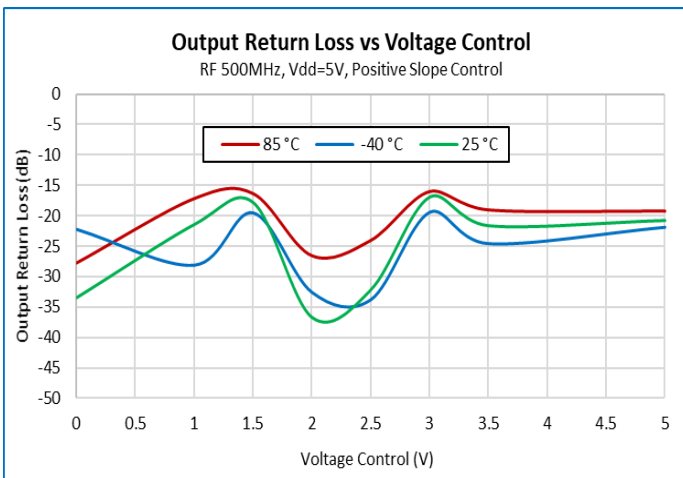
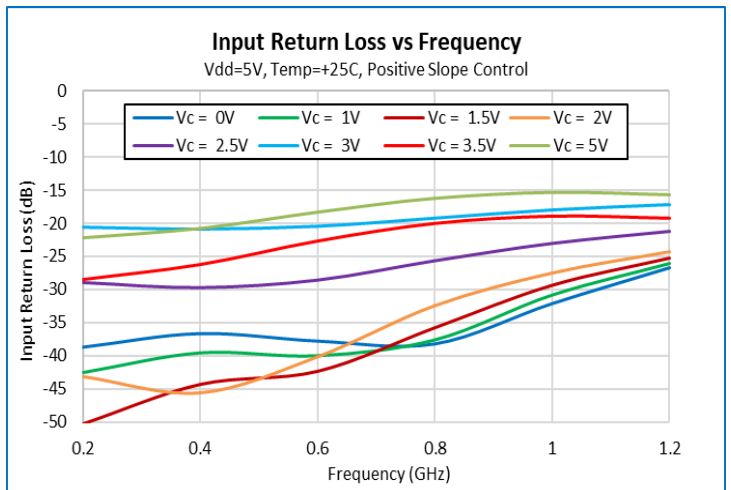
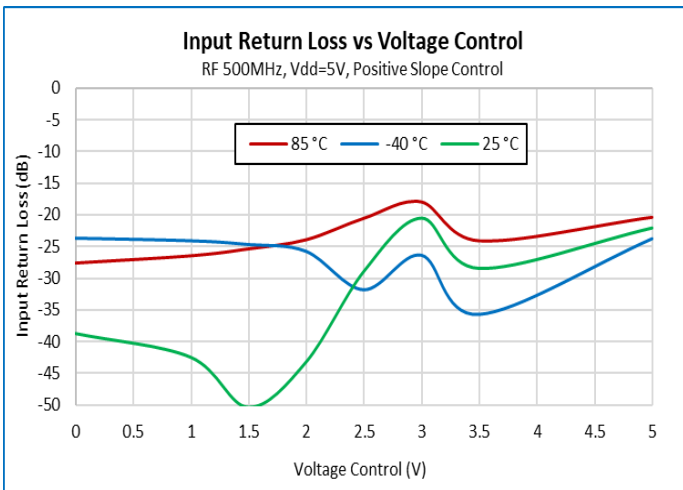
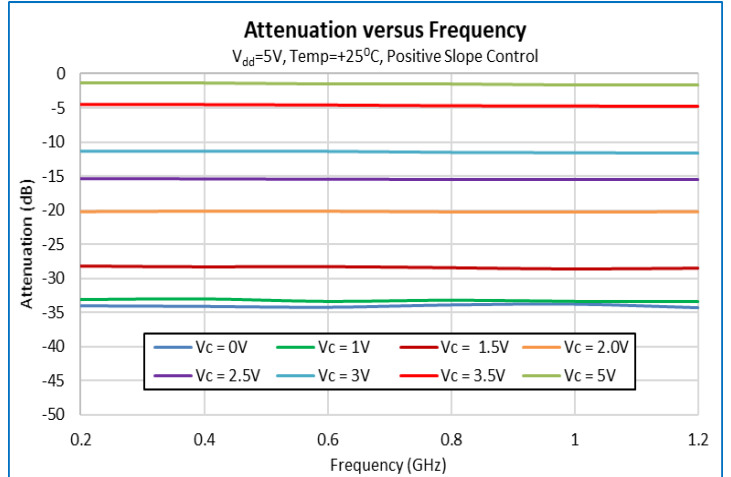
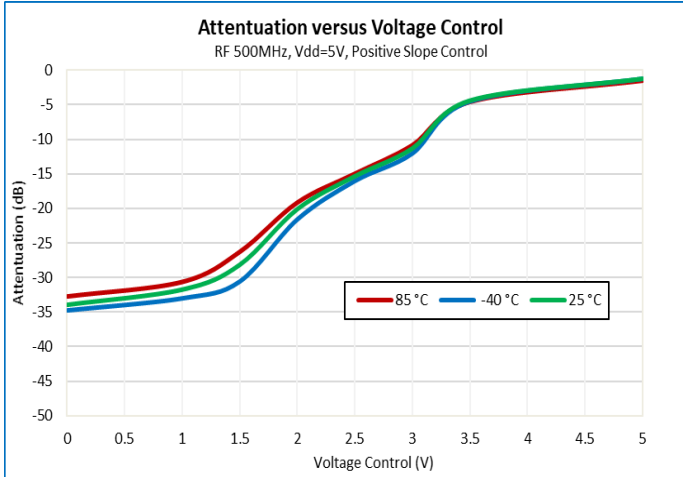

Performance Data (continued)

Test conditions unless otherwise stated: Temp.= +25 °C, V_{DD} = +5 V, Frequency = 2000 MHz

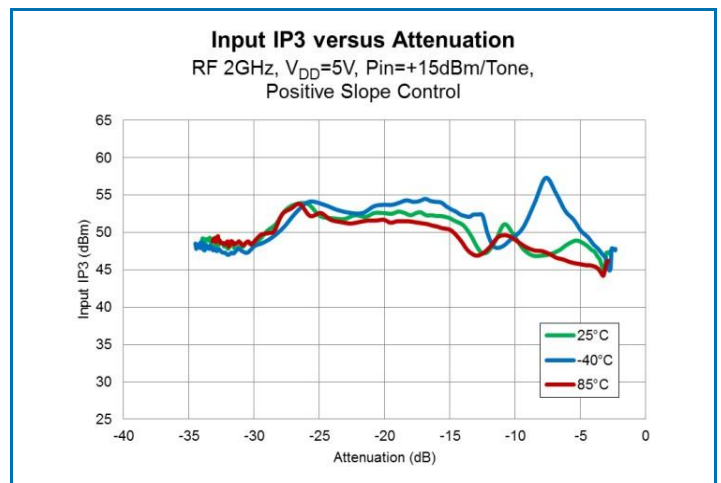
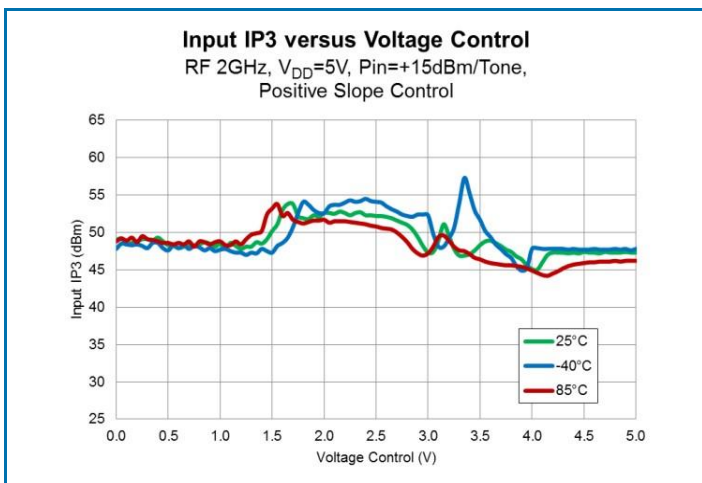
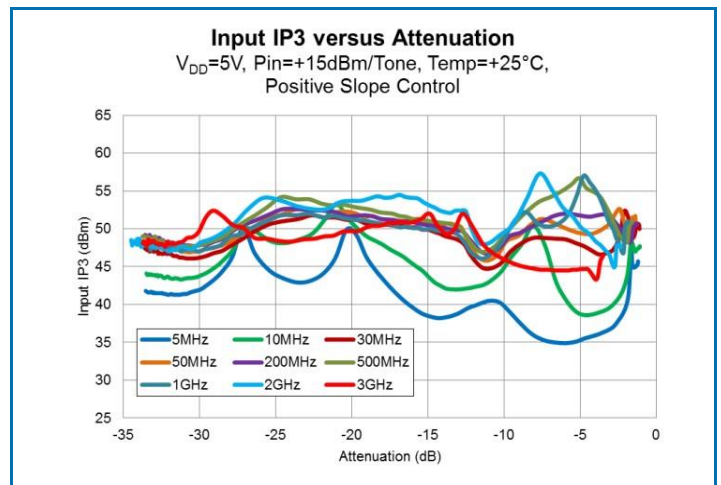
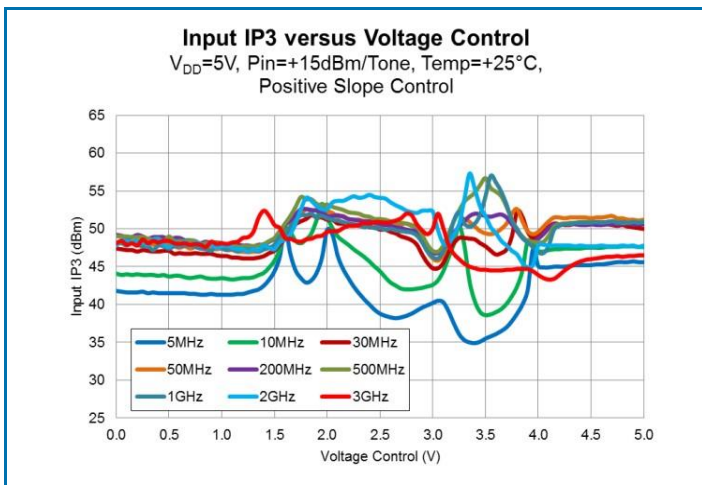
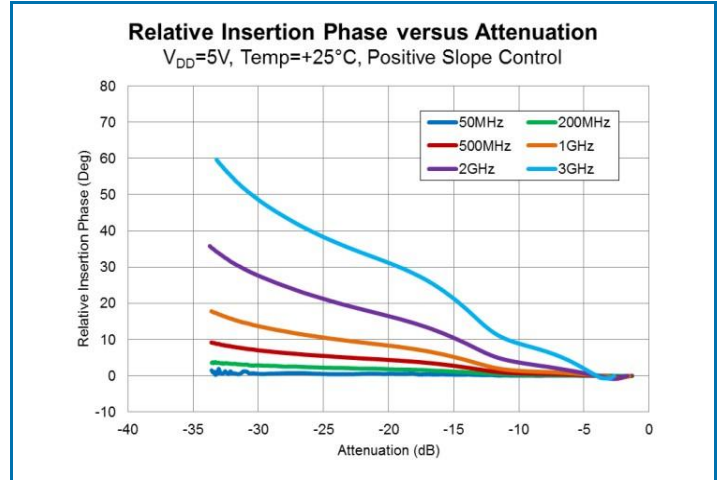
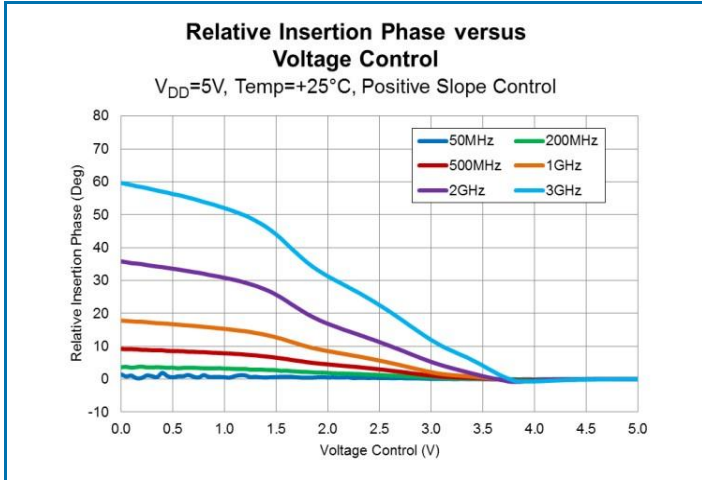

Performance Data (continued)

Test conditions unless otherwise stated: Temp.= +25 °C, V_{DD} = +5 V, Frequency = 2000 MHz

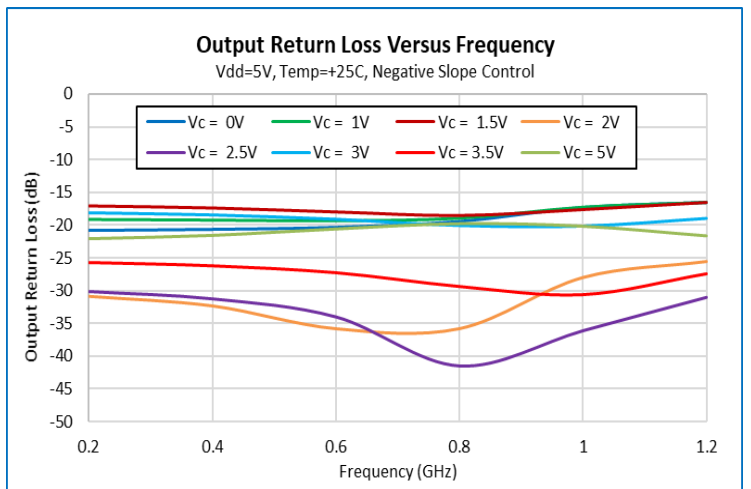
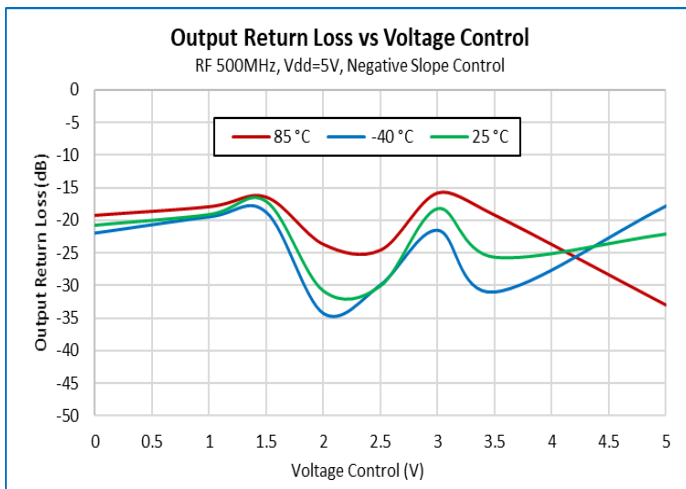
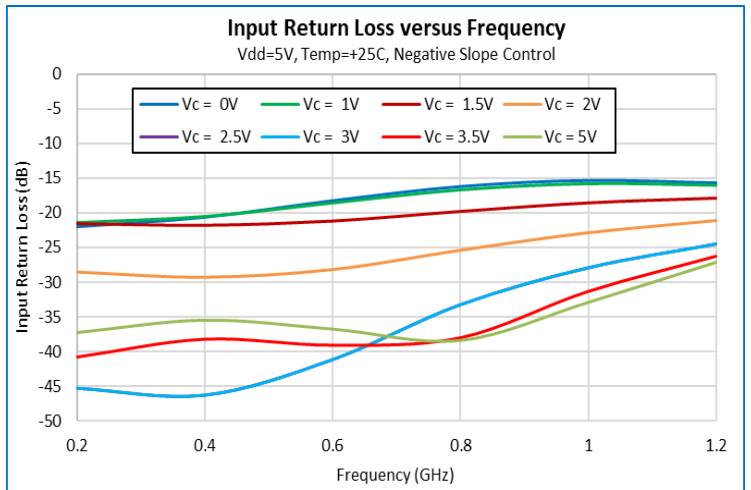
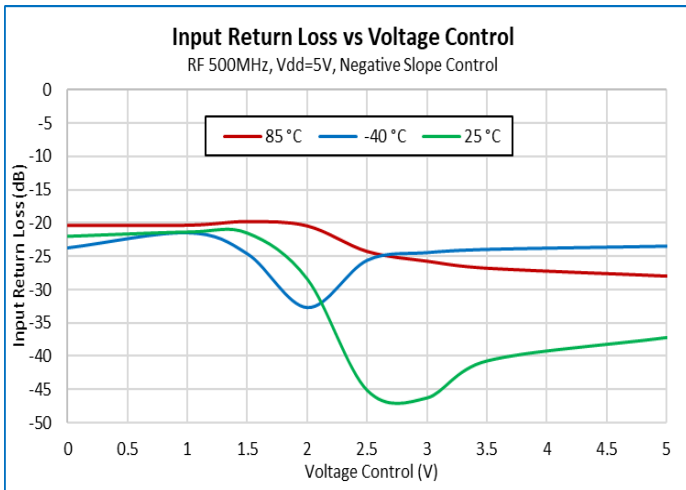
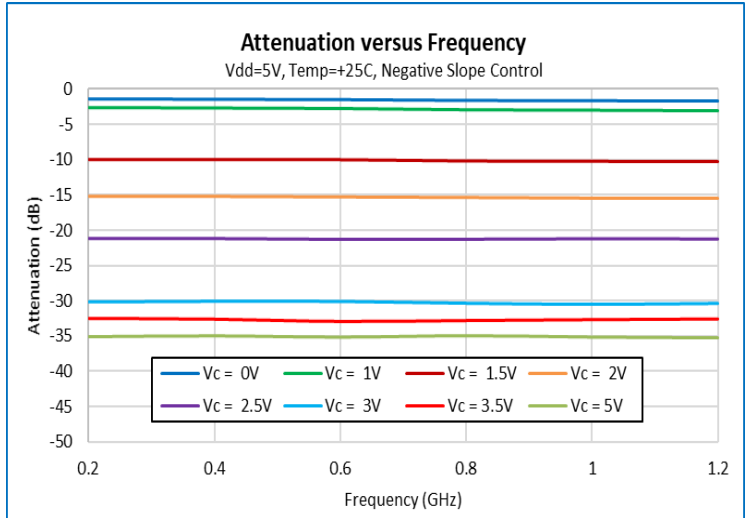
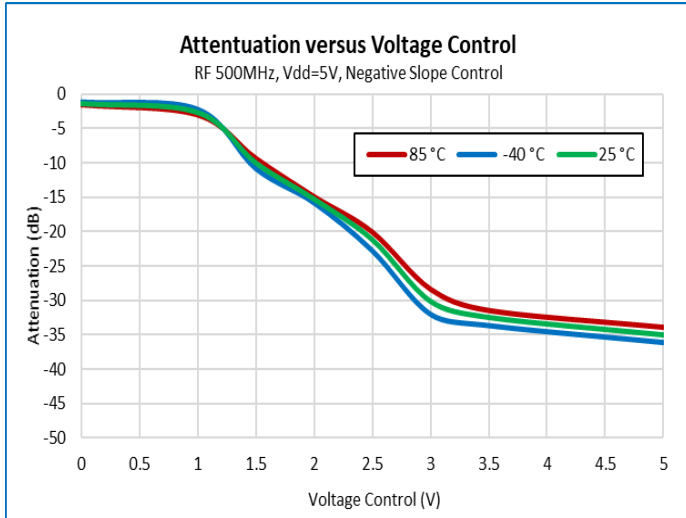

Performance Data (continued)

Test conditions unless otherwise stated: Temp.= +25 °C, V_{DD} = +5 V, Frequency = 500 MHz

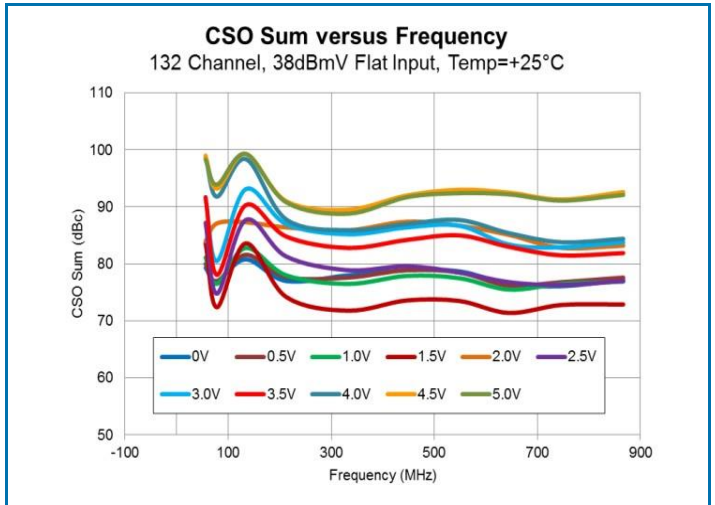
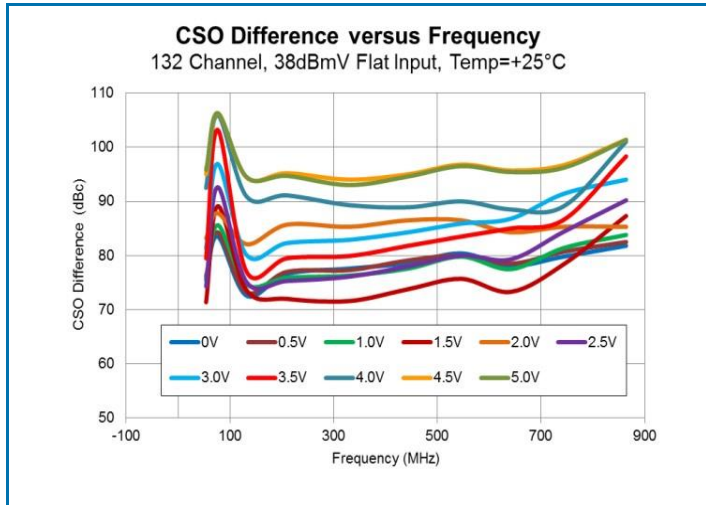
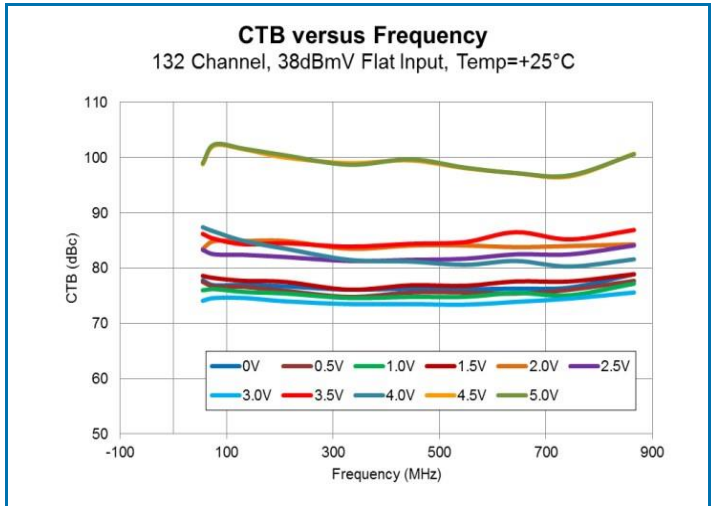
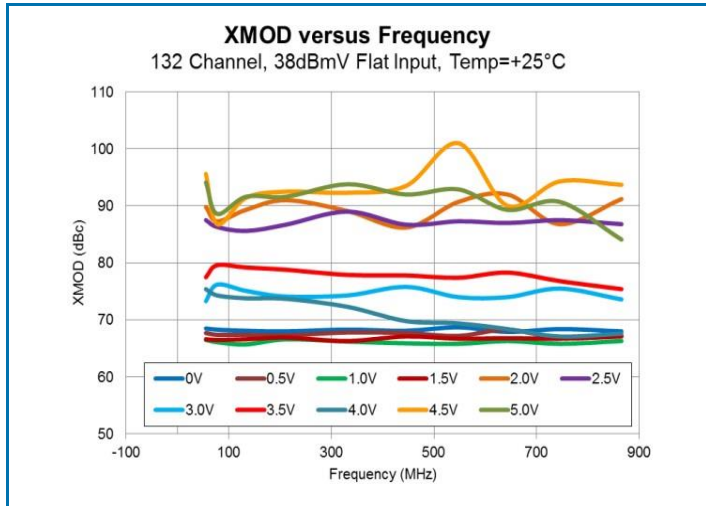

Notes: L1 and L2 = 0Ω

Package Dimensions

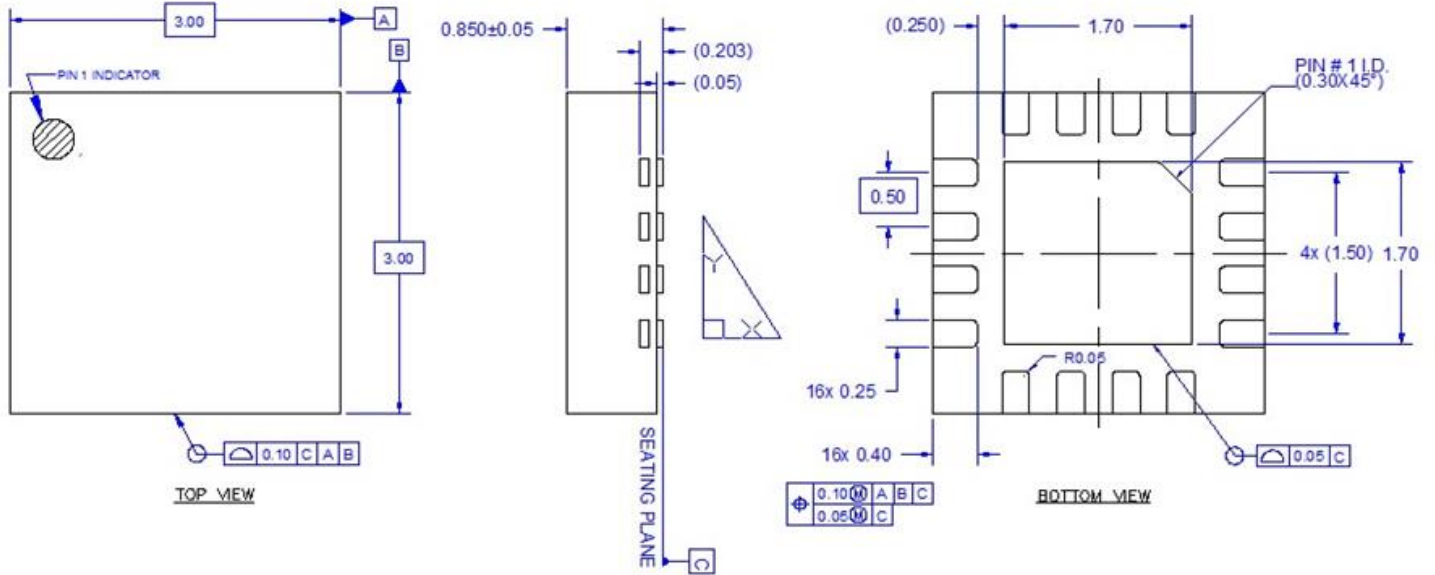

- Notes:
 1. Dimensions in millimeters

Package Marking

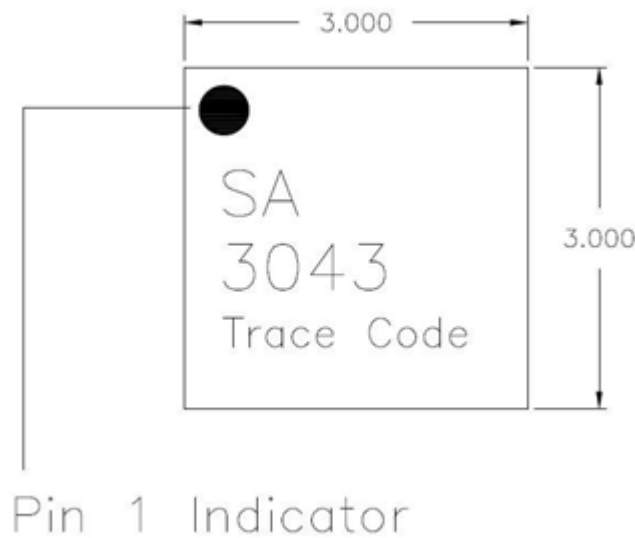

Pin Configuration and Description

Pin	Name	Description
1	GND	Ground Pin
2	GND	Ground Pin
3	RF IN	RF Input, use external DC block. RF input must be this pin to insure linearity and thermal resistance specifications.
4	GND	Ground Pin
5	GND	Ground Pin
6	GND	Ground Pin
7	GND	Ground Pin
8	GND	Ground Pin
9	GND	Ground Pin
10	RF OUT	RF Output, use external DC block. RF output must be this pin to insure linearity and thermal resistance specifications.
11	GND	Ground Pin
12	GND	Ground Pin
13	GND	Ground Pin
14	V _c	Attenuator Control Voltage
15	V _{DD}	Supply Voltage
16	MODE	Attenuation Slope Control Set logic LOW to enable negative attenuation slope Set logic HIGH to enable positive attenuation slope

Handling Precautions

Parameter	Rating	Standard
ESD – Human Body Model (HBM)	Class 2 (2000 V)	ESDA / JEDEC JS-001-2010
ESD – Charged Device Model (CDM)	Class C3 (1000 V)	JEDEC JESD22-C101
MSL – Moisture Sensitivity Level	Level 1	IPC / JEDEC J-STD-020



Caution!
ESD-Sensitive Device

Solderability

Compatible with both lead-free (260 °C max. reflow temp.) and tin/lead (245 °C max. reflow temp.) soldering processes.
Solder profiles available upon request.

Contact plating: Matte Sn

RoHS Compliance

This part is compliant with 2011 / 65 / EU RoHS directive (Restrictions on the Use of Certain Hazardous Substances in Electrical and Electronic Equipment) as amended by Directive 2015 / 863 / EU.

This product also has the following attributes:

- Lead Free
- Halogen Free (Chlorine, Bromine)
- Antimony Free
- TBBP-A (C₁₅H₁₂Br₄O₂) Free
- SVHC Free
- PFOS Free



Contact Information

For the latest specifications, additional product information, worldwide sales and distribution locations:

Web: www.qorvo.com

Tel: 1-844-890-8163

Email: customer.support@qorvo.com

Important Notice

The information contained in this Data Sheet and any associated documents (“Data Sheet Information”) is believed to be reliable; however, Qorvo makes no warranties regarding the Data Sheet Information and assumes no responsibility or liability whatsoever for the use of said information. All Data Sheet Information is subject to change without notice. Customers should obtain and verify the latest relevant Data Sheet Information before placing orders for Qorvo® products. Data Sheet Information or the use thereof does not grant, explicitly, implicitly or otherwise any rights or licenses to any third party with respect to patents or any other intellectual property whether with regard to such Data Sheet Information itself or anything described by such information.

DATA SHEET INFORMATION DOES NOT CONSTITUTE A WARRANTY WITH RESPECT TO THE PRODUCTS DESCRIBED HEREIN, AND QORVO HEREBY DISCLAIMS ANY AND ALL WARRANTIES WITH RESPECT TO SUCH PRODUCTS WHETHER EXPRESS OR IMPLIED BY LAW, COURSE OF DEALING, COURSE OF PERFORMANCE, USAGE OF TRADE OR OTHERWISE, INCLUDING THE IMPLIED WARRANTIES OF MERCHANTABILITY AND FITNESS FOR A PARTICULAR PURPOSE. Without limiting the generality of the foregoing, Qorvo® products are not warranted or authorized for use as critical components in medical, life-saving, or life-sustaining applications, or other applications where a failure would reasonably be expected to cause severe personal injury or death. Applications described in the Data Sheet Information are for illustrative purposes only. Customers are responsible for validating that a particular product described in the Data Sheet Information is suitable for use in a particular application.

© 2021 Qorvo US, Inc. All rights reserved. This document is subject to copyright laws in various jurisdictions worldwide and may not be reproduced or distributed, in whole or in part, without the express written consent of Qorvo US, Inc. | QORVO® is a registered trademark of Qorvo US, Inc.

Mouser Electronics

Authorized Distributor

Click to View Pricing, Inventory, Delivery & Lifecycle Information:

[Qorvo:](#)

[RFSA3043](#) [RFSA3043TR7](#) [RFSA3043SR](#) [RFSA3043PCK-410](#)