

Product Description

The RFCM4363 is a Push Pull amplifier SMD Module. The part employs GaAs MESFET, GaAs pHEMT and GaN HEMT die and is operated from 45MHz to 1218MHz. It provides excellent linearity and superior return loss performance with low noise and optimal reliability. DC current of the device can be externally adjusted for optimum distortion performance versus power consumption over a wide range of output level.

Functional Block Diagram

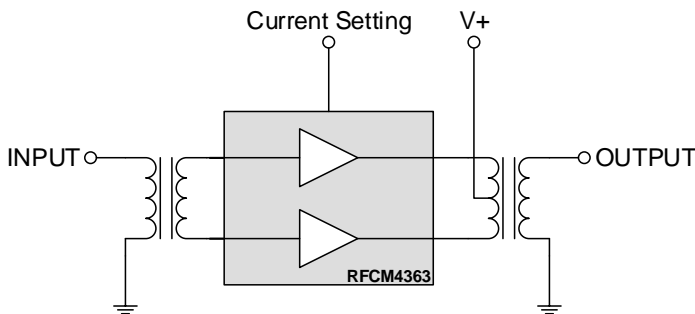

9 pin, 11.0 mm x 8.5 mm x 1.375 mm package

Product Features

- Excellent Linearity
- Superior Return Loss Performance
- Extremely Low Distortion
- Optimal Reliability
- Low Noise
- Unconditionally Stable Under all Terminations
- 27.5 dB Min Gain at 1218 MHz
- 270 mA Max at 24 VDC

Applications

- 45 – 1218 MHz CATV Amplifier Systems

Ordering Information

Part No.	Description
RFCM4363SB	Sample bag 5 pcs
RFCM4363SR	7" Reel with 100 pcs
RFCM4363TR7	7" Reel with 500 pcs
RFCM4363PCBA-410	Fully assembled Evaluation Board
RFCM4363PCK-410	Fully assembled Evaluation Board with Sample Bag

Absolute Maximum Ratings

Parameter	Value / Range
DC Supply over-voltage (5 minutes)	+30 V
Storage Temperature	-40 to 100 °C
Operating Mounting Base Temperature	-30 to 100 °C
Moisture Sensitivity Level IPC/JEDEC J-STD-20	MSL 3 @ 260 °C
RF Input Voltage (single tone; on Evaluation Board)	70 dBmV

Operation of this device outside the parameter ranges given above may cause permanent damage.

Electrical Specifications – part 1

Parameter	Conditions (V+=24V, TMB=30°C, ZS=ZL=75Ω, Pin3 not connected)	Min	Typ	Max	Units
Operational Frequency Range	–	45	–	1218	MHz
Current (I _{DD})	–		260	270	mA
Gain	f _o = 45 MHz		27.0		dB
Gain	f _o = 1218 MHz	27.5	28.0	29.0	
Gain Slope	45 to 1218 MHz ^[1]	0.5	1.0	2.0	
Gain Flatness	45 to 1218 MHz (Peak to valley)			0.8	
Thermal Resistance	Junction to Mounting Base		3.3		K/W
Input Return Loss	f _o = 45 to 320 MHz	20		–	dB
	f _o = 320 to 640 MHz	19		–	
	f _o = 640 to 870 MHz	18		–	
	f _o = 870 to 1003 MHz	17		–	
	f _o = 1003 to 1218 MHz	16		–	
Output Return Loss	f _o = 45 to 320 MHz	20		–	dB
	f _o = 320 to 640 MHz	19		–	
	f _o = 640 to 870 MHz	18		–	
	f _o = 870 to 1003 MHz	17		–	
	f _o = 1003 to 1218 MHz	16		–	
Noise Figure	f _o = 50 to 1218 MHz	–	4.6	5.5	dB

Electrical Specifications – part 2

Parameter	Conditions (V+=24V, TMB=30°C, ZS=ZL=75Ω, IDC=IDC (typ.))	Min	Typ	Max	Units
CTB	Vo=46 dBmV, flat, 79 analog channels plus 75 digital channels (-6dB offset) ^[2,4] , TCP ^[5] = 65.9dBmV		-69	-66	dBc
XMOD			-63	-60	dBc
CSO			-79	-70	dBc
CIN			69	67	dB
CTB	Vo=45 dBmV, flat, 79 analog channels plus 111 digital channels (-6dB offset) ^[3,4] , TCP ^[5] = 65.3dBmV		-72		dBc
XMOD			-65		dBc
CSO			-80		dBc
CIN			70		dB

1. The slope is defined as the difference between the gain at the start frequency and the gain at the stop frequency.
2. 79 analog channels, NTSC frequency raster: 55.25MHz to 547.25MHz, +46dBmV flat output level, plus 75 digital channels, -6dB offset relative to the equivalent analog carrier.
3. 79 analog channels, NTSC frequency raster: 55.25MHz to 547.25MHz, +45dBmV flat output level, plus 111 digital channels, -6dB offset relative to the equivalent analog carrier.
4. Composite Second Order (CSO) – The CSO parameter (both sum and difference products) is defined by ANSI/SCTE 6. Composite Triple Beat (CTB) – The CTB parameter is defined by ANSI/SCTE 6. Cross Modulation (XMOD) – Cross modulation (XMOD) is measured at baseband (selective voltmeter method), referenced to 100% modulation of carrier being tested, Carrier to Intermodulation Noise (CIN) – The CIN parameter is defined by ANSI/SCTE 17 (Test procedure for carrier to noise)
5. Total Composite Power

Evaluation Board Assembly Drawing

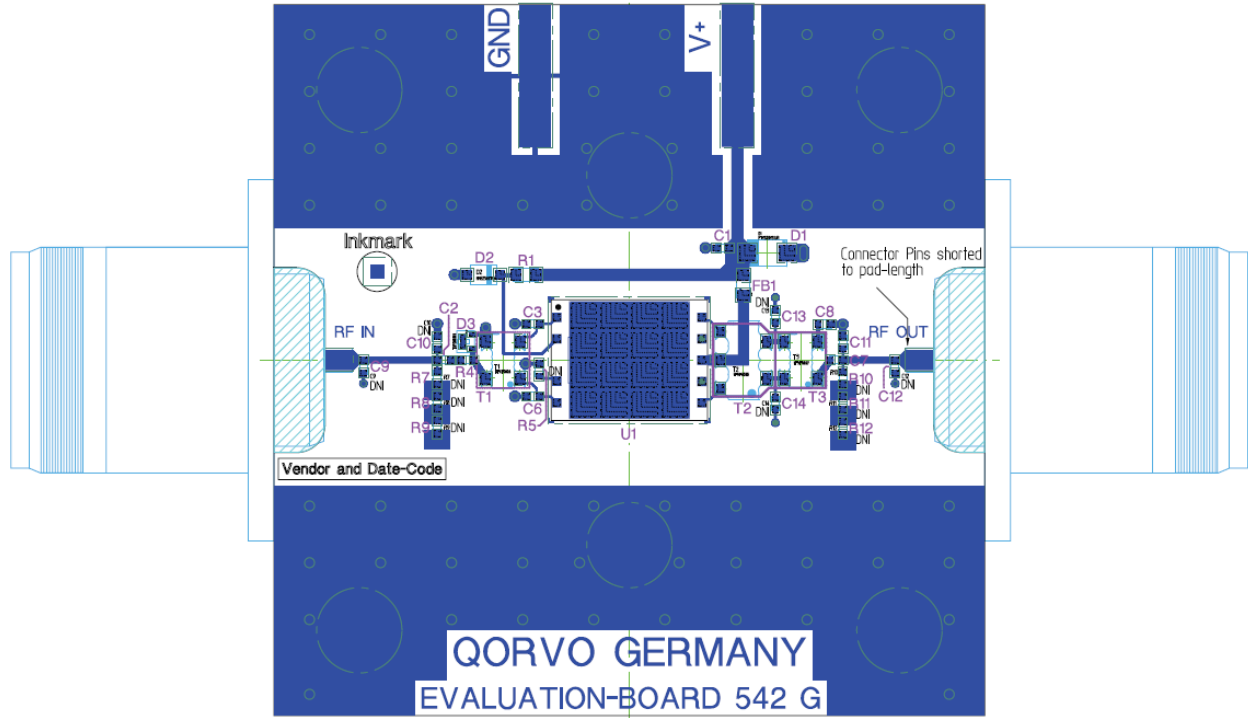

Evaluation board PCB: FR4, double sided, 1.5mm, 35um Cu

Vias are required under the backside paddle of this device for proper RF/DC grounding and thermal dissipation. A via drill diameter of 0.4mm and a minimum via wall copper plating thickness of 25um is recommended. Open vias are preferred to allow flux and gases to escape during reflow soldering and therefore to minimize voiding. Underneath this via array a heat sink with thermal grease needs to be placed which is able to dissipate the complete module DC power (up to 6.5 Watts). In any case the module backside temperature should not exceed 100 °C.

Evaluation Board Schematic

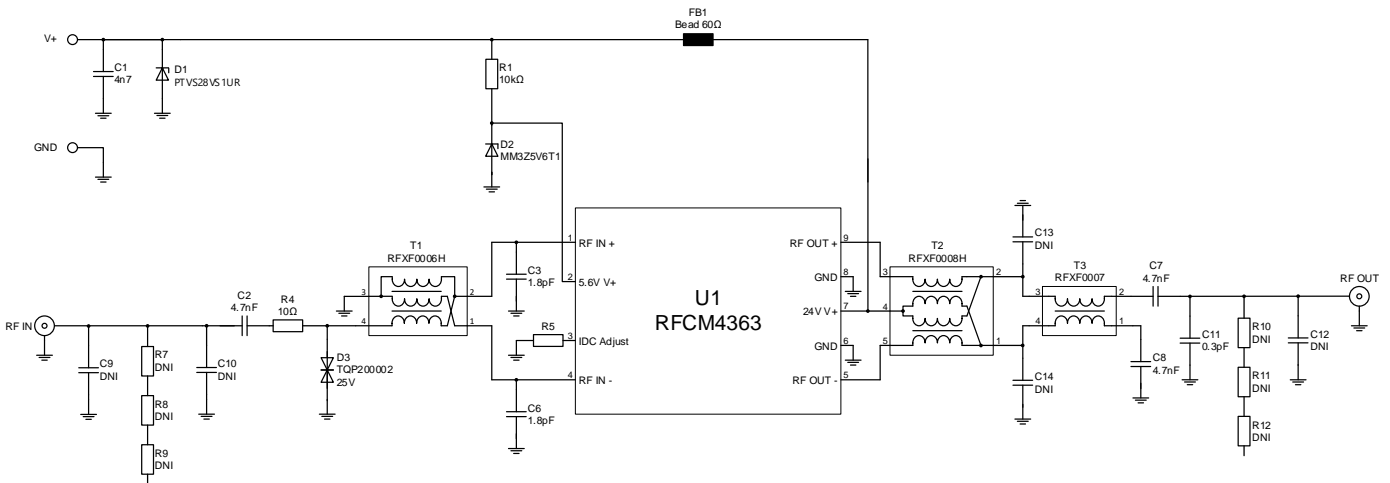

Evaluation Board Bill of Materials (BOM)

Reference Des.	Value	Description	Manuf.	Part Number
PCB		PCB RFCM4363 – EVB 542G	Qorvo	
C9, C10, C12, C13, C14	DNI	optional to improve matching in application		
C1, C2, C7, C8	4.7 nF	CAP, 0402, 10%, 50V, X7R		
C11	0.3 pF	CAP, 0402, ± 0.1 pF, 50V, C0G		
C3, C6	1.8 pF	CAP, 0402, ± 0.25 pF, 50V, C0G		
R1	10 k Ω	RES, 0603, 5%, TK100		
R4	10 Ω	RES, 0402, 1%, TK100		
R7, R8, R9, R10, R11, R12	DNI	optional to improve matching in application		
R5	See page 6	optional to set current value		
FB1	60 Ω at 100MHz	Impedance Bead	TaiyoYuden	BK 1608 HS 600
D1	28 V	Diode, TVS, PTVS28VS1UR, SOD123W	NXP	PTVS28VS1UR
D2	5.6 V	Zener Diode MM3Z5V6T1G, SOD-323	ON Semiconductor	MM3Z5V6T1G
D3	25 V	ESD Protection Diode TQP200002, TSLP3	Qorvo/ Unisem	TQP200002
T1		RFXF0006H	Qorvo	RFXF0006H
T2		RFXF0008H	Qorvo	RFXF0008H
T3		RFXF0007	Qorvo	RFXF0007
U1	DUT	RFCM4363	Qorvo	RFCM4363

Current Adjustment

The RFCM4363 can be operated over a wide range of current to provide maximum required performance with minimum current consumption. Changing the value of resistor R5 on application circuit allows a variation of the current between 200 mA and 260 mA (typ.). Within the recommended range of current between 200 mA and 260 mA gain (S21) change is less than 0.4 dB (typ.) and noise figure change is less than 0.2 dB (typ.).

Device Current vs. Resistor R5 (typical values)

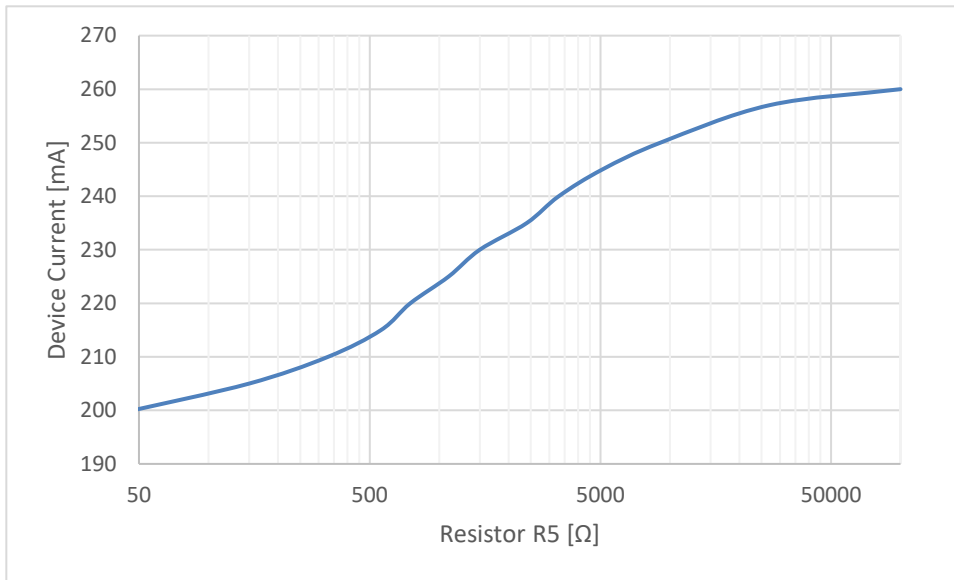

Device Current [mA] (typical)	R5 [Ω]
260	open
250	9100
240	3300
230	1500
220	750
210	330
200	47

Device Current vs. Distortion Degradation (typical values)

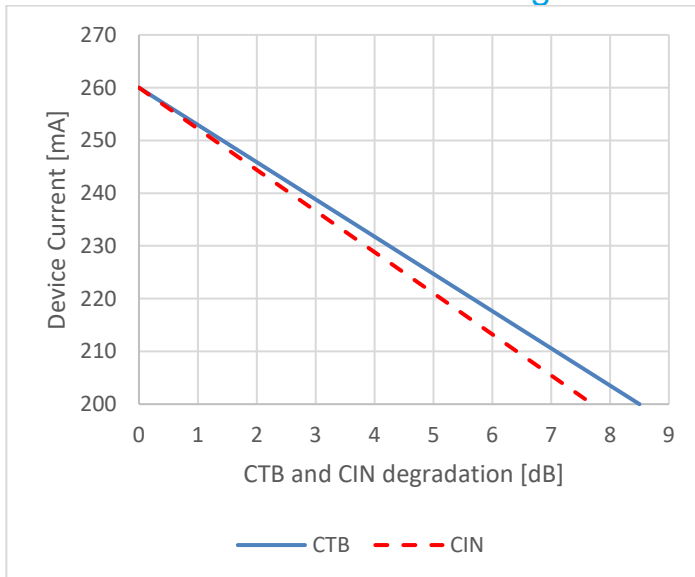

Test Condition: V+=24V, TMB=30°C, ZS=ZL=75Ω, IDC=IDC (typ.), NTSC, 79ch analog; 46 dBmV @ 547.25 MHz; 0 dB tilt, with 75 J.83/B QAM256 channels (6 dB down)

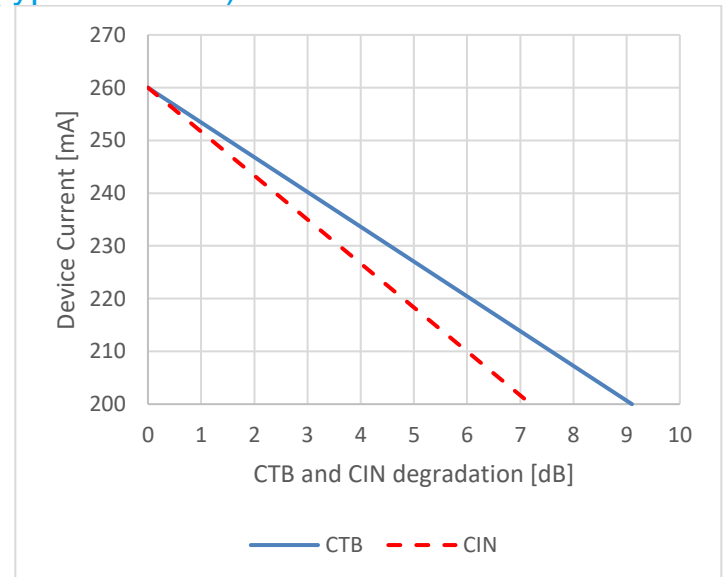

Test Condition: V+=24V, TMB=30°C, ZS=ZL=75Ω, IDC=IDC (typ.), NTSC, 79ch analog; 45 dBmV @ 547.25 MHz; 0 dB tilt, with 111 J.83/B QAM256 channels (6 dB down)

Pin Configuration

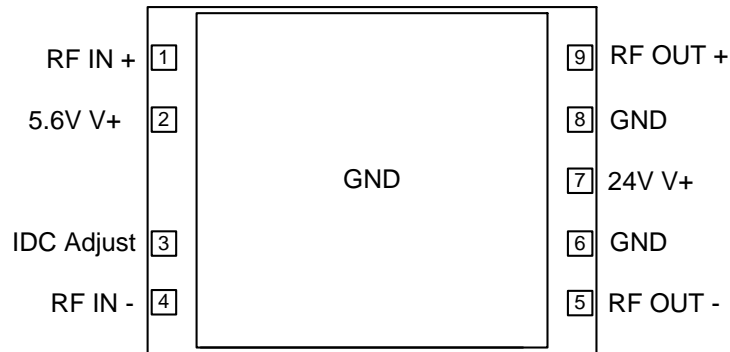

Pin Description

Pin No.	Label	Description
1	RF IN (+)	RF AMP Positive Input
2	5.6V V+	Supply Voltage 5.6V
3	IDC Adjust	Current Adjustment
4	RF IN (-)	RF AMP Negative Input
5	RF OUT (-)	RF AMP Negative Output
6	GND	Ground
7	24V V+	Supply Voltage 24V
8	GND	Ground
9	RF OUT (+)	RF AMP Positive Output

Package Outline Drawing (Dimensions in millimeters)

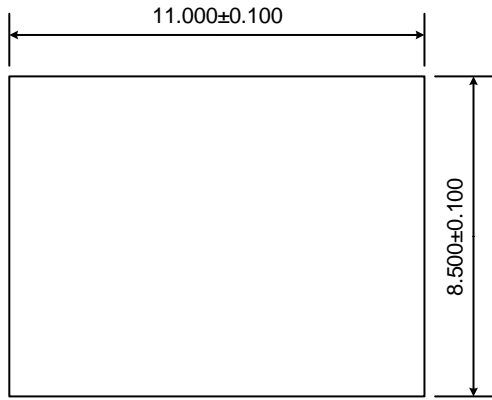

TOP VIEW

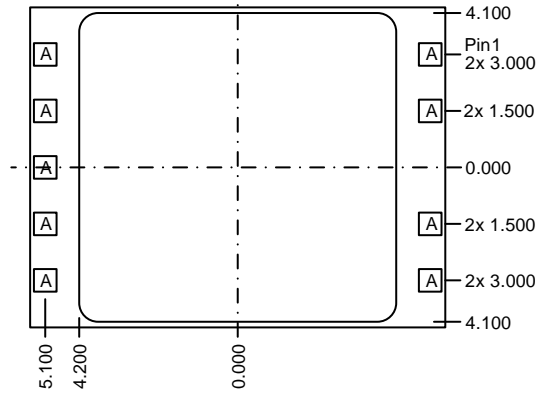

A= 0.600 x 0.600 mm

BOTTOM PIN VIEW

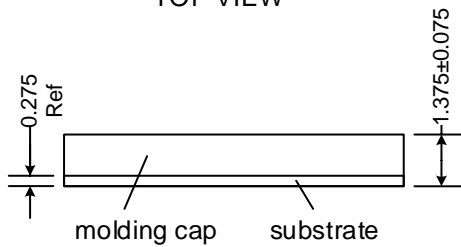

SIDE VIEW

Handling Precautions

Parameter	Rating	Standard
ESD – Human Body Model (HBM)	1B	JEDEC JS-001
ESD – Charged Device Model (CDM)	C2b	JEDEC JS-002
MSL – Moisture Sensitivity Level	Level 3	IPC/JEDEC J-STD-020



Caution!
ESD-Sensitive Device

Solderability

Compatible with both lead-free (260°C max. reflow temp.) and tin/lead (245°C max. reflow temp.) soldering processes. Solder profiles available upon request.

Contact plating: ENEPIG

RoHS Compliance

This part is compliant with 2011/65/EU RoHS directive (Restrictions on the Use of Certain Hazardous Substances in Electrical and Electronic Equipment) as amended by Directive 2015/863/EU.

This product also has the following attributes:

- Halogen Free (Chlorine, Bromine)
- Antimony Free
- TBBP-A (C₁₅H₁₂Br₄O₂) Free
- PFOS Free
- SVHC Free

Contact Information

For the latest specifications, additional product information, worldwide sales and distribution locations:

Web: www.qorvo.com

Tel: 1-844-890-8163

Email: customer.support@qorvo.com

Important Notice

The information contained herein is believed to be reliable; however, Qorvo makes no warranties regarding the information contained herein and assumes no responsibility or liability whatsoever for the use of the information contained herein. All information contained herein is subject to change without notice. Customers should obtain and verify the latest relevant information before placing orders for Qorvo products. The information contained herein or any use of such information does not grant, explicitly or implicitly, to any party any patent rights, licenses, or any other intellectual property rights, whether with regard to such information itself or anything described by such information. **THIS INFORMATION DOES NOT CONSTITUTE A WARRANTY WITH RESPECT TO THE PRODUCTS DESCRIBED HEREIN, AND QORVO HEREBY DISCLAIMS ANY AND ALL WARRANTIES WITH RESPECT TO SUCH PRODUCTS WHETHER EXPRESS OR IMPLIED BY LAW, COURSE OF DEALING, COURSE OF PERFORMANCE, USAGE OF TRADE OR OTHERWISE, INCLUDING THE IMPLIED WARRANTIES OF MERCHANTABILITY AND FITNESS FOR A PARTICULAR PURPOSE.**

Without limiting the generality of the foregoing, Qorvo products are not warranted or authorized for use as critical components in medical, life-saving, or life-sustaining applications, or other applications where a failure would reasonably be expected to cause severe personal injury or death.

Copyright 2017 © Qorvo, Inc. | Qorvo is a registered trademark of Qorvo, Inc.

Mouser Electronics

Authorized Distributor

Click to View Pricing, Inventory, Delivery & Lifecycle Information:

[Qorvo:](#)

[RFCM4363TR13](#) [RFCM4363PCBA-410](#) [RFCM4363SR](#) [RFCM4363TR7](#)