

# RFCM3316

45-1218MHZ GAAS/GAN  
POWER DOUBLER MODULE



The RFCM3316 is a Power Doubler amplifier SMD Module. The part employs GaAs pHEMT die and GaN HEMT die, has high output capability, and is operated from 45MHz to 1218MHz. It provides excellent linearity and superior return loss performance with low noise and optimal reliability.

DC current of the device can be externally adjusted for optimum distortion performance versus power consumption over a wide range of output level.

Package: 9 pin,  
9.0 mm x 8.0 mm x 1.375mm

## Features

- Excellent Linearity
- Superior Return Loss Performance
- Extremely Low Distortion
- Optimal Reliability
- Low Noise
- Unconditionally Stable Under all Terminations
- Extremely High Output Capability
- 22.5dB Min. Gain at 1218MHz
- 450mA Max. at 24VDC
- Temperature Sensing Feature

## Applications

- 45MHz to 1218MHz CATV Amplifier Systems

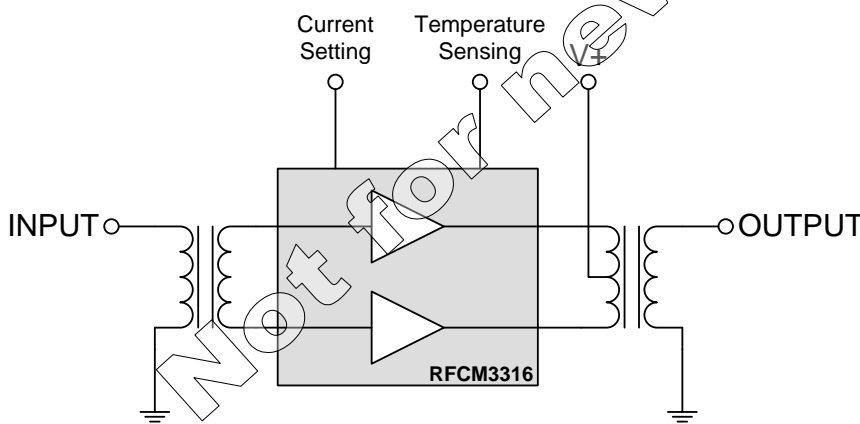

Functional Block Diagram

## Ordering Information

RFCM3316SB	Sample bag with 5 pieces
RFCM3316SQ	Sample bag with 25 pieces
RFCM3316SR	7" Reel with 100 pieces
RFCM3316TR7	7" Reel with 500 pieces
RFCM3316TR13	13" Reel with 1000 pieces
RFCM3316PCBA-410	Fully Assembled Evaluation Board

### Absolute Maximum Ratings

Parameter	Rating	Unit
RF Input Voltage (single tone; on evaluation board)	75	dBmV
DC Supply Over-Voltage (5 minutes)	30	V
Storage Temperature	-40 to +100	°C
Operating Mounting Base Temperature	-30 to +110	°C
Moisture Sensitivity Level IPC/JEDEC J-STD-20	MSL 3 @260	°C



Caution! ESD sensitive device.



RoHS status based on EU Directive 2011/65/EU

Exceeding any one or a combination of the Absolute Maximum Rating conditions may cause permanent damage to the device. Extended application of Absolute Maximum Rating conditions to the device may reduce device reliability. Specified typical performance or functional operation of the device under Absolute Maximum Rating conditions is not implied.

### Nominal Operating Parameters

Parameter	Specification			Unit	Condition
	Min	Typ	Max		
<b>General Performance</b>					<b>V+= 24V; T<sub>MB</sub>=30°C; Z<sub>S</sub>=Z<sub>L</sub>=75Ω; I<sub>DC</sub>=I<sub>DC</sub> typical</b>
Power Gain	21.0	21.5	22.0	dB	f=45MHz
	22.5	23.0	24.0	dB	f=1218MHz
Slope <sup>[1]</sup>	1.0	1.5	2.5	dB	f=45MHz to 1218MHz
Flatness of Frequency Response			1	dB	f=45MHz to 1218MHz (Peak to Valley)
Input Return Loss	20			dB	f=45MHz to 320MHz
	19			dB	f=320MHz to 640MHz
	18			dB	f=640MHz to 870MHz
	16			dB	f=870MHz to 1000MHz
	15			dB	f=1000MHz to 1218MHz
Output Return Loss	20			dB	f=45MHz to 320MHz
	19			dB	f=320MHz to 640MHz
	18			dB	f=640MHz to 870MHz
	17			dB	f=870MHz to 1000MHz
	16			dB	f=1000MHz to 1218MHz
Noise Figure		3.0	4.0	dB	f=50MHz to 1218MHz
Total Current Consumption (DC)		430	450	mA	

Parameter	Specification			Unit	Condition
	Min	Typ	Max		
<b>Distortion data 40MHz to 550MHz</b>					<b>V+= 24V; T<sub>MB</sub>=30°C; Z<sub>S</sub>=Z<sub>L</sub>=75Ω; I<sub>DC</sub>=I<sub>DC</sub> typical</b>
CTB		-73	-68	dBc	V <sub>o</sub> =61dBmV at 1000MHz, 18dB extrapolated tilt, 79 analog channels plus 75 digital channels (-6dB offset) <sup>[2][4]</sup>
XMOD		-65	-60	dBc	
CSO		-76	-70	dBc	
CIN	55	60		dB	
<b>Distortion data 40MHz to 550MHz</b>					<b>V+= 24V; T<sub>MB</sub>=30°C; Z<sub>S</sub>=Z<sub>L</sub>=75Ω; I<sub>DC</sub>=I<sub>DC</sub> typical</b>
CTB		-80		dBc	V <sub>o</sub> =60dBmV at 1218MHz, 22dB extrapolated tilt, 79 analog channels plus 111 digital channels (-6dB offset) <sup>[3][4]</sup>
XMOD		-78		dBc	
CSO		-80		dBc	
CIN		59		dB	

1. The slope is defined as the difference between the gain at the start frequency and the gain at the stop frequency.
2. 79 analog channels, NTSC frequency raster: 55.25MHz to 547.25MHz, +43dBmV to +52.4dBmV tilted output level, plus 75 digital channels, -6dB offset relative to the equivalent analog carrier.
3. 79 analog channels, NTSC frequency raster: 55.25MHz to 547.25MHz, +38dBmV to +47.4dBmV tilted output level, plus 111 digital channels, -6dB offset relative to the equivalent analog carrier.
4. Composite Second Order (CSO) - The CSO parameter (both sum and difference products) is defined by the NCTA. Composite Triple Beat (CTB) - The CTB parameter is defined by the NCTA. Cross Modulation (XMOD) - Cross modulation (XMOD) is measured at baseband (selective voltmeter method), referenced to 100% modulation of the carrier being tested. Carrier to Intermodulation Noise (CIN) - The CIN parameter is defined by ANSI/SCTE 17 (Test procedure for carrier to noise).

## RFCM3316 Current Adjustment

The RFCM3316 can be operated over a wide range of current to provide maximum required performance with minimum current consumption. Changing the value of resistor R3 on application circuit allows a variation of the current between 430mA and 330mA (typ.). Within the recommended range of current between 430mA and 370mA gain (S21) change is less than 0.2dB and noise figure change is less than 0.1dB.

### Current versus Resistor R3 (typical values)

Device Current [mA], typical	R3 [ $\Omega$ ]
	$V_{+}=24V; T_{MB}=30^{\circ}C;$ $Z_S=Z_L=75\Omega$
430	1500
410	1400
390	1300
370	1240
350	1150
330	1050

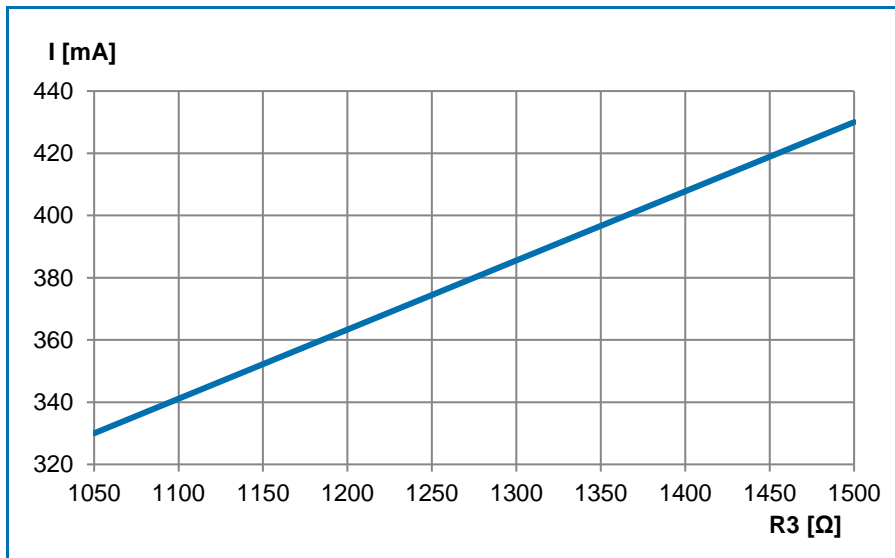

### Device Current versus Distortion Degradation (typical values)

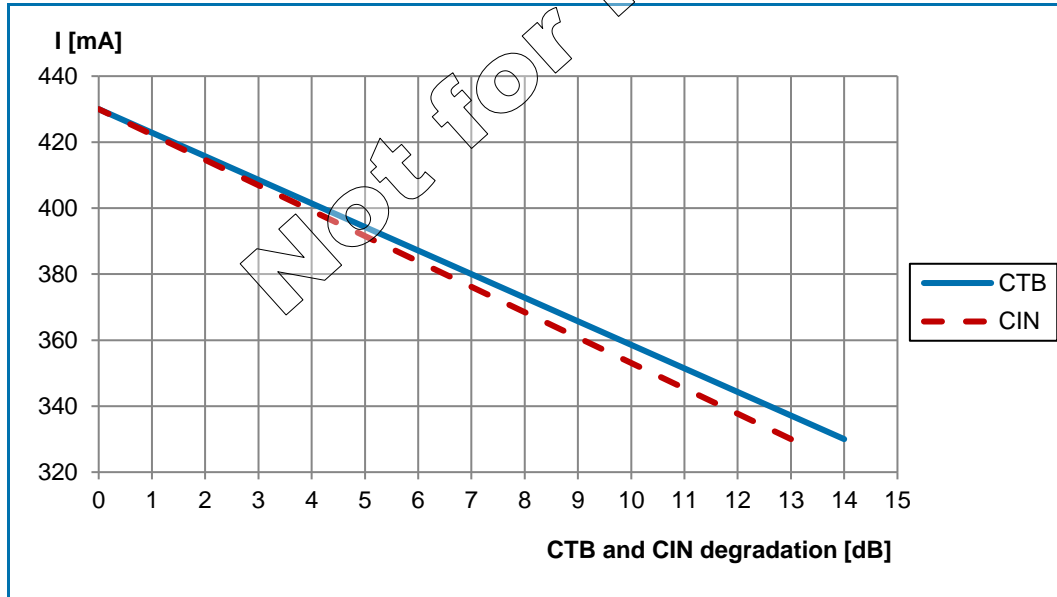

**Test condition:**  $V_{+} = 24V$ ;  $T_{MB} = 30^{\circ}C$ ;  $Z_S = Z_L = 75\Omega$ ;  $V_O = 61dBmV$  at 1000MHz, 18dB extrapolated tilt, 79 analog channels plus 75 digital channels (-6dB offset)

### RFCM3316 Temperature Sensing Feature

The RFCM3316 provides an internal NTC resistor for temperature sensing. This resistor is located right next to the output transistor stage. Within the application circuit the NTC is built in a voltage divider. The output voltage of the voltage divider ( $V_t$ ) can be correlated to the module backside temperature.

### Module Backside Temperature versus $V_t$ (typical values)

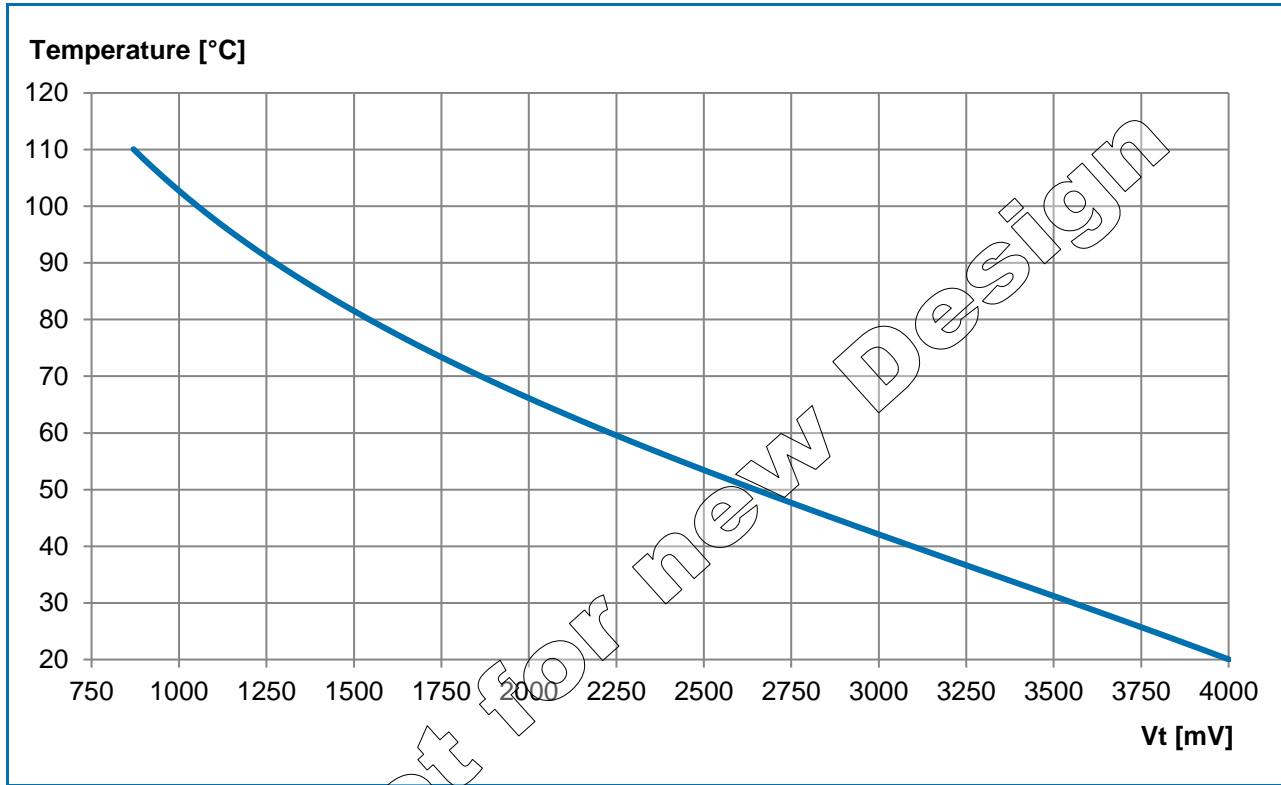

### Evaluation Board Schematic

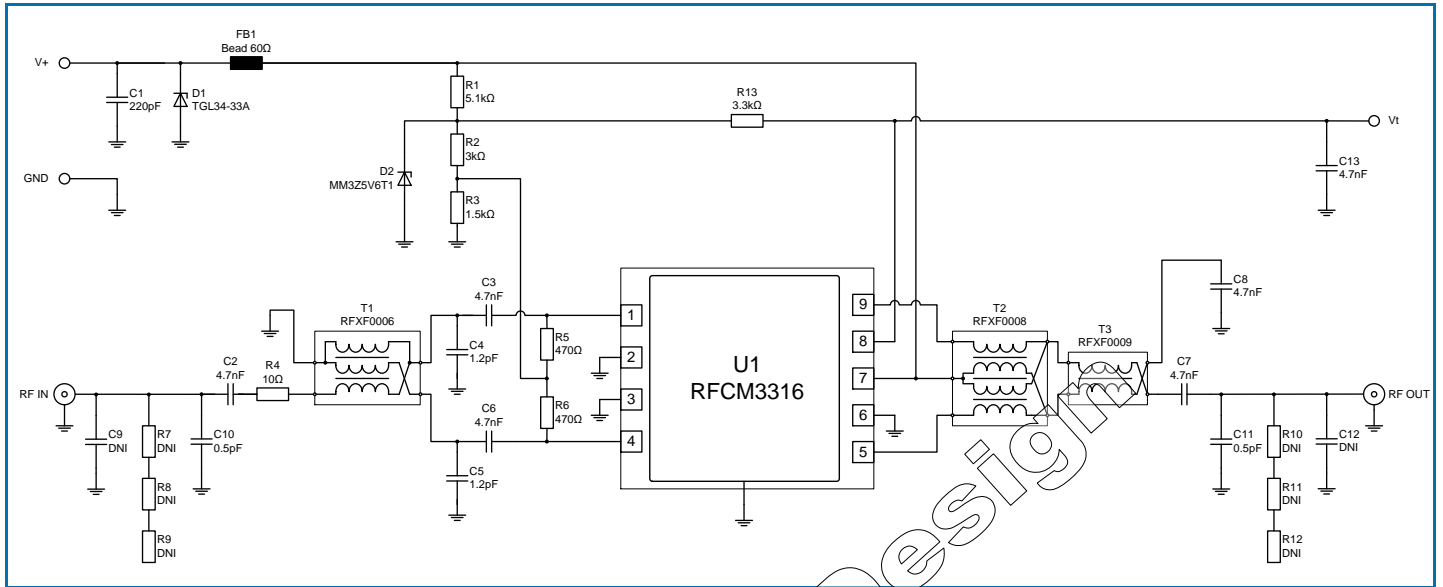

### Evaluation Board Assembly Drawing

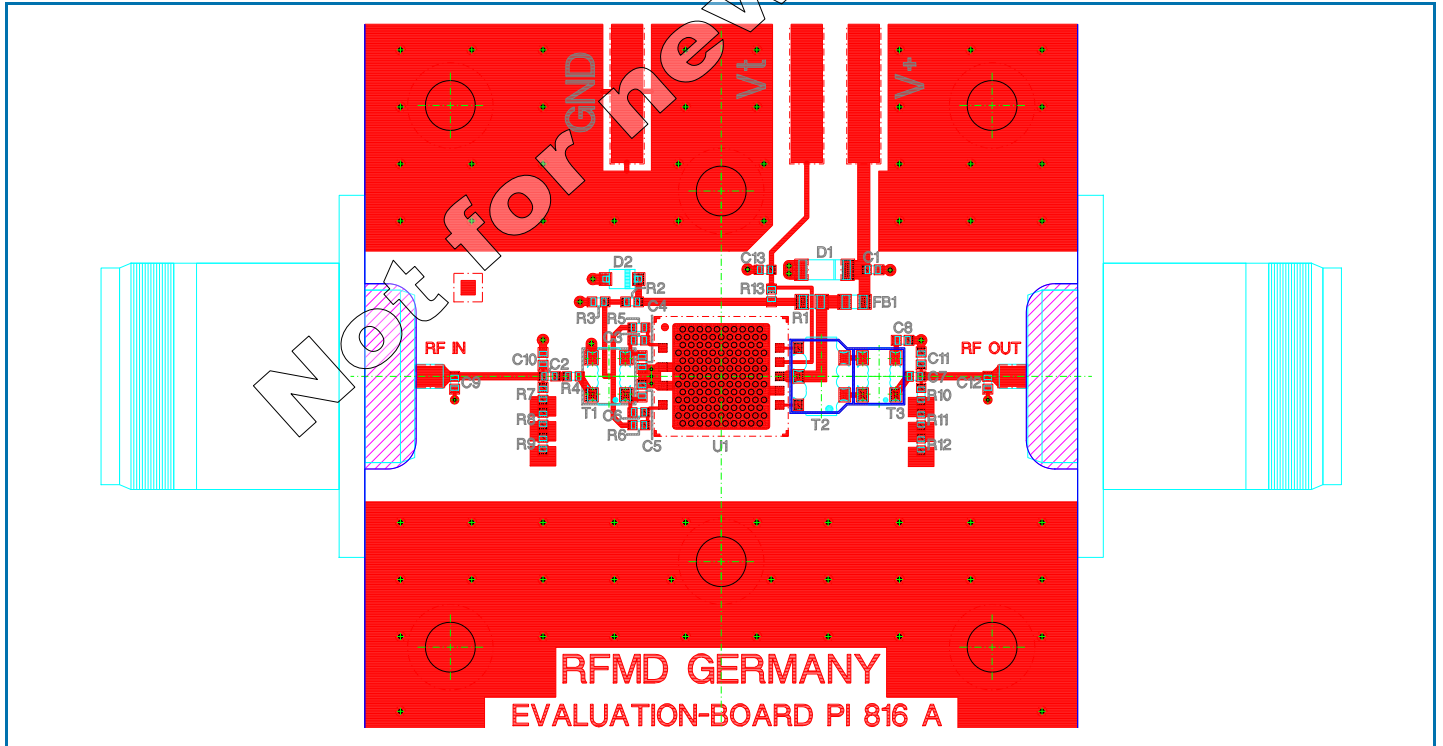

**Note:** The ground plane of the RFCM3316 module should be soldered onto a board equipped with as many thermal vias as possible. Underneath this thermal via array a heat sink with thermal grease needs to be placed which is able to dissipate the complete module DC power (up to 10.4 Watts). In any case the module backside temperature should not exceed 110°C.

### Evaluation Board Bill of Materials (BOM)

Component Type	Value	Qty	Designator	Comment
PCB	Evaluation-Board PI816A	1		
Capacitor	220pF	1	C1	
Capacitor	4.7nF	6	C2, C3, C6, C7, C8, C13	
Capacitor	1.2pF	2	C4, C5	
Capacitor	DNI	4	C9, C12	Optional to improve matching in application
Capacitor	0.5pF	2	C10, C11	Optional to improve matching in application
Resistor	5.1kΩ	1	R1	
Resistor	3kΩ	1	R2	
Resistor	1.5kΩ	1	R3	
Resistor	10Ω	1	R4	
Resistor	470Ω	2	R5, R6	
Resistor	DNI	6	R7-R12	Optional to improve matching in application
Resistor	3.3kΩ	1	R13	
Impedance Bead	60Ω @ 100MHz	1	FB1	
Transient Voltage Suppressor Diode	TGL34-33A	1	D1	
Zener Diode	MM3Z5V6T1G	1	D2	
Transformer	RFXF0006	1	T1	
Transformer	RFXF0008	1	T2	
Transformer	RFXF0009	1	T3	
DUT	RFCM3316	1	U1	

### Pin Out

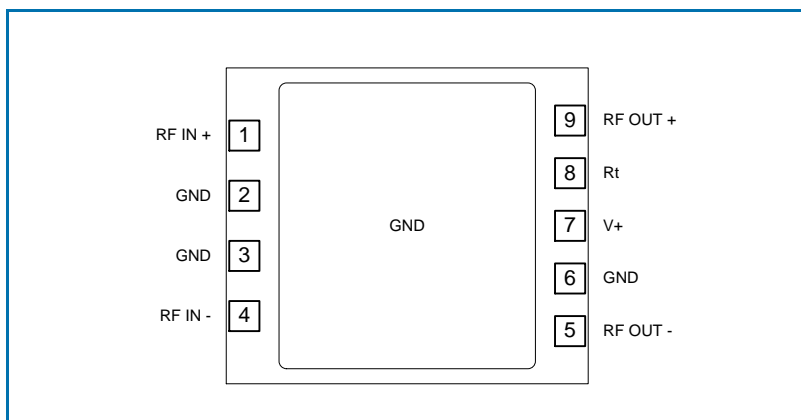



### Pin Names and Descriptions

Pin	Name	Description
1	RF IN +	RF AMP Positive Input
2, 3, 6	GND	Ground pins
4	RF IN -	RF AMP Negative Input
5	RF OUT -	RF AMP Negative Output
7	V+	Supply Voltage, +24V
8	Rt	NTC Output for Temperature Sensing
9	RF OUT +	RF AMP Positive Output

### Package Outline and Branding Drawing (Dimensions in millimeters)

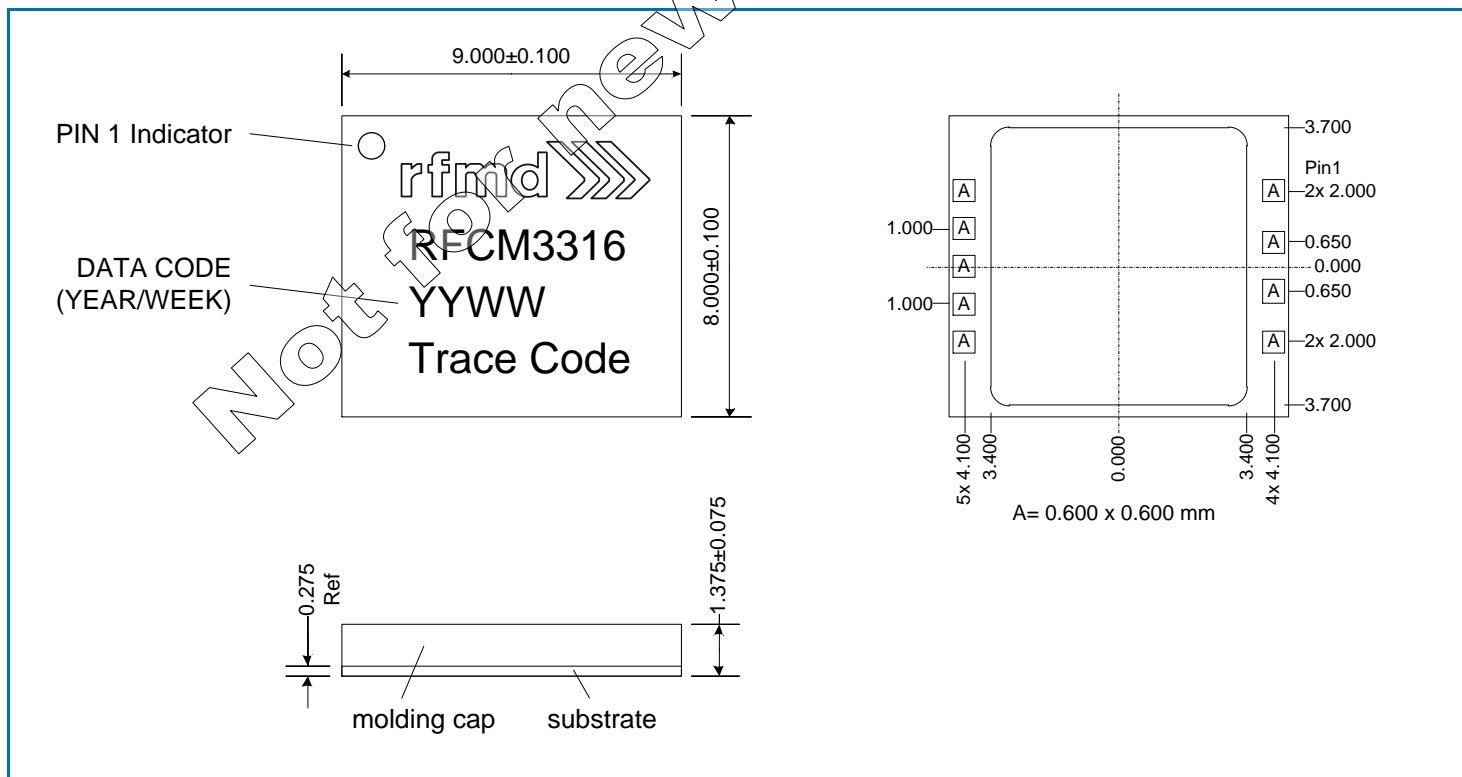

# Mouser Electronics

Authorized Distributor

Click to View Pricing, Inventory, Delivery & Lifecycle Information:

[Qorvo:](#)

[RFCM3316](#) [RFCM3316SR](#) [RFCM3316PCBA-410](#)