

## Product Overview

Qorvo's QPX0004D is a compact I/Q mixer in die form operating over the 24 to 34 GHz bandwidth that can be configured as an image reject mixer, a single sideband upconverter, or a QPSK modulator/demodulator. The QPX0004D utilizes two double balanced mixer cells and a 90° hybrid on the LO port. An external 90° hybrid on the IF port is required to complete the image rejection or sideband suppression. The QPX0004D is a much smaller alternative to higher cost hybrid I/Q Mixers and single sideband upconverter assemblies.

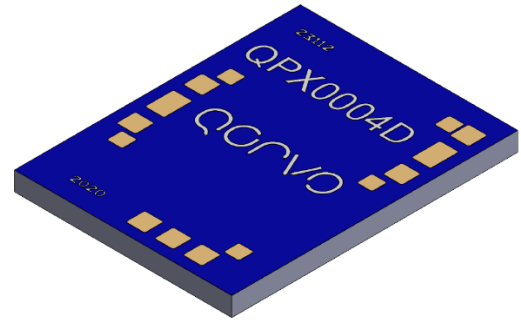

## Functional Block Diagram

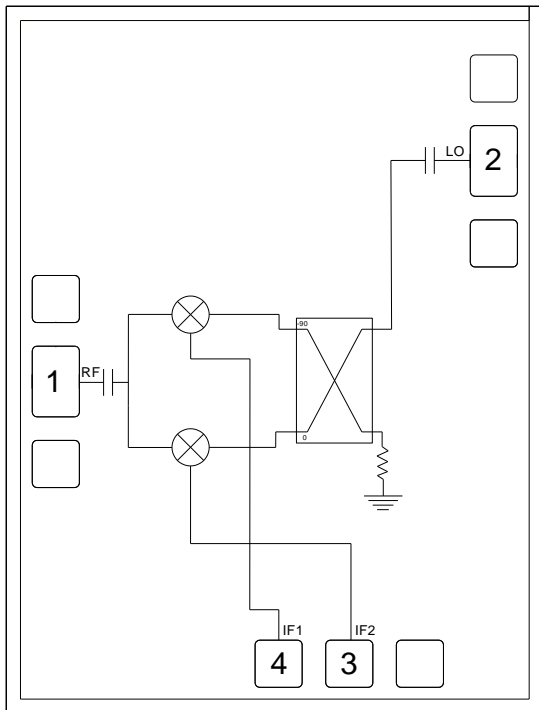

## Key Features

- I, Q outputs
- RF, LO Frequency Range: 24 to 34 GHz
- IF Frequency Range: DC – 7 GHz
- Low conversion loss of 9 dB at 28 GHz
- High image rejection of 25 dB
- High LO/RF isolation > 40 dB at 28 GHz
- Small die size

*Performance is typical across frequency. Please reference electrical specification table and data plots for more details.*

## Applications

- Image reject downconversion
- Single-sideband modulation
- Low noise receiver systems
- Phase detection
- QPSK modulation/demodulation

## Ordering Information

Part No.	Description
QPX0004D	50 pcs gel pack

## Absolute Maximum Ratings

Parameter	Rating
LO, RF, or IF power, CW, 25 °C	+25 dBm
Channel Temperature, T <sub>ch</sub>	150 °C
Operating Temperature	-55 to 85 °C
Storage Temperature	-55 to 150 °C

Exceeding any one or a combination of the Absolute Maximum Rating conditions may cause permanent damage to the device. Extended application of Absolute Maximum Rating conditions to the device may reduce device reliability.

## Recommended Operating Conditions

Parameter	Min	Typ.	Max	Units
LO Drive Power	+11	+15	+21	dBm
RF input Power (downconversion)			+17	dBm
IF Input Power (upconversion)			+17	dBm
Temperature Range	-55	+25	+85	°C

Electrical specifications are measured at specified test conditions. Specifications are not guaranteed over all recommended operating conditions.

## Electrical Specifications

Test conditions unless otherwise noted: 25 °C, IF = 100 MHz USB, LO = +15 dBm

Parameter	Min	Typ.	Max	Units
RF, LO Operational Frequency Range	24	–	34	GHz
IF Frequency Range	DC	–	7	GHz
Conversion Gain (with external 90° hybrid)	-10.7	-9	–	dB
Image Rejection (with external 90° hybrid)	–	15	–	dB
LO to RF Isolation	–	30	–	dB
LO to IF Isolation	–	24	–	dB
Input Power (P <sub>1dB</sub> )	–	+11	–	dBm
Input IP3	–	+19	–	dBm

Typical Performance – Data Taken as IRM with External IF Hybrid, IF=100 MHz USB

Conversion Gain vs. Temperature

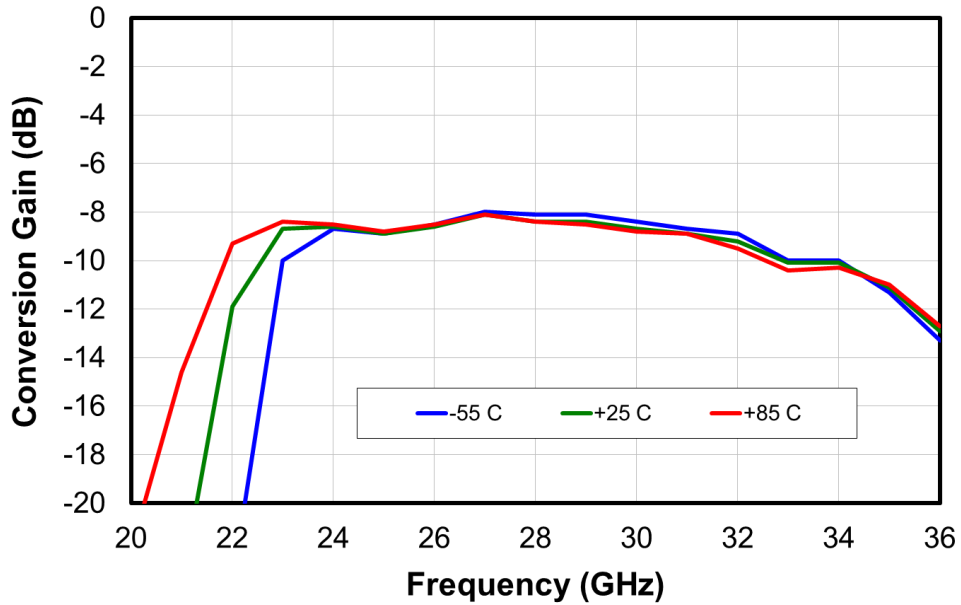

Conversion Gain vs. LO Drive

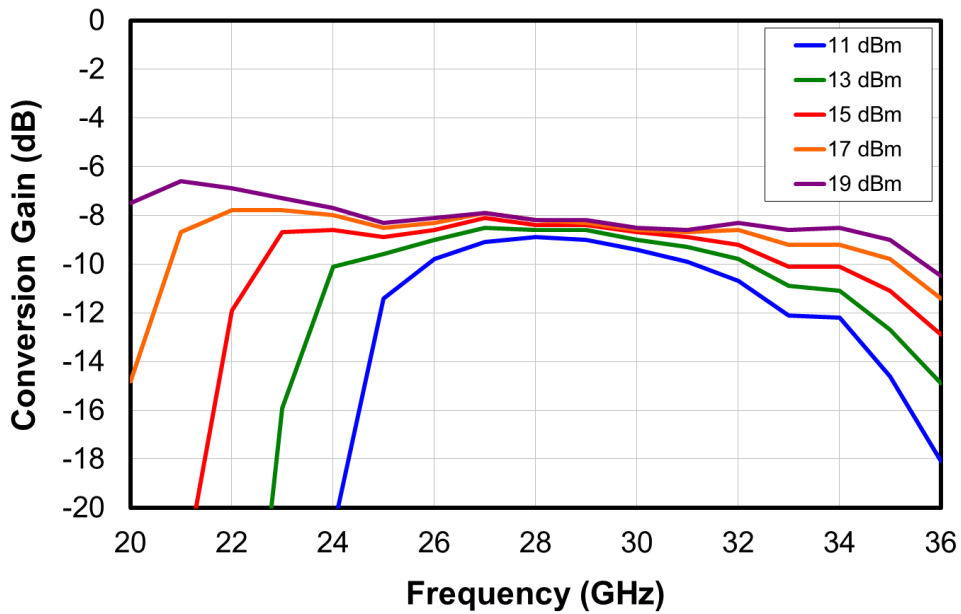

Typical Performance – Data Taken as IRM with External IF Hybrid, IF=100 MHz USB

Image Rejection vs. Temperature

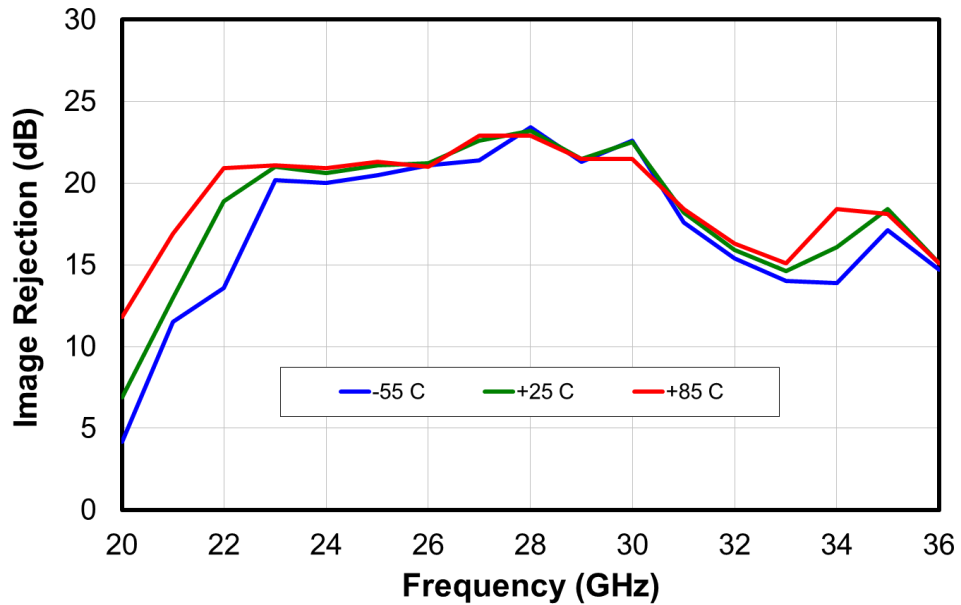

Input P1dB vs. Temperature

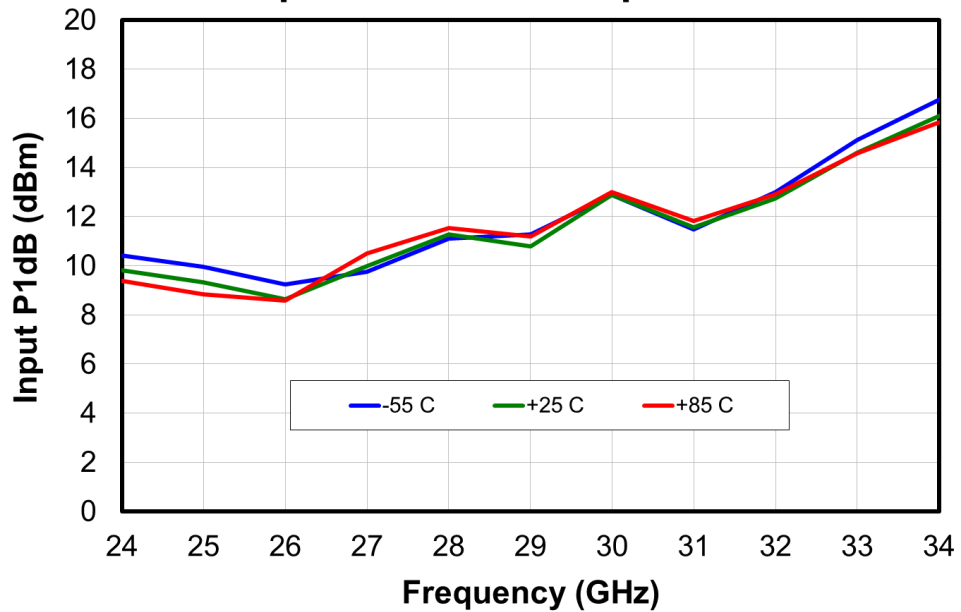

Typical Performance – Data Taken as IRM with External IF Hybrid, IF=100 MHz USB

Input IP3 vs. Temperature

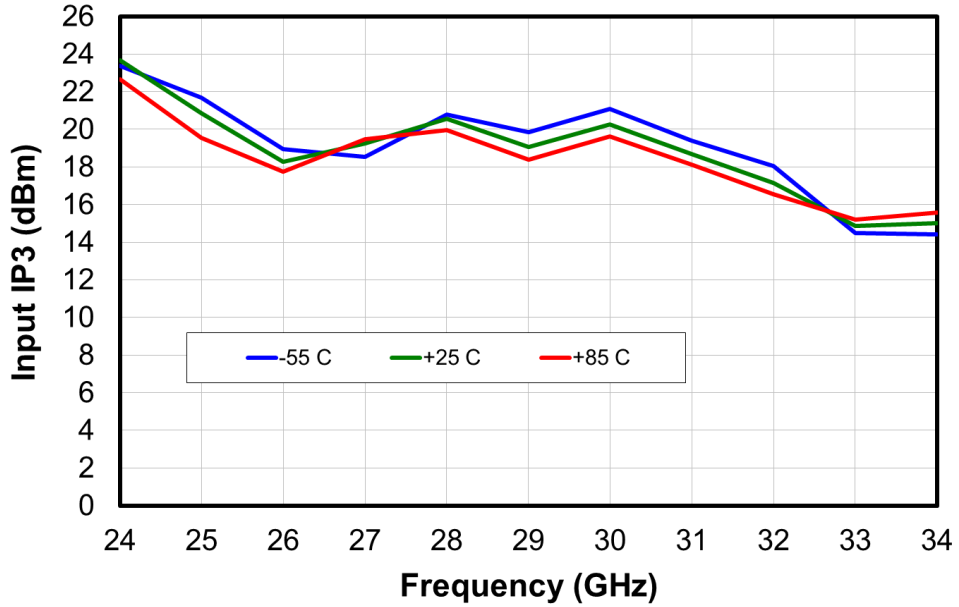

Input IP3 vs. LO Drive Level

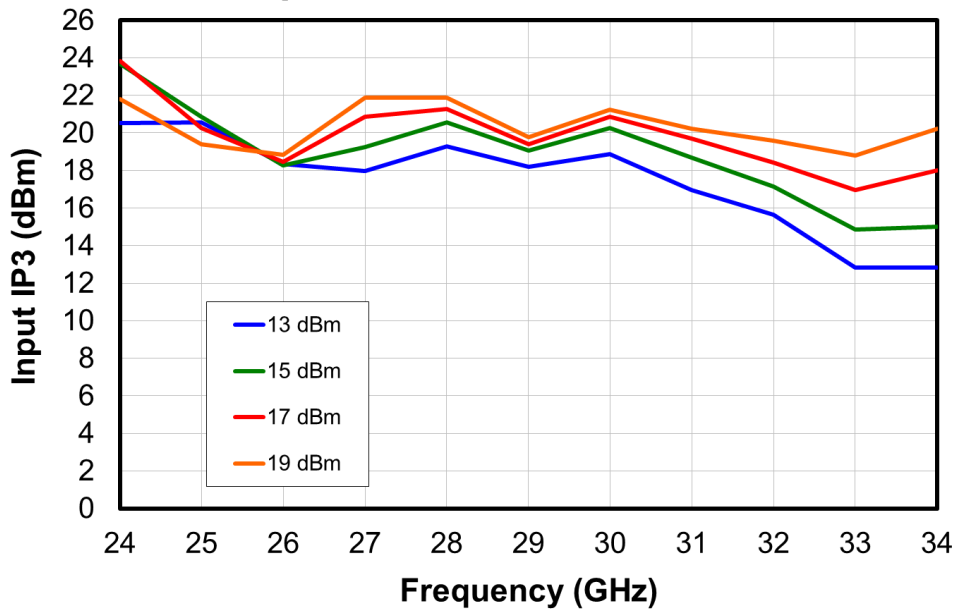

Typical Performance – Data Taken as Upconverter with External IF Hybrid, IF=950 MHz USB

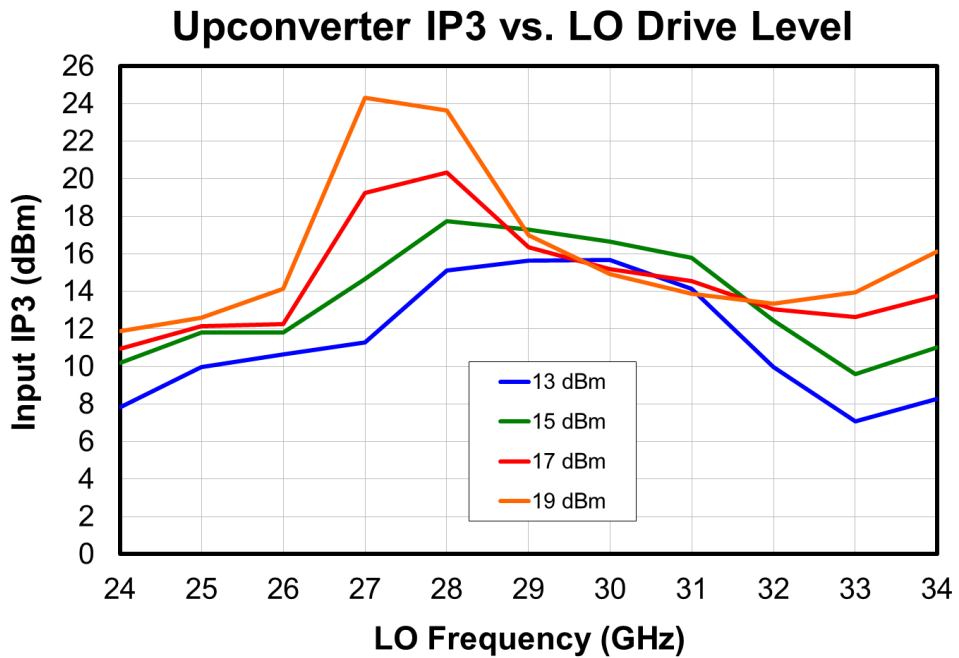
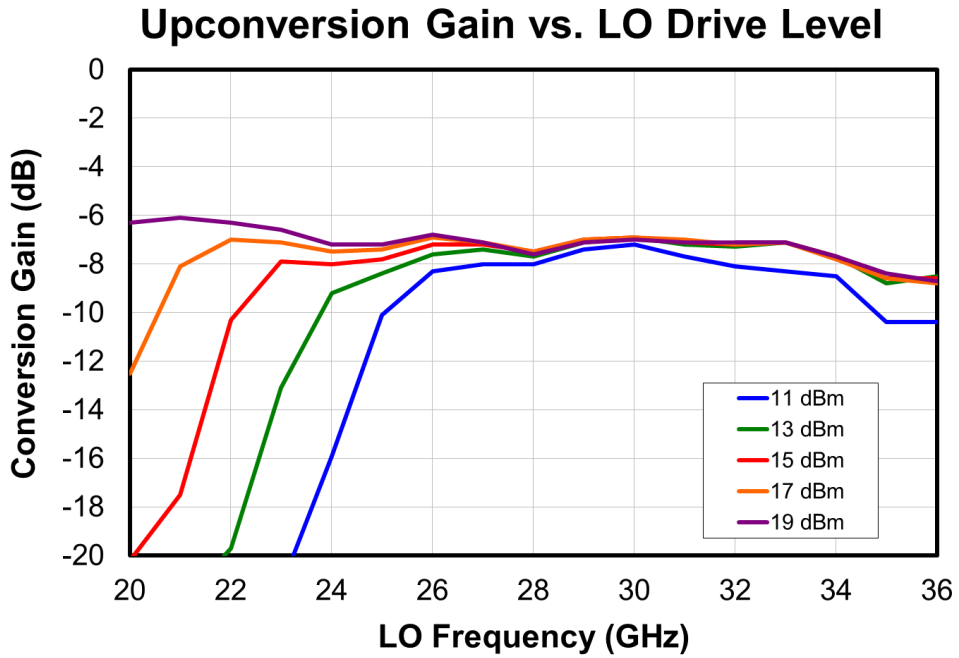

Typical Performance

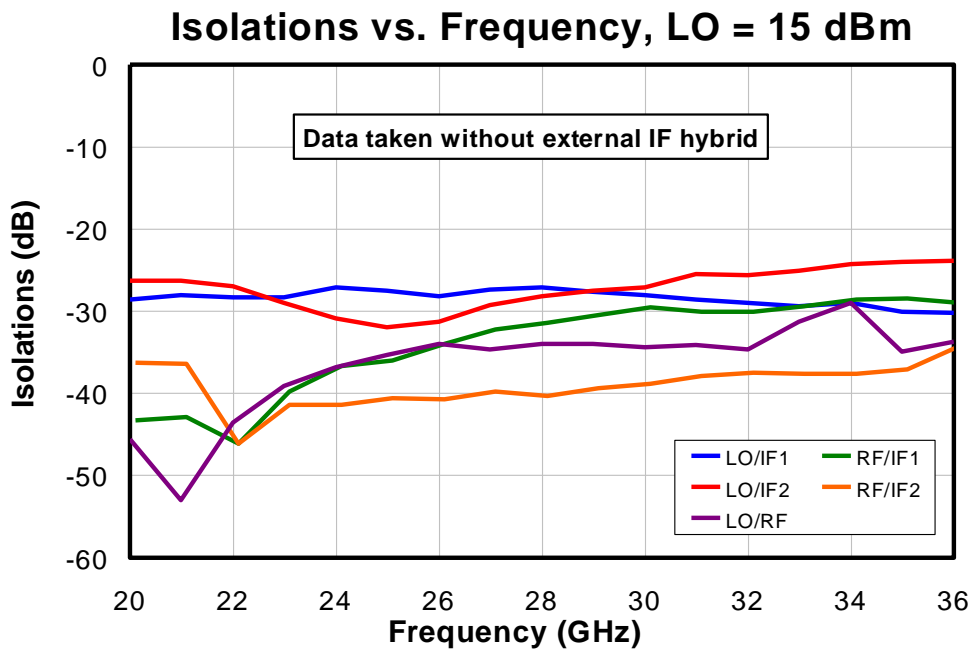
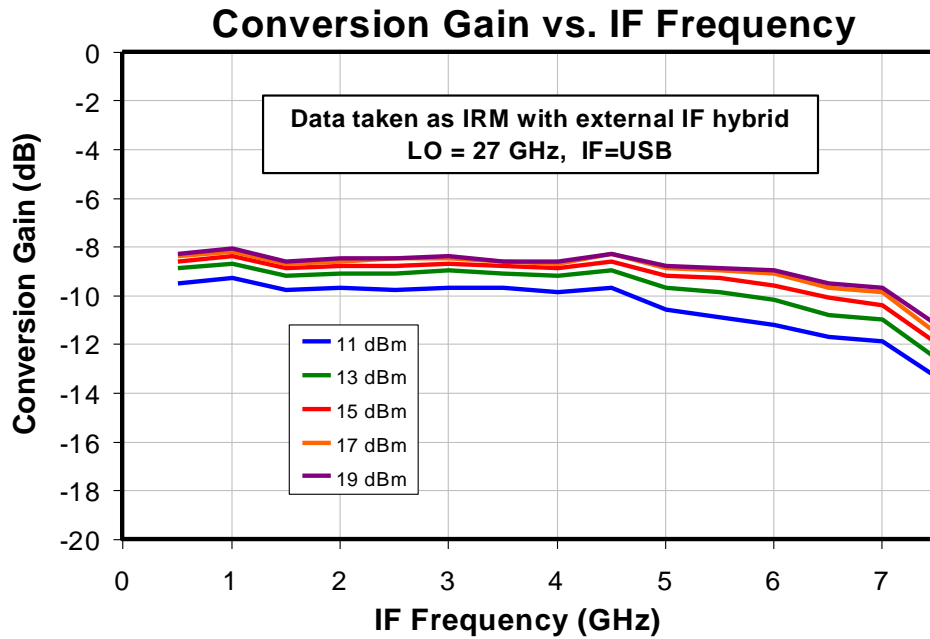

## Thermal and Reliability Information

Parameter	Test Conditions	Value	Units
Thermal Resistance ( $\theta_{JC}$ ) <sup>(1)</sup>	$T_{BASE} = 85\text{ }^{\circ}\text{C}$ , CW, Frequency = 28 GHz, LO $P_{IN} = 17\text{ dBm}$ (0.05 W), $P_{DISS} = 0.05\text{ W}$	400	$^{\circ}\text{C/W}$
Channel Temperature ( $T_{CH}$ ) <sup>(1)</sup>		105	$^{\circ}\text{C}$
Median Lifetime ( $T_M$ )		4.0E6	Hrs

Notes:

1. Measured to the back of the die.

## Spur Performance

mRF	nLO				
	0	1	2	3	4
0	x	-5			
1	23	0	37		
2		55	47	57	
3				62	
4					

RF = 28.1 GHz, -10 dBm

LO = 28 GHz, +15 dBm

All values in dBc below IF output power level (1RF – 1LO)

Data taken as downconverter with no IF hybrid



Mechanical Information

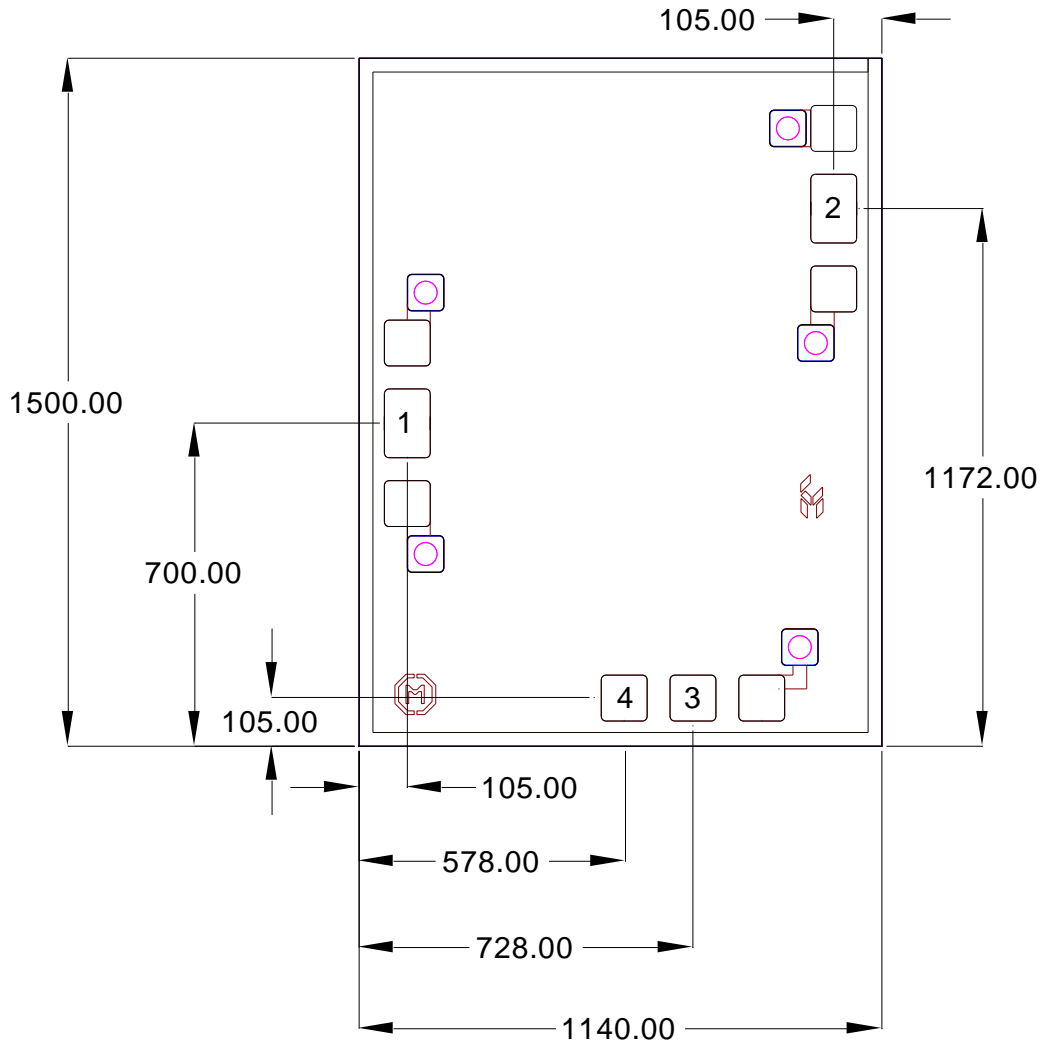

Notes:

1. All dimensions in microns.
2. No connection required for unlabeled grounds
3. Backside is RF and DC ground.
4. Backside and bond pad metal: Gold.
5. Die is 100 um thick.
6. Bond pads (1) and (2) are 100 x 150 um, bond pads (3) and (4) are 100 x 100 um.

## Pin Diagram

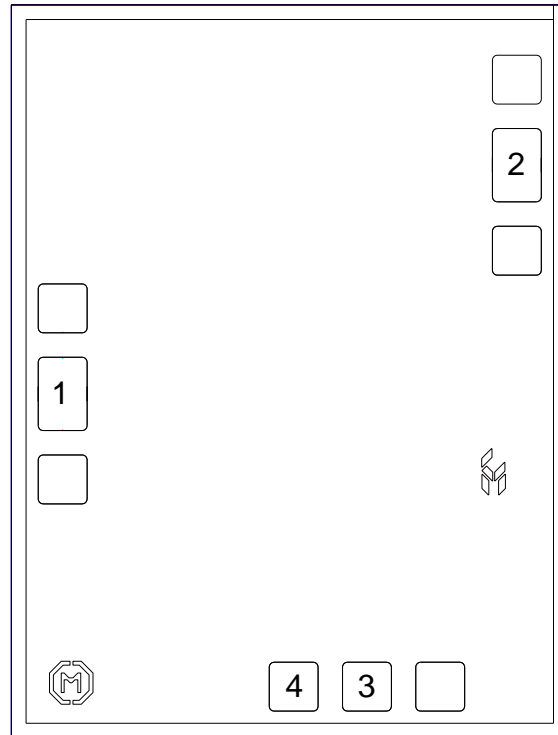

## Bond Pad Description

Pad No.	Symbol	Pad Size (um)	Description
1	RF	100 x 150	This pin is AC coupled and matched to 50 Ohms.
2	LO	100 x 150	This pin is AC coupled and matched to 50 Ohms.
3, 4	IF2, IF1	100 x 100	These pins are DC coupled. For applications not requiring operation to DC, these ports should be DC blocked externally using a series capacitor whose value has been chosen to pass the necessary IF frequency range. For operation to DC, these pins must not source or sink more than 16 mA of current or part non-function or part failure may result.
Backside	Ground		Connect to RF / DC ground

**Assembly Guidelines**

The backside of the QPX0004D is RF ground. Die attach should be accomplished with electrically and thermally conductive epoxy only. Eutectic attach is not recommended. Standard assembly procedures should be followed for high frequency devices. The top surface of the semiconductor should be made planar to the adjacent RF transmission lines.

RF connections should be made as short as possible to reduce the inductive effect of the bond wire. Use of a 0.8 mil thermosonic wedge bonding is highly recommended as the loop height will be minimized.

The semiconductor is 100  $\mu\text{m}$  thick and should be handled by the sides of the die or with a custom collet. Do not make contact directly with the die surface as this will damage the monolithic circuitry. Handle with care.

**Assembly Diagram**

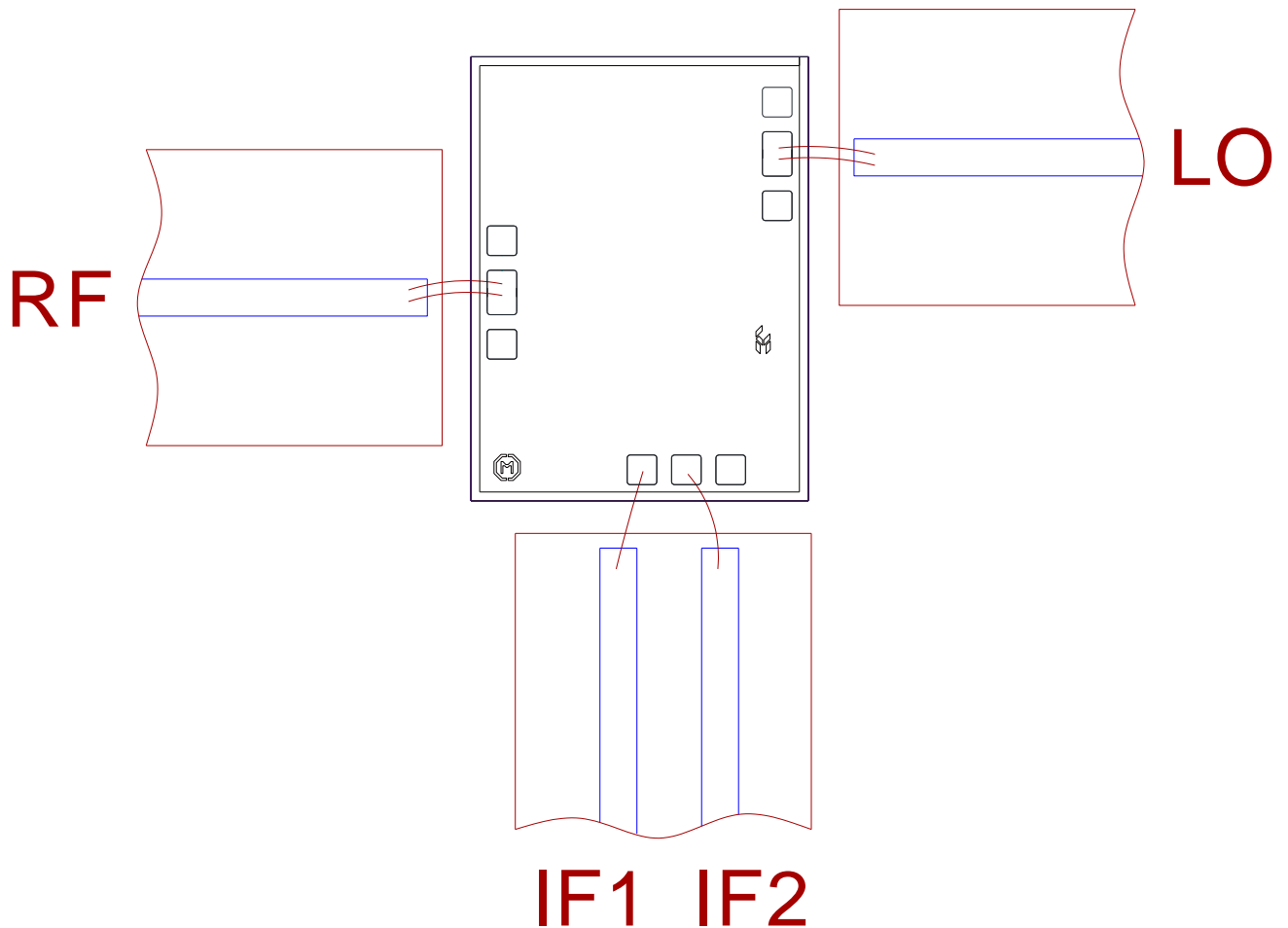

## Handling Precautions

Parameter	Rating	Standard
ESD – Human Body Model (HBM)	Class 1A	ESDA / JEDEC JS-001-2012
MSL – Convection Reflow 235 °C	N/A	JEDEC standard IPC/JEDEC J-STD-020



Caution!  
ESD-Sensitive Device

## RoHS Compliance

This part is compliant with 2011/65/EU RoHS directive (Restrictions on the Use of Certain Hazardous Substances in Electrical and Electronic Equipment) as amended by Directive 2015/863/EU.

This product also has the following attributes:

- Lead Free
- Halogen Free (Chlorine, Bromine)
- Antimony Free
- TBBP-A (C<sub>15</sub>H<sub>12</sub>Br<sub>4</sub>O<sub>2</sub>) Free
- PFOS Free
- SVHC Free

## Contact Information

For the latest specifications, additional product information, worldwide sales and distribution locations:

**Web:** [www.qorvo.com](http://www.qorvo.com)

**Tel:** 1-844-890-8163

**Email:** [customer.support@qorvo.com](mailto:customer.support@qorvo.com)

## Important Notice

The information contained herein is believed to be reliable; however, Qorvo makes no warranties regarding the information contained herein and assumes no responsibility or liability whatsoever for the use of the information contained herein. All information contained herein is subject to change without notice. Customers should obtain and verify the latest relevant information before placing orders for Qorvo products. The information contained herein or any use of such information does not grant, explicitly or implicitly, to any party any patent rights, licenses, or any other intellectual property rights, whether with regard to such information itself or anything described by such information. **THIS INFORMATION DOES NOT CONSTITUTE A WARRANTY WITH RESPECT TO THE PRODUCTS DESCRIBED HEREIN, AND QORVO HEREBY DISCLAIMS ANY AND ALL WARRANTIES WITH RESPECT TO SUCH PRODUCTS WHETHER EXPRESS OR IMPLIED BY LAW, COURSE OF DEALING, COURSE OF PERFORMANCE, USAGE OF TRADE OR OTHERWISE, INCLUDING THE IMPLIED WARRANTIES OF MERCHANTABILITY AND FITNESS FOR A PARTICULAR PURPOSE.**

Without limiting the generality of the foregoing, Qorvo products are not warranted or authorized for use as critical components in medical, life-saving, or life-sustaining applications, or other applications where a failure would reasonably be expected to cause severe personal injury or death.

Copyright 2020 © Qorvo, Inc. | Qorvo is a registered trademark of Qorvo, Inc.

# Mouser Electronics

Authorized Distributor

Click to View Pricing, Inventory, Delivery & Lifecycle Information:

[Qorvo:](#)

[QPX0004D](#)