

### Product Overview

The Qorvo QPD1029L is a 1500 W ( $P_{3dB}$ ) discrete GaN on SiC HEMT which operates from 1.2 to 1.4 GHz. Input pre-match within the package results in ease of external board match and saves board space. The device is in an industry standard air cavity package and is ideally suited for radar. The device can support both CW and pulsed operations.

RoHS compliant

Evaluation boards are available upon request.



4-lead NI-1230 Package (Eared)

### Functional Block Diagram

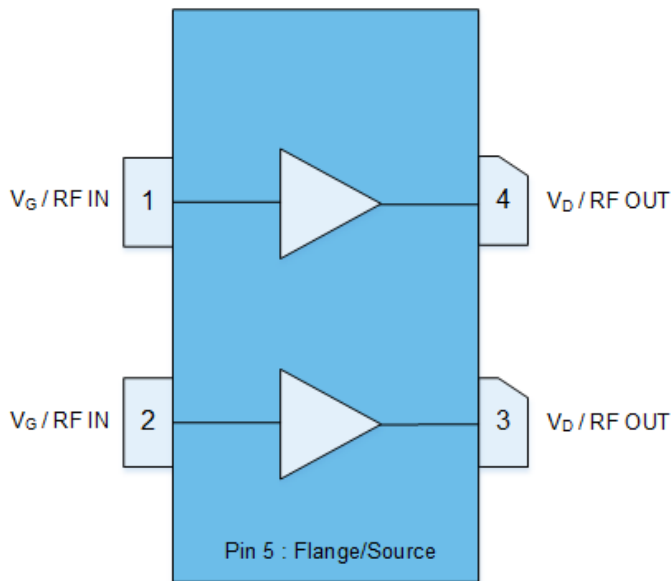

### Key Features

- Frequency: 1.2 to 1.4 GHz
- Output Power ( $P_{3dB}$ )<sup>1</sup>: 1500 W
- Linear Gain<sup>1</sup>: 21.3 dB
- Typical PAE<sub>3dB</sub><sup>1</sup>: 75%
- Operating Voltage: 65 V
- CW and Pulse capable

Note 1: @ 1.3 GHz Load Pull

### Applications

- L-Band radar-amplifier application

### Ordering info

Part No.	Description
QPD1029L	1.2 – 1.4 GHz Transistor (18 pcs in tray)
QPD1029LEVB4	1.2 – 1.4 GHz Evaluation Board



### Absolute Maximum Ratings <sup>1, 2, 3</sup>

Parameter	Rating	Units
Breakdown Voltage, $BV_{DG}$	225	V
Gate Voltage Range, $V_G$	-7 to +2	V
Drain Current, $I_{D_{MAX}}$	142	A
Gate Current Range, $I_G$	See pg. 12	mA
Power Dissipation, Pulsed, $P_{DISS}^2$	1728	W
RF Input Power, Pulsed, $P_{IN}^3$	46.2	dBm
Mounting Temperature (30 Seconds)	320	°C
Storage Temperature	-65 to +150	°C

Notes:

1. Operation of this device outside the parameter ranges given above may cause permanent damage
2. Pulsed, 300us PW, 10% DC, Package base at 85 °C
3. Pulsed, 300us PW, 10% DC, T = 25 °C

### Recommended Operating Conditions <sup>1, 2, 3, 4</sup>

Parameter	Min	Typ	Max	Units
Operating Temp. Range	-40	+25	+85	°C
Drain Voltage Range, $V_D$	-	+65	+70	V
Drain Bias Current, $I_{DQ}$		1.5		A
Drain Current, $I_D^4$	-	45	-	A
Gate Voltage, $V_G^3$	-	-2.8	-	V
Power Dissipation ( $P_D$ ) <sup>2,4</sup>	-	-	865	W
Power Dissipation ( $P_D$ ), CW <sup>2</sup>	-	-	467	W

Notes:

1. Electrical performance is measured under conditions noted in the electrical specifications table. Specifications are not guaranteed over all recommended operating conditions
2. Package base at 85 °C
3. To be adjusted to desired  $I_{DQ}$
4. Pulsed, 300us PW, 10% DC

### Measured Load Pull Performance – 65V Power Tuned <sup>1, 2</sup>

Parameter	Typical Values			Units
	1.2	1.3	1.4	
Frequency, F	1.2	1.3	1.4	GHz
Output Power at 3dB compression, $P_{3dB}$	60.1	60.1	59.9	dBm
Drain Efficiency at 3dB compression, $DEff_{3dB}$	63.7	62.5	64.4	%
Gain at 3dB compression, $G_{3dB}$	17.3	16.5	16.9	dB

Notes:

1. Test conditions unless otherwise noted:  $T_A = 25\text{ °C}$ ,  $V_D = 65\text{ V}$ ,  $I_{DQ} = 750\text{ mA}$  (half device)
2. Pulsed, 100 us Pulse Width, 10% Duty Cycle.

### Measured Load Pull Performance – 65V Efficiency Tuned <sup>1, 2</sup>

Parameter	Typical Values			Units
	1.2	1.3	1.4	
Frequency, F	1.2	1.3	1.4	GHz
Output Power at 3dB compression, $P_{3dB}$	58.5	58.5	58.5	dBm
Drain Efficiency at 3dB compression, $D\text{ Eff}_{3dB}$	78.7	76.4	76.4	%
Gain at 3dB compression, $G_{3dB}$	18.8	18.5	18.2	dB

Notes:

1. Test conditions unless otherwise noted:  $T_A = 25\text{ °C}$ ,  $V_D = 65\text{ V}$ ,  $I_{DQ} = 750\text{ mA}$  (half device)
2. Pulsed, 100 us Pulse Width, 10% Duty Cycle.

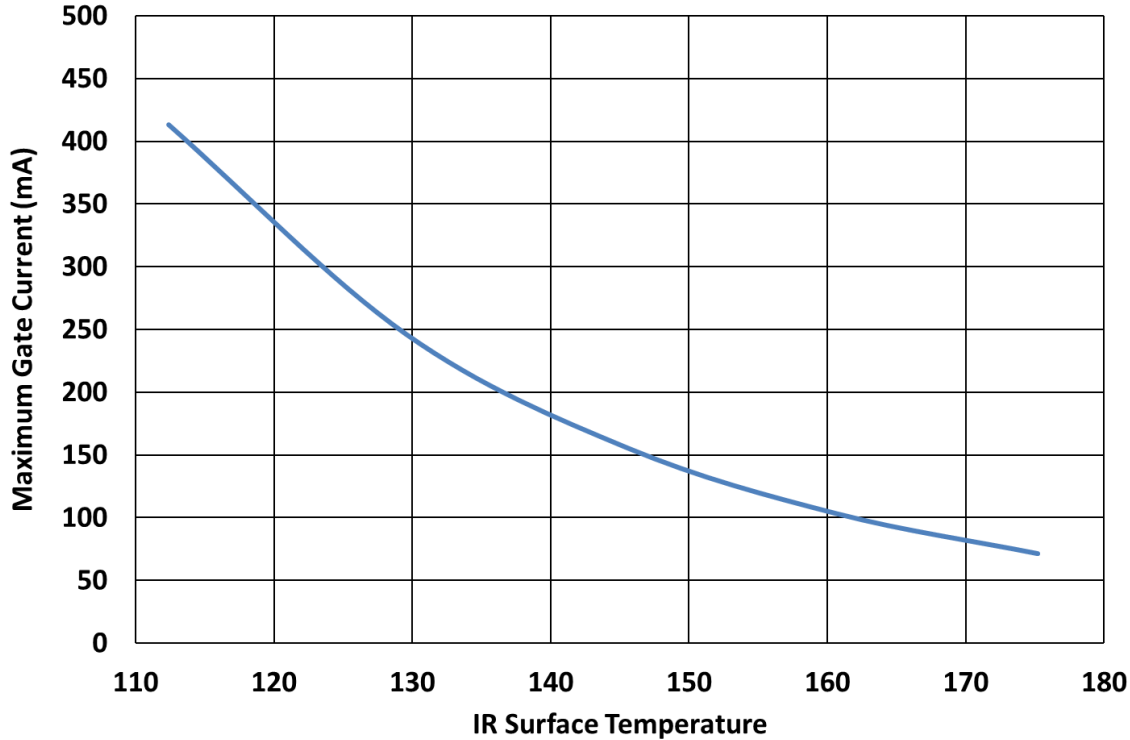
**Maximum Gate Current**
**Maximum Gate Current vs. IR Surface Temperature**

**RF Characterization – 1.2 – 1.4 GHz EVB4 Performance at 1.3 GHz <sup>1</sup>**

Parameter	Min	Typ	Max	Units
Linear Gain, $G_{LIN}$	–	19.8	–	dB
Output Power at 3dB compression point, P3dB	–	1350	–	W
Drain Efficiency at 3dB compression point, DEFF3dB	–	65	–	%
Gain at 3dB compression point, G3dB	–	16.5	–	dB
Gate Leakage $V_D = +10\text{ V}, V_G = -3.3\text{ V}$	- 40	–	–	mA

Notes:

- $V_D = 65\text{ V}, I_{DQ} = 1.5\text{ A}$  (combined), Temp = +25 °C, Pulse Width = 100 us, Duty Cycle = 10%

**RF Characterization – Mismatch Ruggedness at 1.2, 1.3, 1.4 GHz <sup>1, 2, 3</sup>**

Symbol	Parameter	dB Compression	Typical
VSWR	Impedance Mismatch Ruggedness	3	10:1

Notes:

- Test conditions unless otherwise noted:  $T_A = 25\text{ °C}, V_D = 65\text{ V}, I_{DQ} = 1.5\text{ A}$  (combined)
- Input drive power is determined at pulsed 3dB compression under matched condition at EVB output connector
- Pulse: 100us, 10% Duty cycle

**Peak IR Surface Temperature vs. Pulse Width**  
 Base temperature fixed at 85 °C, P<sub>diss</sub> Varies

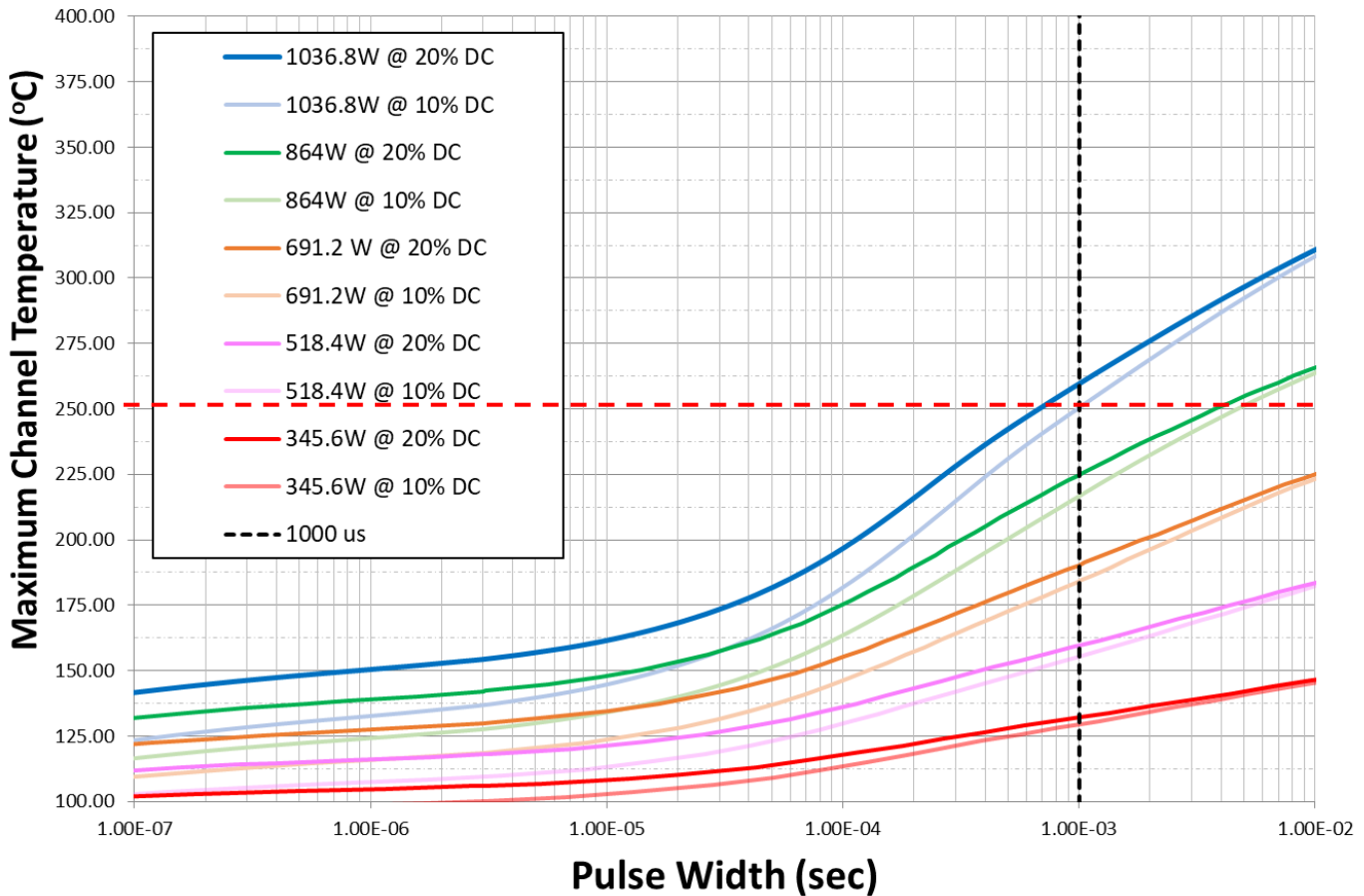

Parameter	Conditions	Values	Units
Thermal Resistance, IR <sup>1</sup> (θ <sub>JC</sub> )	85 °C Case backside Temperature	0.10	°C/W
Peak IR Surface Temperature <sup>1</sup> (T <sub>ch</sub> )	P <sub>diss</sub> = 518 W, Pulse: 300 us PW, 10% DC	139	°C

Notes:

1. Refer to the following document [GaN Device Channel Temperature, Thermal Resistance, and Reliability Estimates](#)

### Thermal and Reliability Information – Pulsed <sup>1</sup>

### Measured Load-Pull Smith Charts at 65V <sup>1, 2, 3</sup>

Notes:

1. Test Conditions:  $V_D = 65\text{ V}$ ,  $I_{DQ} = 750\text{ mA}$ , 100 us Pulse Width, 10% Duty Cycle, Temp = 25°C.
2. The performance shown below is for only half of the device out of the two independent amplification paths.
3. See "Pin Configuration and Description" for load pull reference planes where the performance was measured.

### 1.2GHz, Load-pull

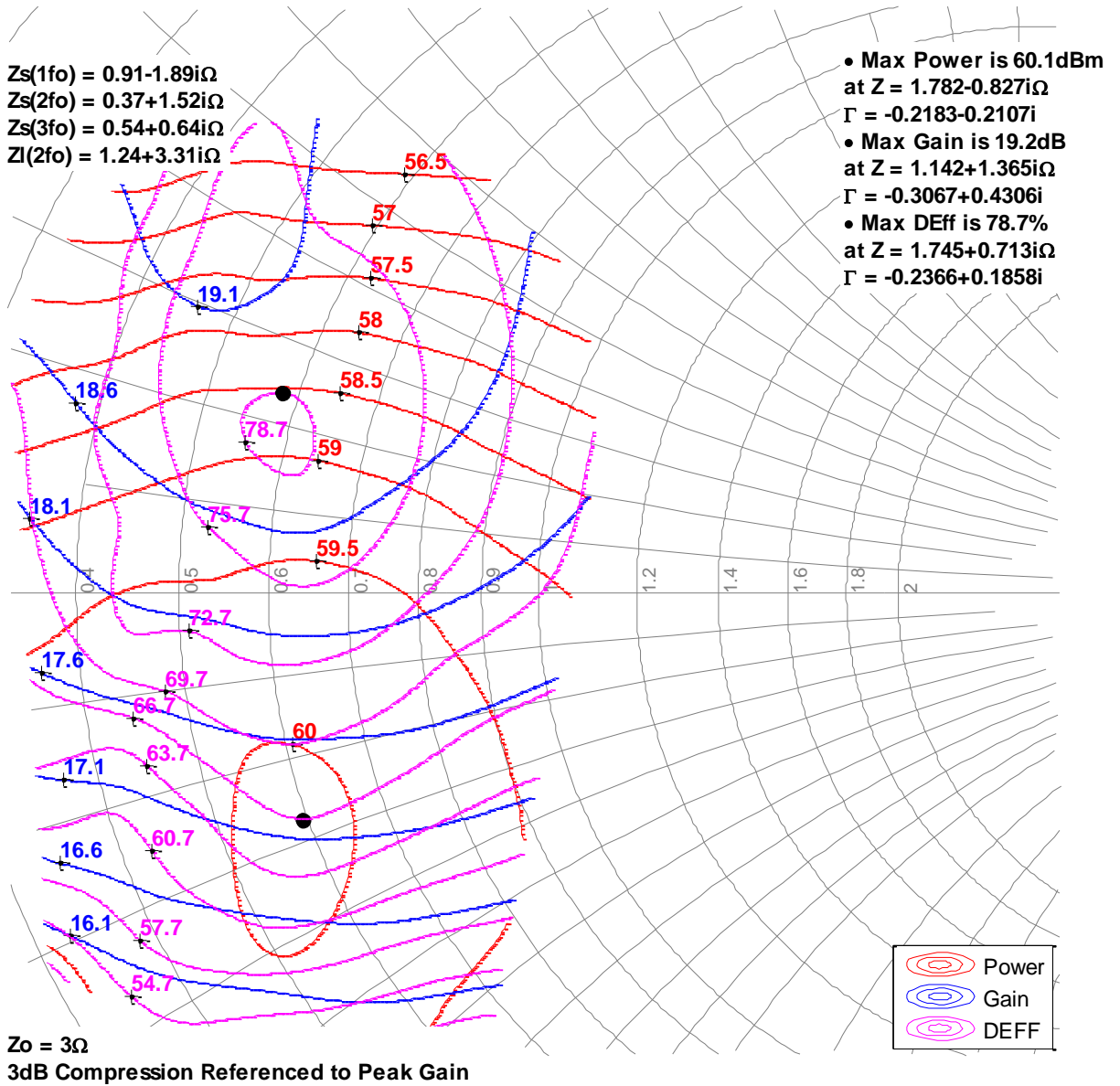

### Measured Load-Pull Smith Charts at 65V <sup>1, 2, 3</sup>

Notes:

1. Test Conditions:  $V_D = 65\text{ V}$ ,  $I_{DQ} = 750\text{ mA}$ , 100 us Pulse Width, 10% Duty Cycle, Temp = 25°C.
2. The performance shown below is for only half of the device out of the two independent amplification paths.
3. See "Pin Configuration and Description" for load pull reference planes where the performance was measured.

### 1.3GHz, Load-pull

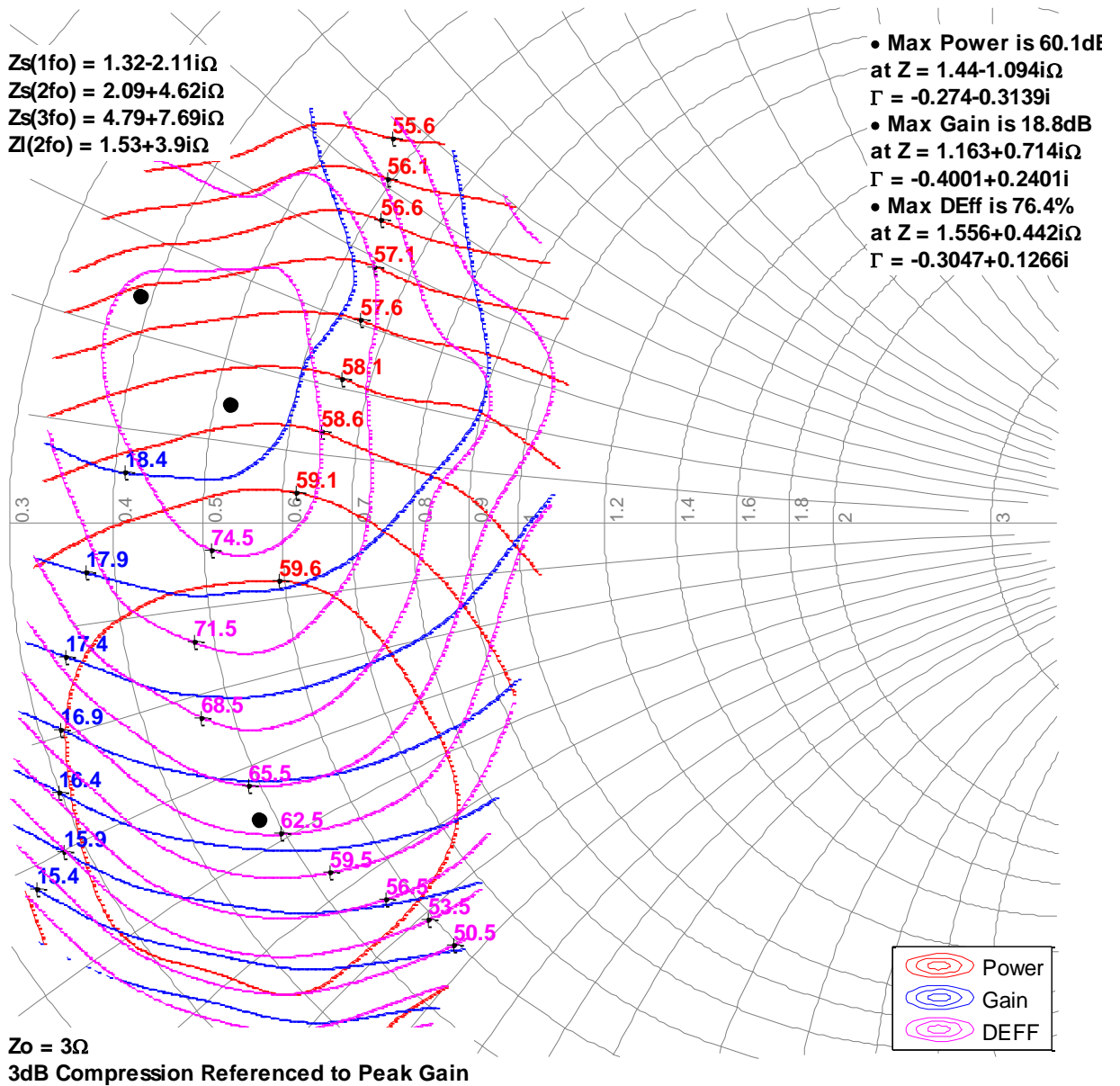

### Measured Load-Pull Smith Charts at 65V <sup>1, 2, 3</sup>

Notes:

1. Test Conditions:  $V_D = 65\text{ V}$ ,  $I_{DQ} = 750\text{ mA}$ , 100 us Pulse Width, 10% Duty Cycle, Temp = 25°C.
2. The performance shown below is for only half of the device out of the two independent amplification paths.
3. See "Pin Configuration and Description" for load pull reference planes where the performance was measured.

### 1.4GHz, Load-pull

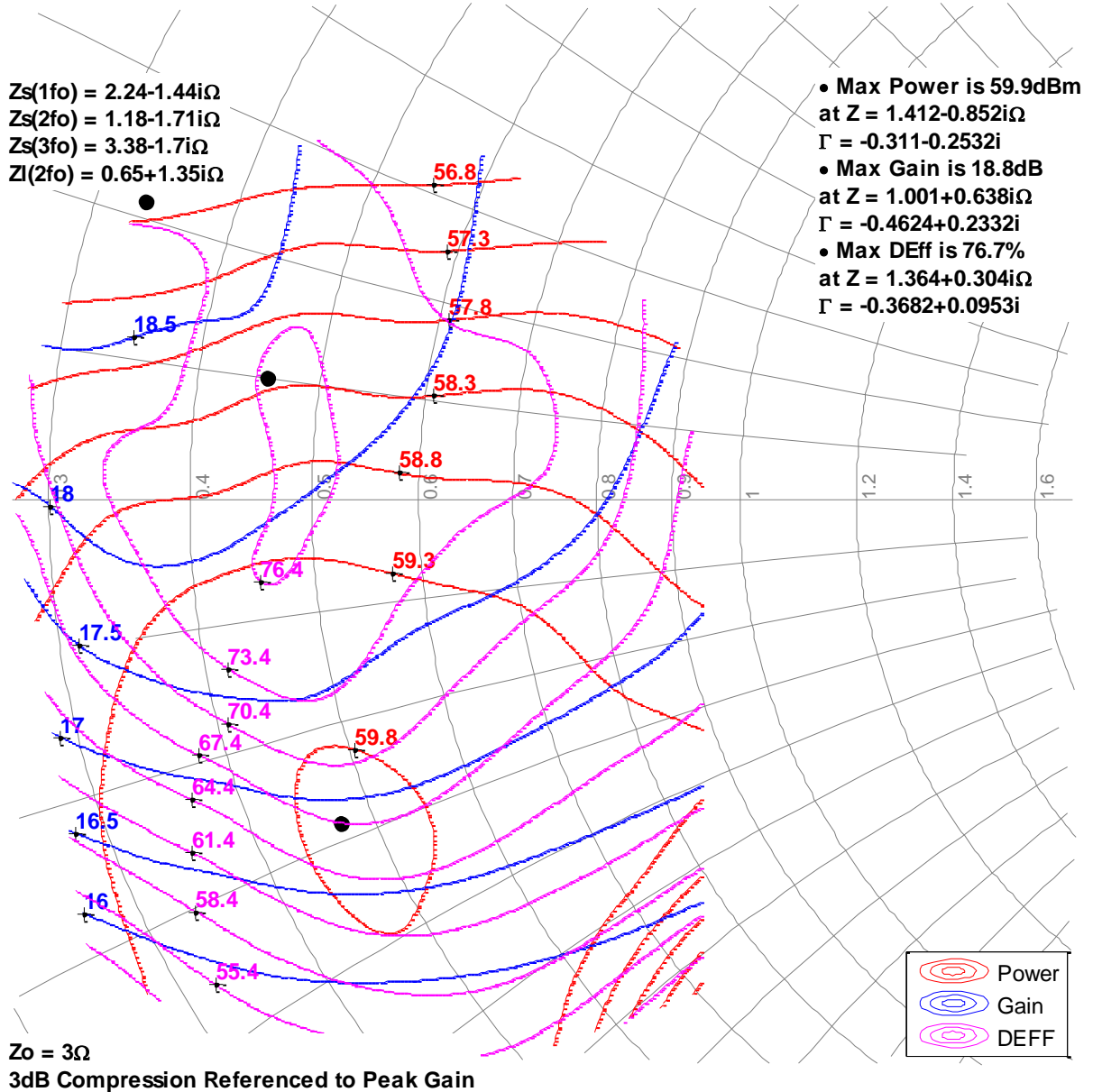

### Typical Measured Performance – Load-Pull Drive-up at 65V <sup>1, 2, 3</sup>

Notes:

1. Test Conditions:  $V_D = 65\text{ V}$ ,  $I_{DQ} = 750\text{ mA}$ , 100 us Pulse Width, 10% Duty Cycle, Temp = 25°C.
2. The performance shown below is for only half of the device out of the two independent amplification paths.
3. See "Pin Configuration and Description" for load pull reference planes where the performance was measured.

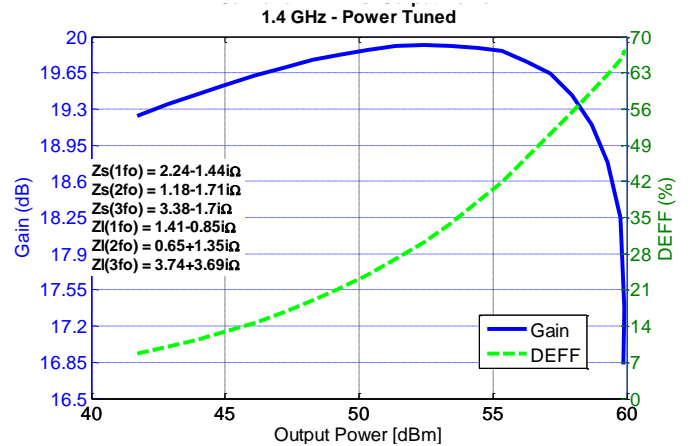
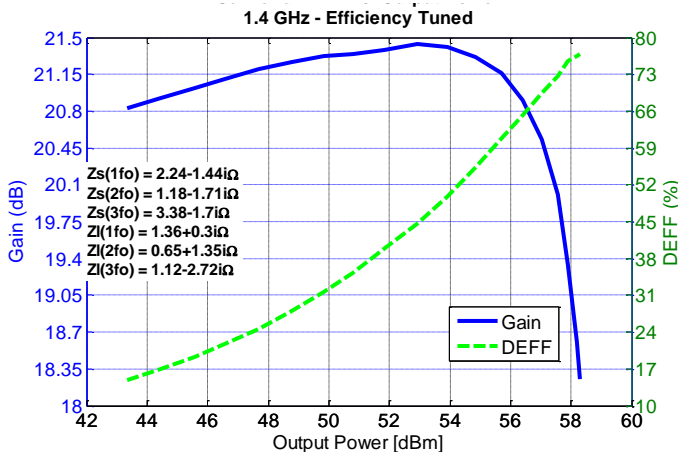
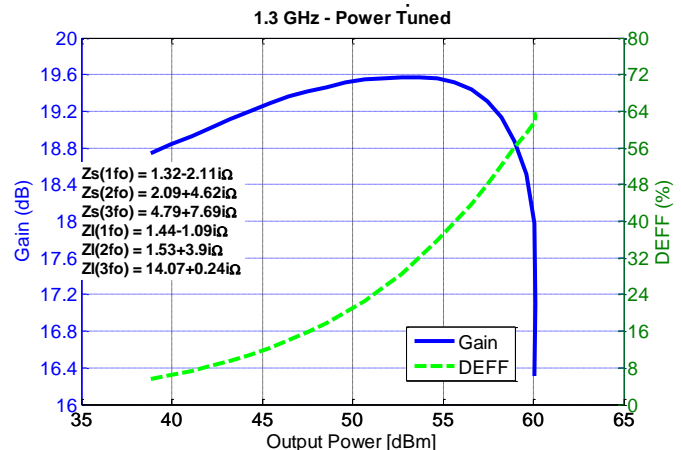
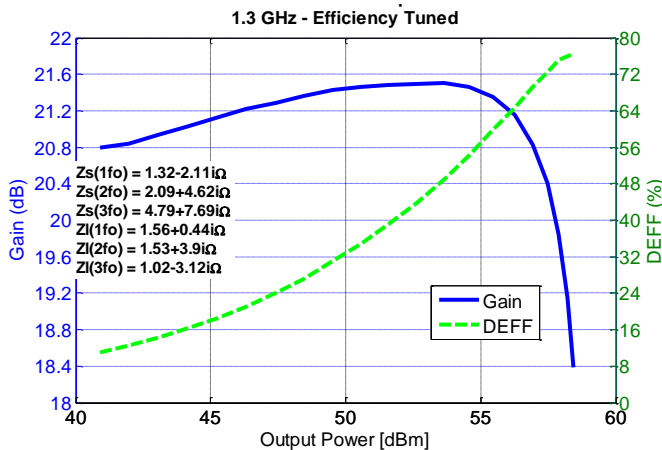
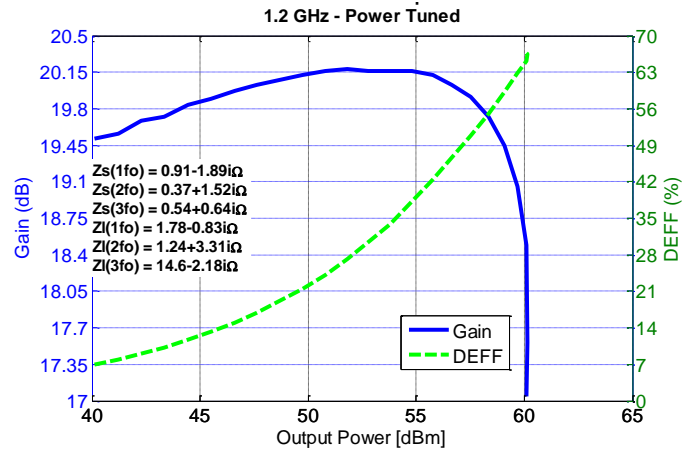
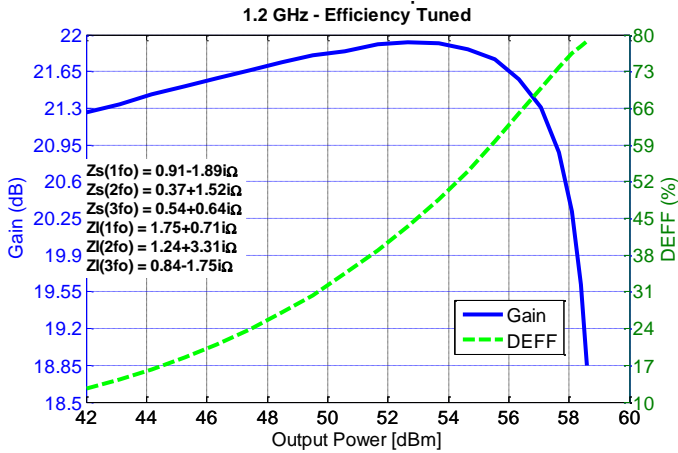



## Pin Configuration and Description <sup>1</sup>

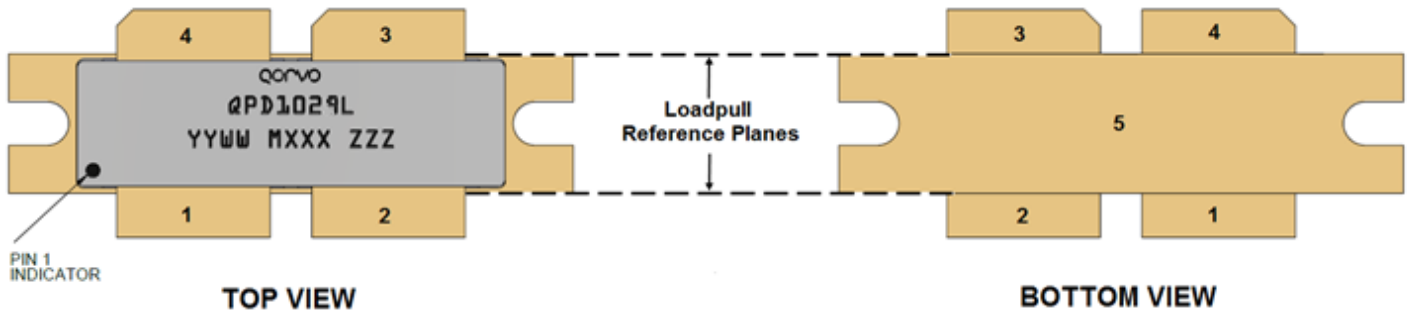

**Note:**

- The QPD1029L will be marked with the “QPD1029L” designator and a lot code marked below the part designator. The “YY” represents the last two digits of the calendar year the part was manufactured, the “WW” is the work week of the assembly lot start, the “MXXX” is the production lot number, and the “ZZZ” is an auto-generated serial number.

Pin	Symbol	Description
1, 2	RF IN / $V_G$	Gate
3, 4	RF OUT / $V_D$	Drain
5	Source	Source / Ground / Backside of part

## Mechanical Drawing (NI-1230)<sup>1-7</sup>

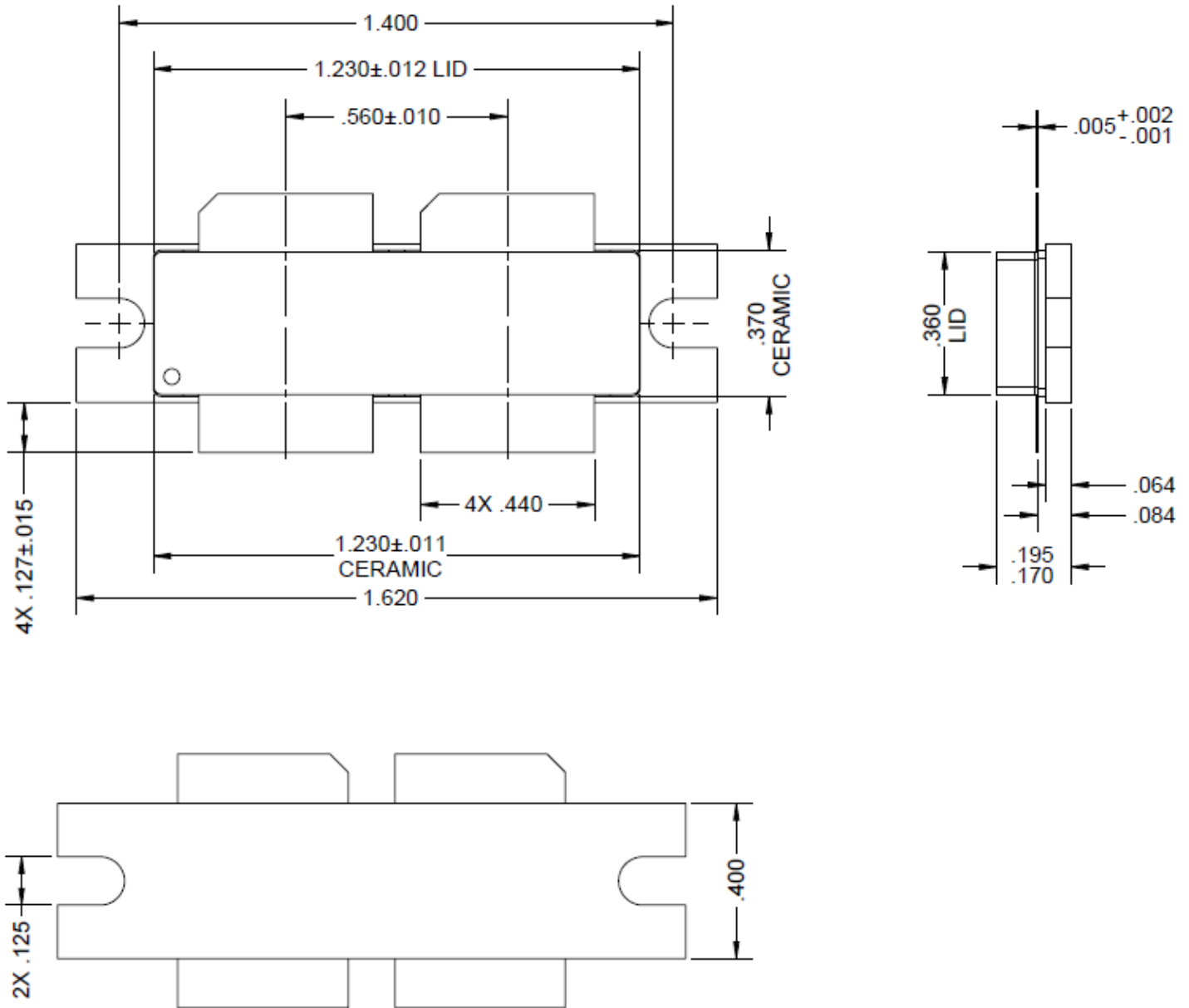

**Notes:**

1. All dimensions are in inches.
2. Dimension tolerance is ± 0.005 inches, unless noted otherwise.
3. Package base: Ceramic/Metal, Package lid: Ceramic
4. Package Metal base and leads are gold plated
5. Parts are epoxy sealed.
6. Parts meet industry NI1230 footprint
7. Body dimensions do not include runout which can be up to 0.020 inches per side.

## 1.2 – 1.4 GHz Application Circuit - Schematic

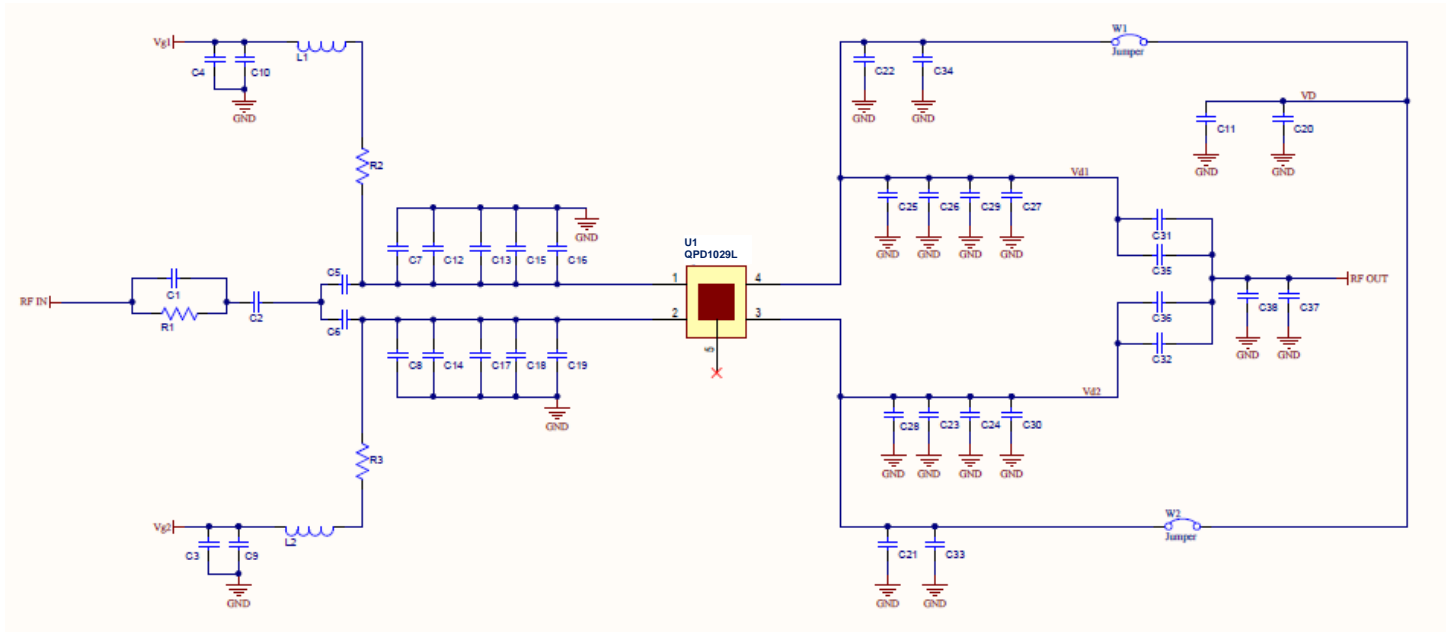

Bias-up Procedure	Bias-down Procedure
1. Set $V_G$ to -5 V.	1. Turn off RF signal.
2. Set $I_D$ current limit to 2 A.	2. Turn off $V_D$
3. Apply 65 V $V_D$ .	3. Wait 2 seconds to allow drain capacitor to discharge.
4. Slowly adjust $V_G$ until $I_D$ is set to 1.5 A.	4. Turn off $V_G$
5. Apply RF.	

### 1.2 – 1.4 GHz Application Circuit EVB4 – Layout <sup>1, 2, 3</sup>

Notes:

1. PCB material is RO4350B 0.020" thick, 2 oz. copper each side.
2. The two gates could be tied together or (optionally) adjusted independently.
3. EVB is rated for pulsed operation only

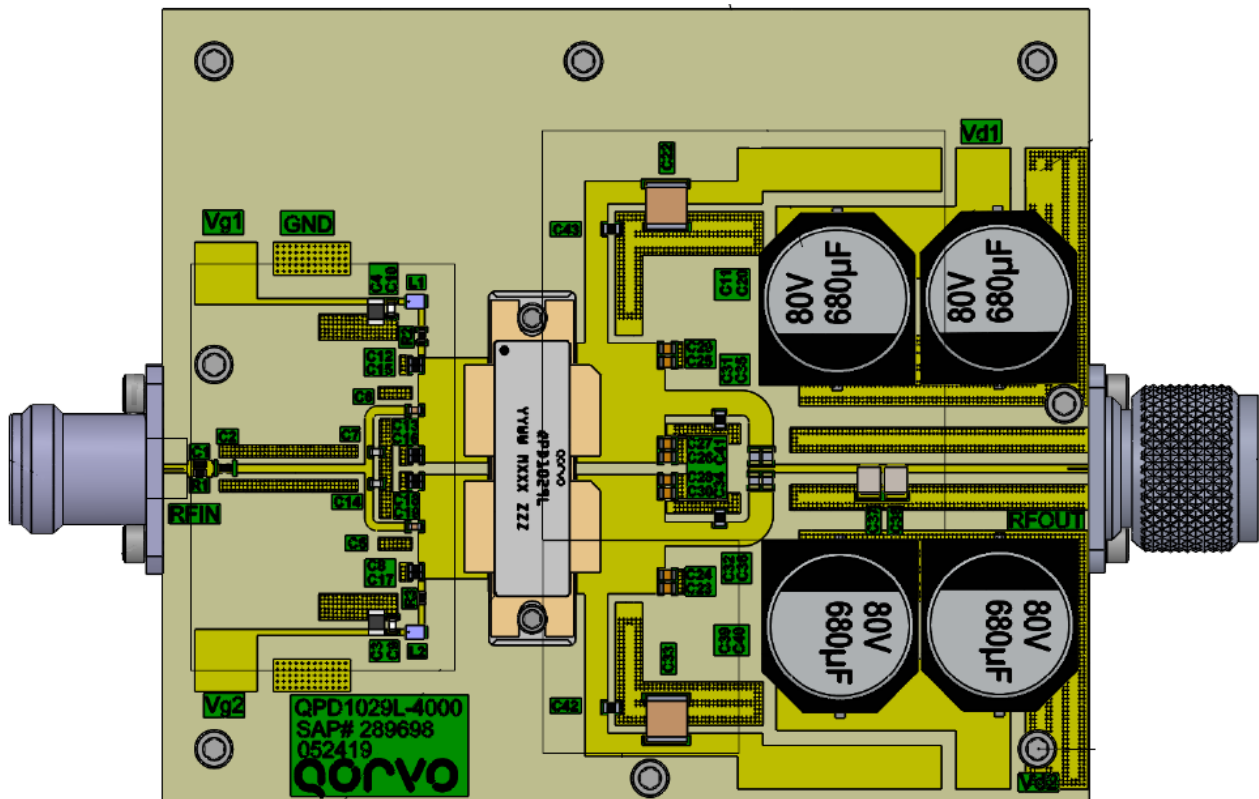

## 1.2 – 1.4 GHz Application Circuit – Bill of Material EVB4

Ref Des	Qty	Description	Mfg Name	Mfg Part #
U1	1	1500W, 65V, Pre-matched, 1.2-1.4GHz, Fla	Qorvo	QPD1029L
C7,C14	2	CAP, 3.0PF, +/-0.1pF, 250V, HI-Q, 0603	American Technical Ceramics	600S3R0BW250XT
C1,C2	2	CAP, 24pF, 1%, 250V, COG, 0603	American Technical Ceramics	600S240FT250XT
C31,C32,C35,C36	4	CAP, 2.2pF, 0.1pF, 250V, COG, 0805	American Technical Ceramics	600F2R2BT250XT
C23,C25,C26,C30	4	CAP, 3.3pF, 0.1pF, 250V, COG, 0805	American Technical Ceramics	600F3R3BT250XT
C24,C27,C28,C29,C34,C41	6	CAP, 3.9pF, 0.1pF, 250V, COG, 0805	American Technical Ceramics	600F3R9BT250XT
C9,C10	2	CAP, 27pF, 5%, 250V, NPO, 0603	American Technical Ceramics	600S270JT250XT
C5,C6	2	CAP, 82pF, 5%, 250V, HI-Q, COG, 0603	American Technical Ceramics	600S820JT250XT
C8,C12,C13,C15,C16,C17,C18,C19	8	CAP, 2.7pF, 0.1pF, 250V, 0603	American Technical Ceramics	600S2R7BT250XT
C3,C4	2	CAP, 4.7uF, 10%, 50V, X7R, 1206	MURATA ELECTRONICS SINGAPORE PTE LT	GRM31CR71H475KA12L
C22,C33	2	CAP, 10uF, 20%, 100V, X7S, 2220	TDK SINGAPORE (PTE) LTD	C5750X7S2A106M230KB
C42,C43	2	CAP, 47pF, 5%, 250V, HI-Q, 0805	American Technical Ceramics	600F470JT250XT
C11,C20,C39,C40	2	CAP, 680uF, ±20%, 80V, Alum Cap, SMD	VISHAY AMERCIAS INC	MAL215099708E3
C37,C38	2	CAP, 1.8pF, 0.1 pF, 500V, COG, 1111, SMD	American Technical Ceramics	800B1R8BT500XT
R2,R3	2	RES, 10 OHM, 1%, 0.1W, 0603	KOA Speer Electronics, Inc.	RK73H1JTTD10R0F
R1	1	RES, 100 OHM, 1%, 0.1W, 0603	Kamaya, Inc	RMC1/16K1000FTP
R1	1	RES, 100 OHM, ±5%, 1/10W, 0603	VISHAY AMERCIAS INC	CRCW0603100RJNTA
R1	1	RES, 100 OHM, 1%, 1/10W, 0603	Panasonic Industrial Devices Sales	ERJ-3EKF1000V
L1,L2	2	Ind0805 WW 110nH ROHS	Coilcraft, Inc.	0805CS-111XGRC
L1,L2	2	IND, 110nH, 5%, W/W, 0805	Coilcraft, Inc.	0805CS-111XJBC
RFOUT	1	CONN, SERIES N, STRIPLINE LAUNCHER, MALE	HUBER+SUHNER, Inc.	22642834
RFIN	1	CONN, COAXIAL, 11 GHz, N-FLANGE, FEMALE	HUBER+SUHNER, Inc.	23_N-50-0-33/133_NE

### Power Driveup Performance over Temperatures of 1.2 – 1.4 GHz EVB1 <sup>1</sup>

Notes:

1. Test Conditions:  $V_D = 65\text{ V}$ ,  $I_{DQ} = 1.5\text{ A}$ , 100 us Pulse Width, 10% Duty Cycle.

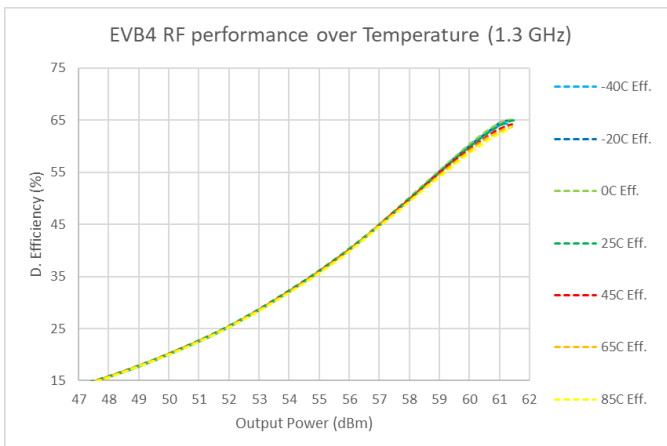
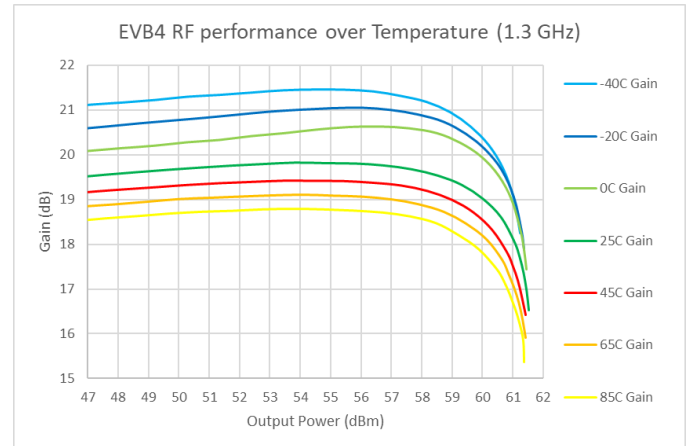
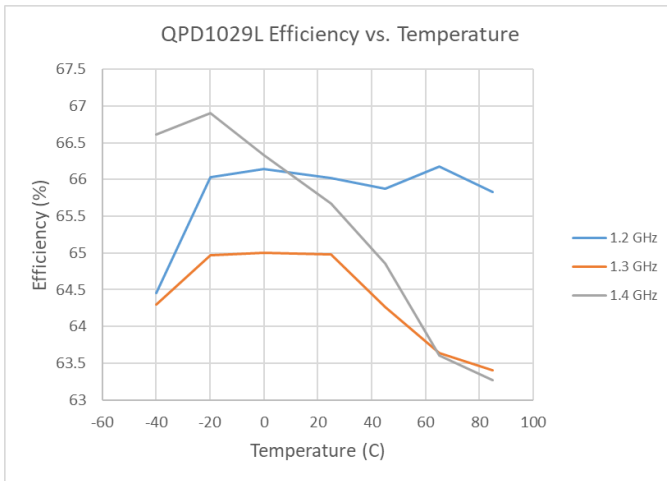
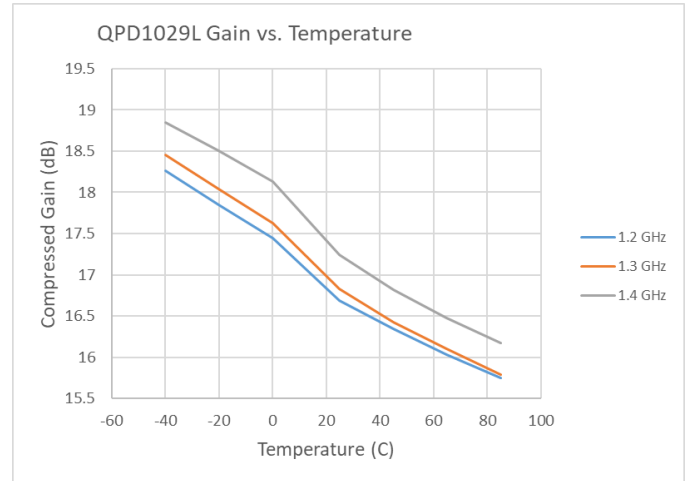
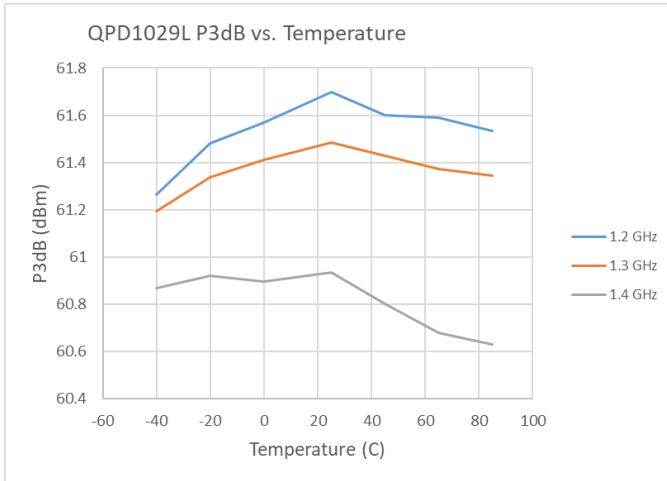

Recommended Solder Temperature Profile

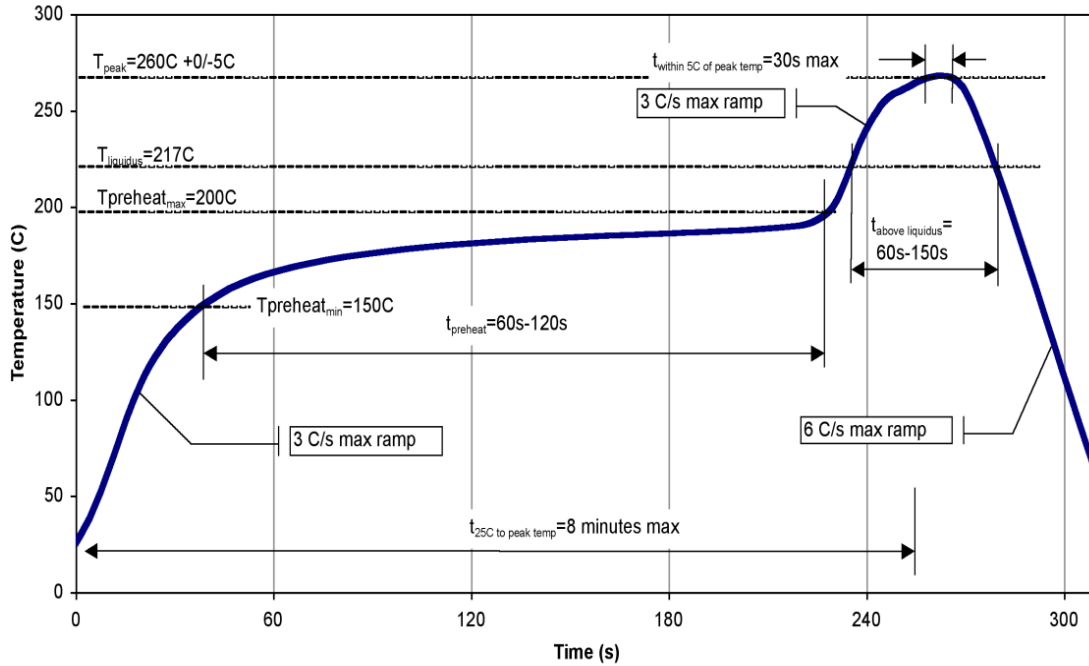

### Handling Precautions

Parameter	Rating	Standard
ESD – Human Body Model (HBM)	Class 1B	JEDEC JS-001
ESD – Charged Device Model (CDM)	Class C3	JEDEC JS-002
MSL – Moisture Sensitivity Level	MSL3	JESD J-STD-020 (260°C Convection reflow)



Caution!  
ESD-Sensitive Device

### Solderability

Compatible with both lead-free (260°C max. reflow temp.) and tin/lead (245°C max. reflow temp.) soldering processes.

Solder profiles available upon request.

The use of no-clean solder to avoid washing after soldering is recommended.

Contact plating: NiAu. Minimum Au thickness is 100micro-inches

### RoHS Compliance

This part is compliant with 2011/65/EU RoHS directive (Restrictions on the Use of Certain Hazardous Substances in Electrical and Electronic Equipment) as amended by Directive 2015/863/EU.

This product also has the following attributes:

- Halogen Free (Chlorine, Bromine)
- Antimony Free
- TBBP-A (C<sub>15</sub>H<sub>12</sub>Br<sub>4</sub>O<sub>2</sub>) Free
- PFOS Free
- SVHC Free

### Contact Information

For the latest specifications, additional product information, worldwide sales and distribution locations, and information about Qorvo:

Web: [www.qorvo.com](http://www.qorvo.com)

Tel: +1.844.890.8163

Email: [info-sales@qorvo.com](mailto:info-sales@qorvo.com)

For technical questions and application information:

Email: [info-products@qorvo.com](mailto:info-products@qorvo.com)

### Important Notice

The information contained herein is believed to be reliable; however, Qorvo makes no warranties regarding the information contained herein and assumes no responsibility or liability whatsoever for the use of the information contained herein. All information contained herein is subject to change without notice. Customers should obtain and verify the latest relevant information before placing orders for Qorvo products. The information contained herein or any use of such information does not grant, explicitly or implicitly, to any party any patent rights, licenses, or any other intellectual property rights, whether with regard to such information itself or anything described by such information. **THIS INFORMATION DOES NOT CONSTITUTE A WARRANTY WITH RESPECT TO THE PRODUCTS DESCRIBED HEREIN, AND QORVO HEREBY DISCLAIMS ANY AND ALL WARRANTIES WITH RESPECT TO SUCH PRODUCTS WHETHER EXPRESS OR IMPLIED BY LAW, COURSE OF DEALING, COURSE OF PERFORMANCE, USAGE OF TRADE OR OTHERWISE, INCLUDING THE IMPLIED WARRANTIES OF MERCHANTABILITY AND FITNESS FOR A PARTICULAR PURPOSE.**

Without limiting the generality of the foregoing, Qorvo products are not warranted or authorized for use as critical components in medical, life-saving, or life-sustaining applications, or other applications where a failure would reasonably be expected to cause severe personal injury or death.

Copyright 2018 © Qorvo, Inc. | Qorvo is a registered trademark of Qorvo, Inc.



# Mouser Electronics

Authorized Distributor

Click to View Pricing, Inventory, Delivery & Lifecycle Information:

[Qorvo:](#)

[QPD1029L](#) [QPD1029LEVB4](#) [QPD1029LEVB5](#)