

Product Description

Qorvo’s QPA1010 is a X-band high power MMIC amplifier fabricated on Qorvo’s production 0.15um GaN on SiC process (QGaN15). The QPA1010 operates from 7.9 – 11 GHz and typically provides 15 W saturated output power with power-added efficiency of 38% and large-signal gain of 18 dB. This combination of wideband performance provides the flexibility designers are looking for to improve system performance while reducing size and cost.

QPA1010 can also support a variety of operating conditions to best support system requirements. With good thermal properties, it can support a range of bias voltages and will perform well under both CW and pulse operations.

The QPA1010 is matched to 50Ω with integrated DC blocking capacitors on both RF I/O ports simplifying system integration. The wideband performance and operational flexibility allow it support satellite communication and data links, as well as, military and commercial radar systems.

Lead-free and RoHS compliant.

Functional Block Diagram

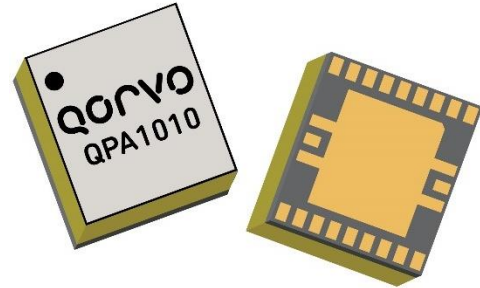
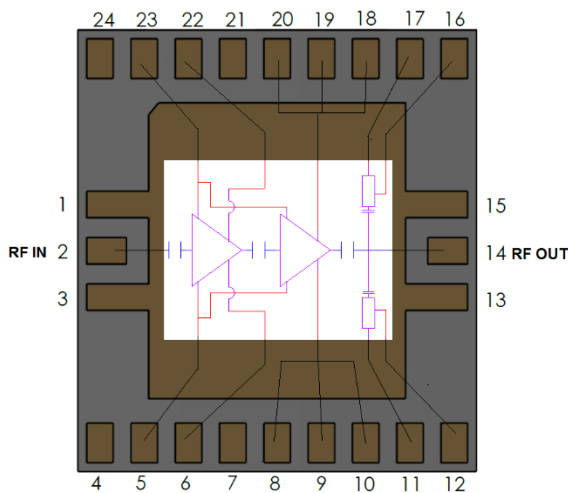

24-Lead 4.5 x 5.0 x 1.72 mm Air Cavity Laminate Package

Product Features

- Frequency Range: 7.9–11 GHz
- P_{OUT}: 42 dBm at P_{IN} = 24 dBm
- PAE: 38 % at P_{IN} = 24 dBm
- Large Signal Gain: 18 dB at P_{IN} = 24 dBm
- Small Signal Gain: 25 dB
- Integrated Power Detector
- Bias: V_D = 24 V, I_{DQ} = 600 mA
- Pulsed V_D: PW =100 μS, DC = 10%
- Package Dimensions: 4.5 x 5.0 x 1.72 mm

Performance is typical across frequency. Please reference electrical specification table and data plots for more details.

Applications

- Satellite Communications
- Data Links
- Military and Commercial Radar

Ordering Information

Part No.	Description
QPA1010	7.9 – 11 GHz 15W GaN Power Amplifier
QPA1010S2	Samples (2 pcs. pack)
QPA1010PCB4B01	Evaluation Board



Absolute Maximum Ratings

Parameter	Value / Range
Drain Voltage (V_D)	29.5 V
Gate Voltage Range (V_G)	-8 to 0V
Drain Current (I_{D1}/I_{D2})	672 mA / 1440 mA
Gate Current (I_G)	See chart, pg. 21
Power Dissipation (P_{DISS}), 85°C, CW	38 W
Input Power (P_{IN}), CW, 50Ω, $V_D=28$ V, $I_{DQ}=600$ mA, 85 °C	30 dBm
Input Power (P_{IN}), CW, VSWR 3:1, $V_D=28$ V, $I_{DQ}=600$ mA 85 °C	30 dBm
Mounting Temperature (30 seconds)	260 °C
Storage Temperature	-55 to 150 °C

Operation of this device outside the parameter ranges given above may cause permanent damage. These are stress ratings only, and functional operation of the device at these conditions is not implied.

Recommended Operating Conditions

Parameter	Value / Range
Drain Voltage (V_D)	24 V
Drain Current (I_{DQ})	600 mA
Gate Voltage Range (V_G)	-2.9 to -1.5 V
Temperature (T_{BASE})	-40 to +85 °C

Electrical specifications are measured at specified test conditions. Specifications are not guaranteed over all recommended operating conditions.

Electrical Specifications

Parameter		Min	Typ	Max	Units
Operational Frequency Range		7.9		11	GHz
Output Power ($P_{IN} = 24$ dBm)	7.9 GHz		41.7		dBm
	9.0 GHz		42.3		dBm
	11.0 GHz		41.8		dBm
	12.0 GHz		41.0		dBm
Power Added Efficiency ($P_{IN} = 24$ dBm)	7.9 GHz		37.7		%
	9.0 GHz		38.6		%
	11.0 GHz		37.3		%
	12.0 GHz		40.1		%
3 rd Order Intermodulation Level ($P_{OUT}/Tone = 35$ dBm)	7.9 GHz		-21		dBc
	10.0 GHz		-21		dBc
	11.0 GHz		-22		dBc
	12.0 GHz		-21		dBc
Small Signal Gain	7.9 GHz		27.9		dB
	9.0 GHz		27.8		dB
	11.0 GHz		26.0		dB
	12.0 GHz		21.1		dB
Input Return Loss	7.9 GHz		17		dB
	9.0 GHz		22		dB
	11.0 GHz		21		dB
	12.0 GHz		10		dB
Output Return Loss	7.9 GHz		11		dB
	9.0 GHz		11		dB
	11.0 GHz		18		dB
	12.0 GHz		7		dB
Output Power Temperature Coefficient (25 – 85 °C) ($P_{IN} = 24$ dBm)			-0.003		dB/°C
Small Signal Gain Temperature Coefficient (25 – 85 °C)			-0.044		dB/°C
Gate Leakage ($V_d=10V, V_g=-4.0V$, all gates together)		-6.6	-3.0	-0.0001	mA
Recommended Voltage Operations			24	28	V

Test conditions, unless otherwise noted: 25 °C, Pulsed V_D : PW = 100 μ S, DC = 10%, $V_D = 24$ V, $I_{DQ} = 600$ mA, $V_G = -1.8$ V Typical

Performance Plots – Large Signal (Pulsed)

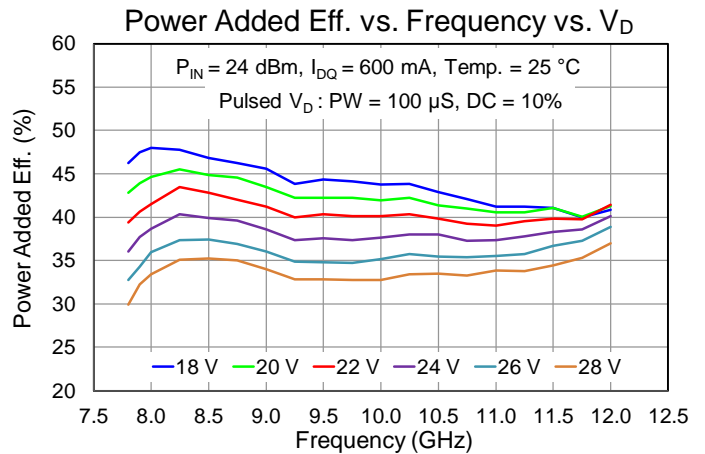
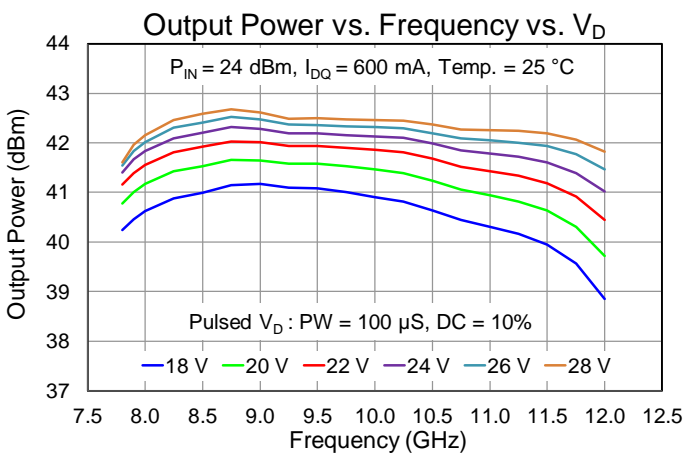
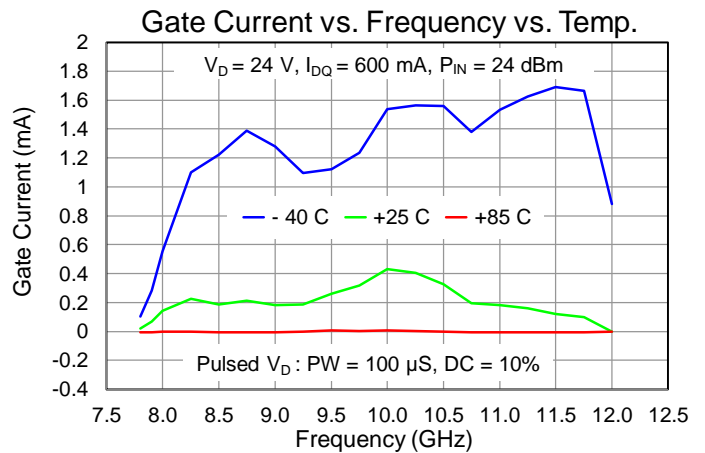
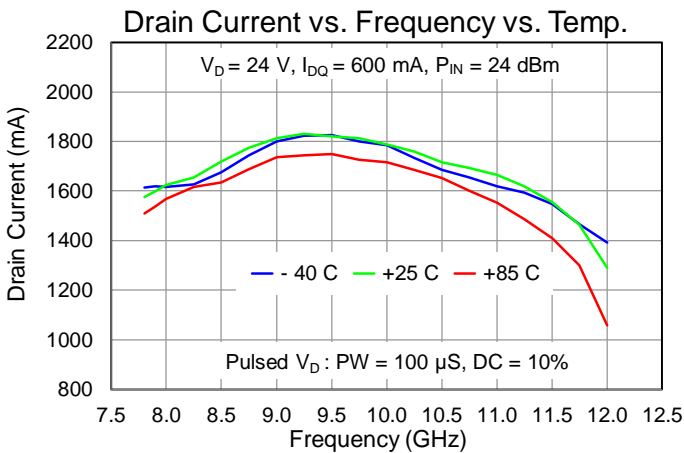
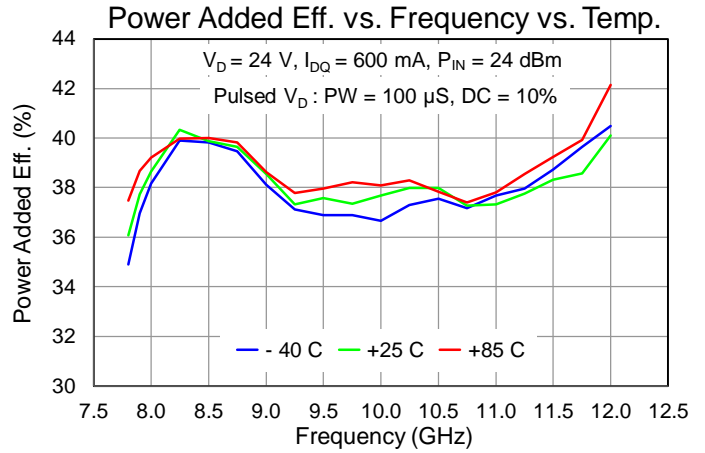
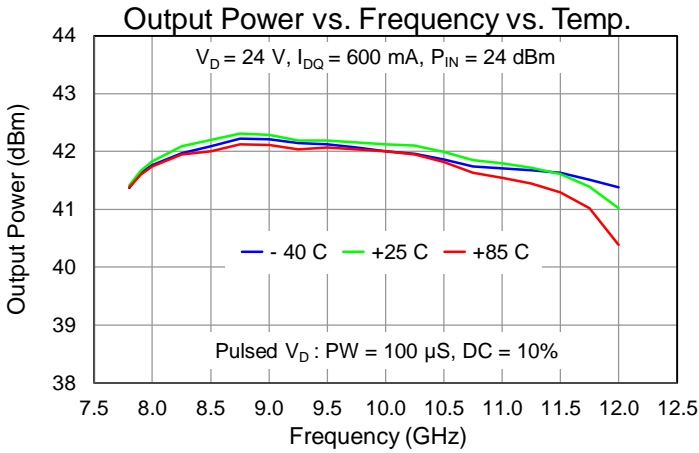

Performance Plots – Large Signal (Pulsed)

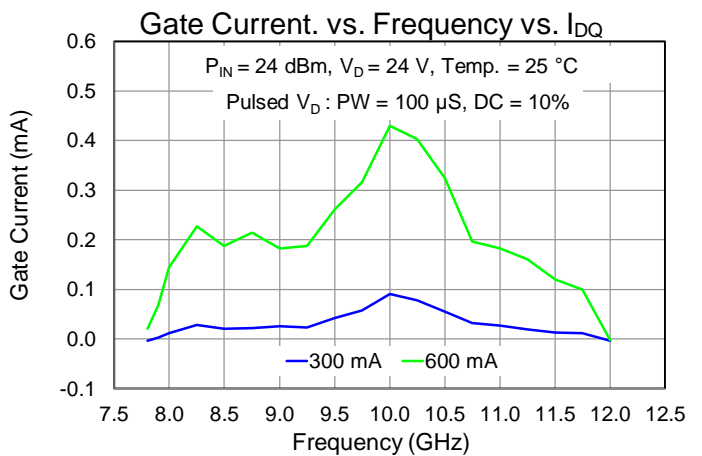
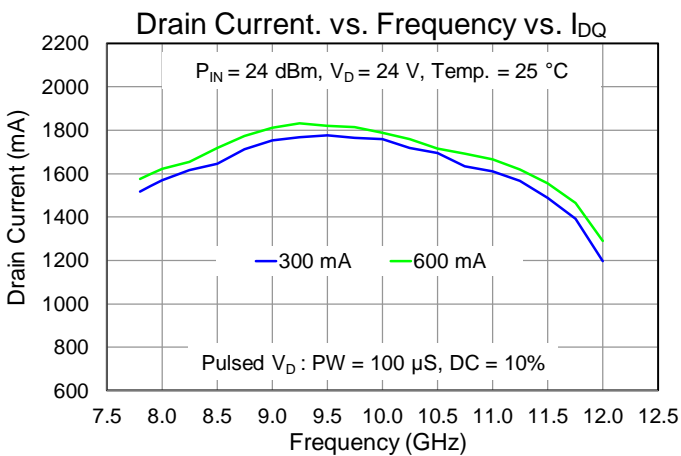
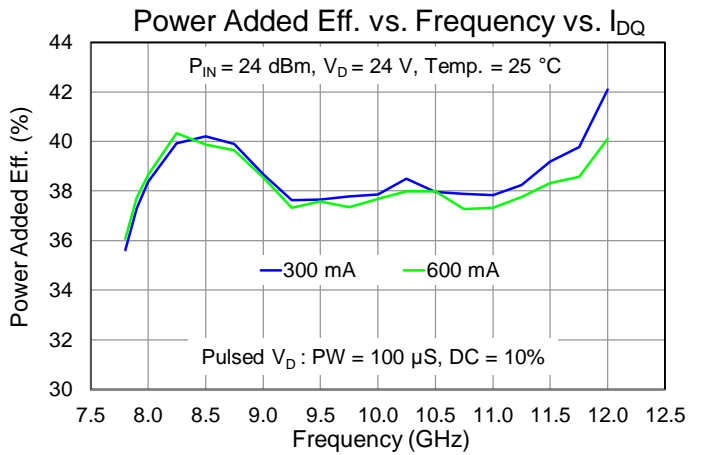
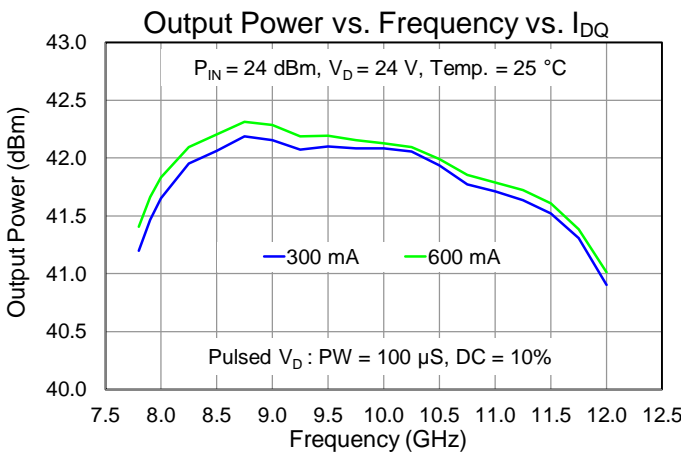
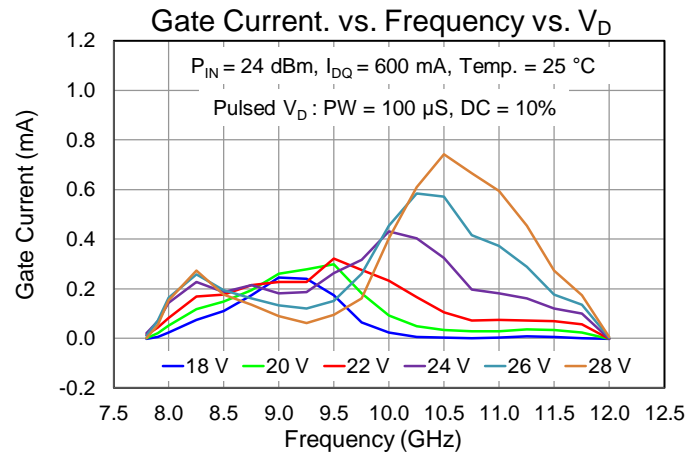
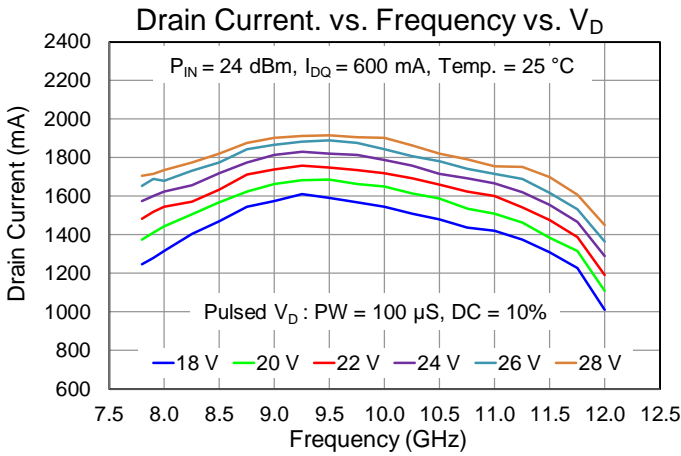

Performance Plots – Large Signal (Pulsed)

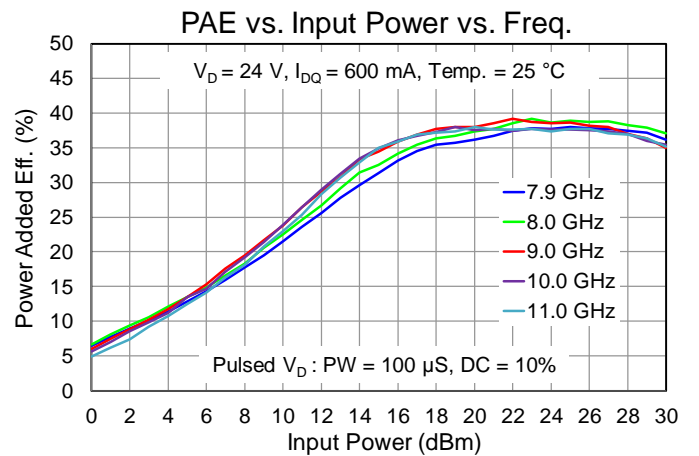
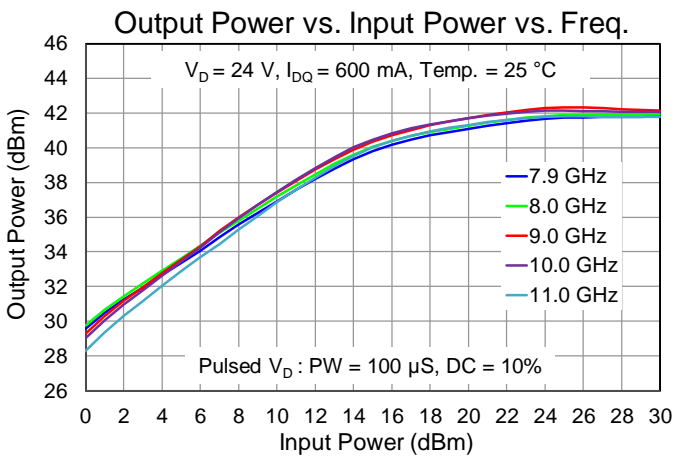
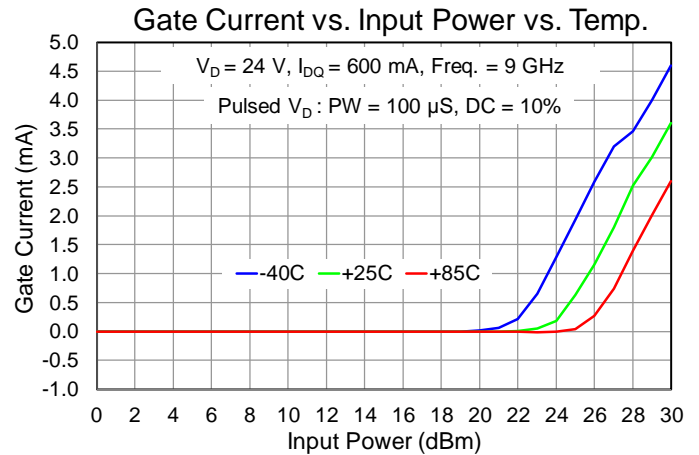
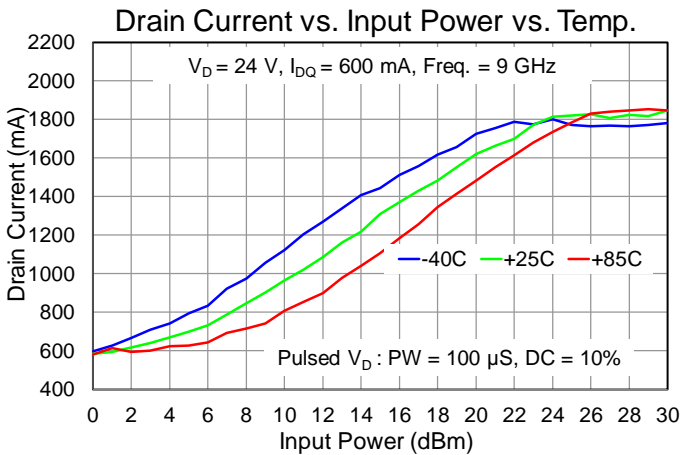
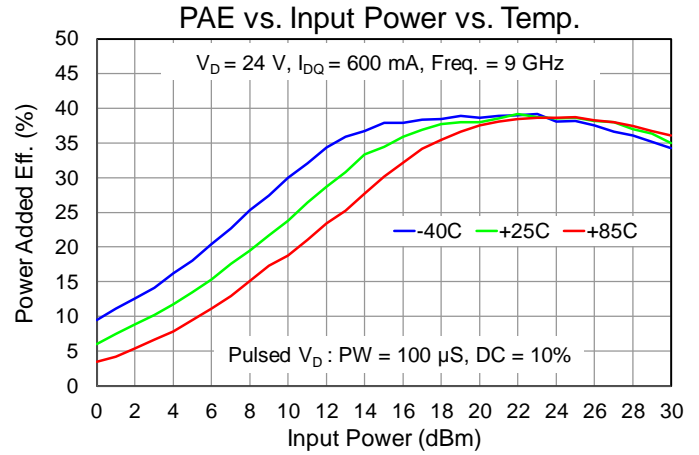
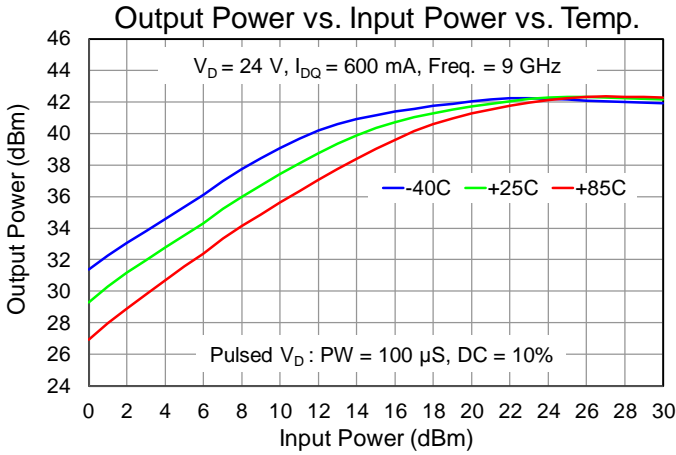

Performance Plots – Large Signal (Pulsed)

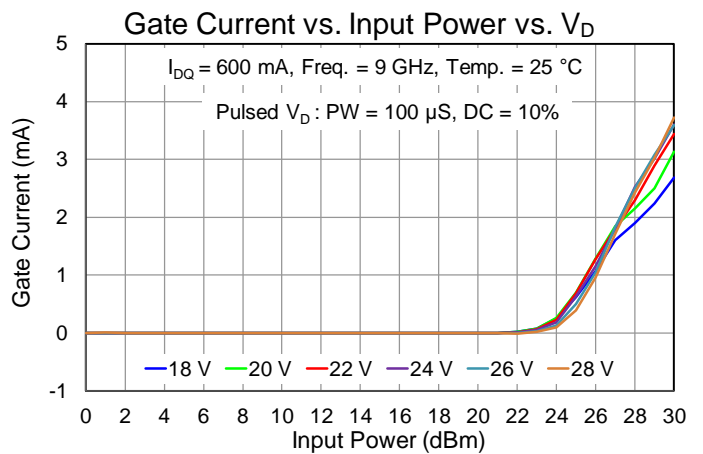
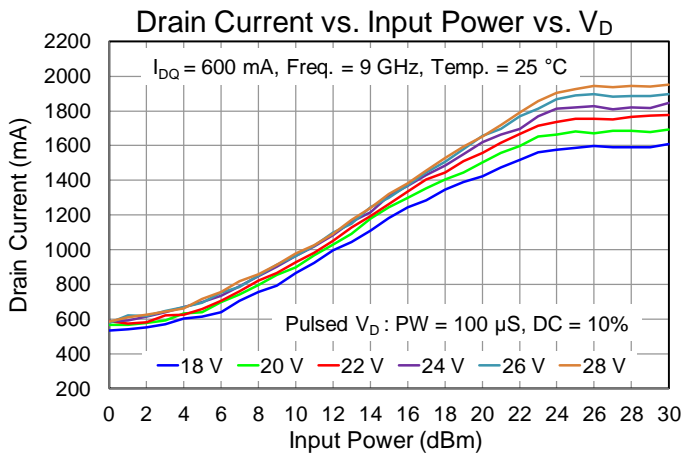
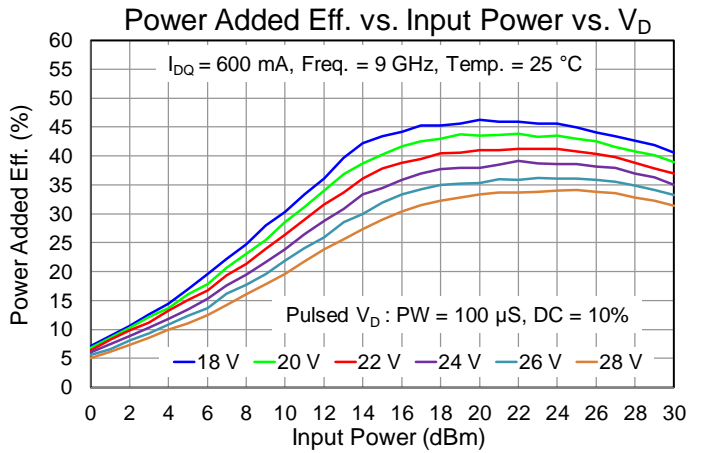
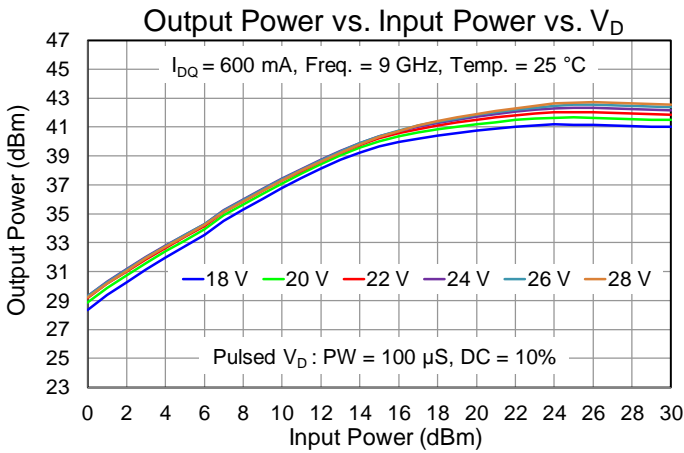
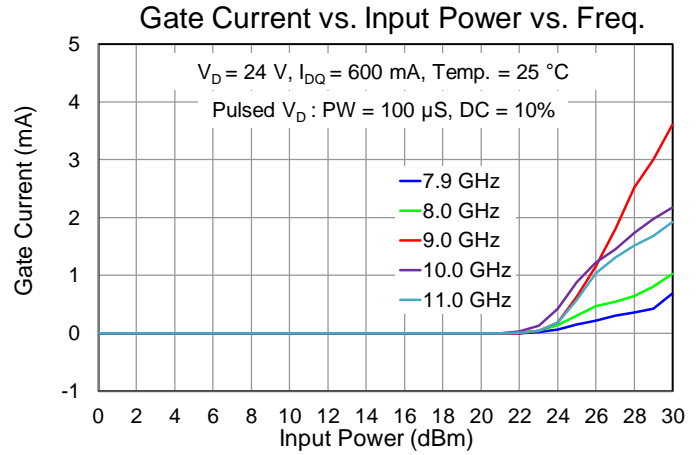
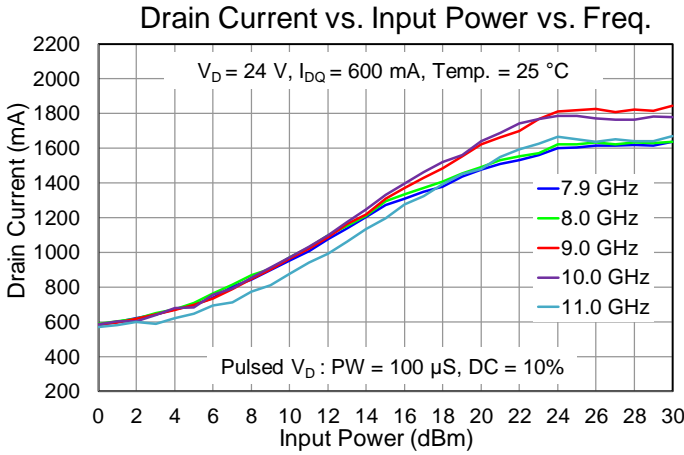

Performance Plots – Large Signal (CW)

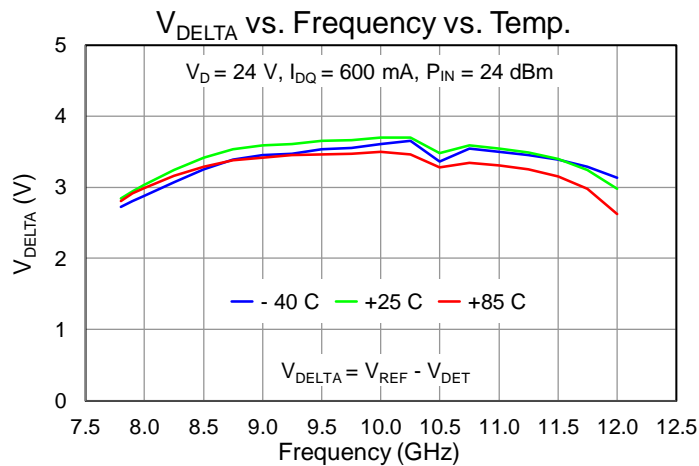
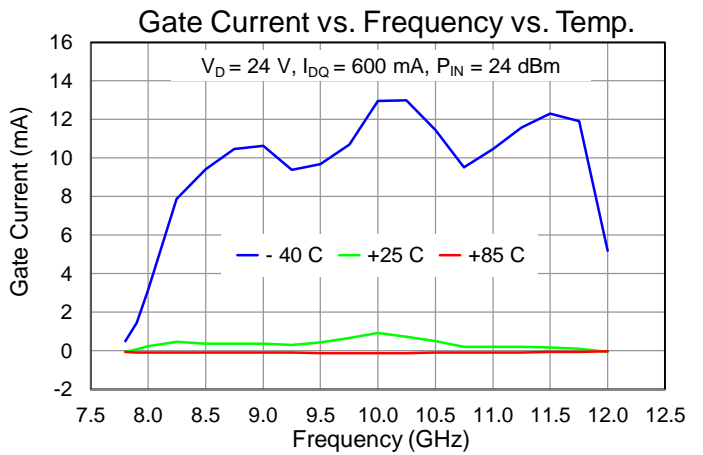
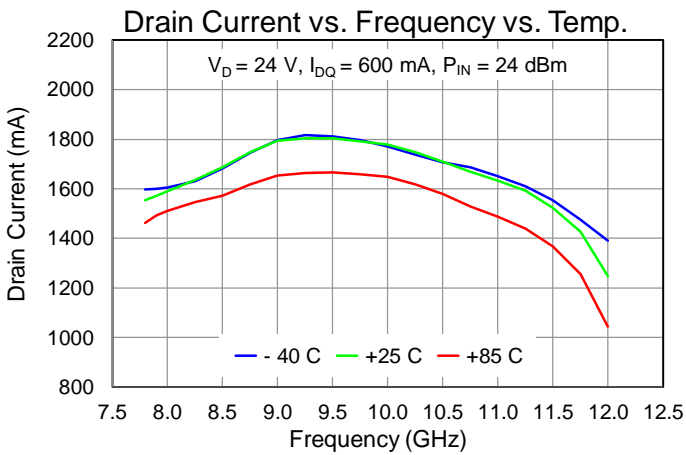
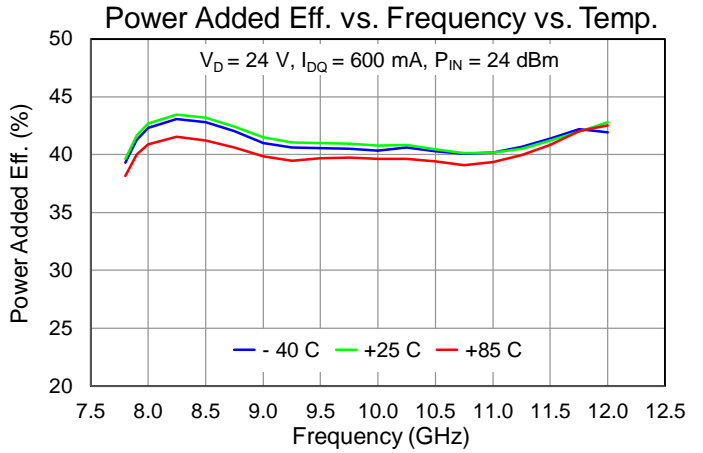
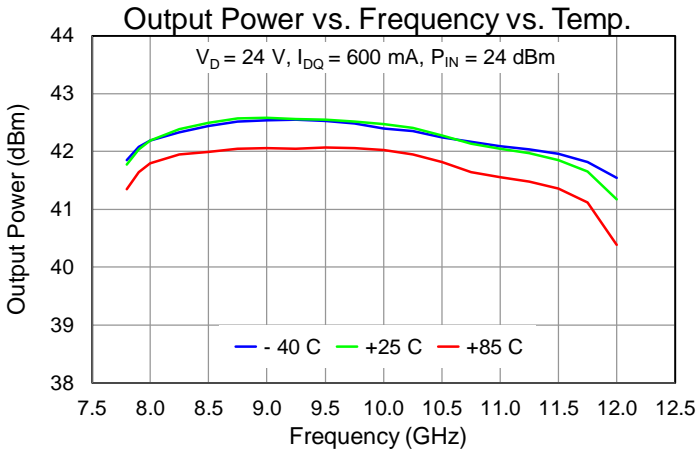

Performance Plots – Large Signal (CW)

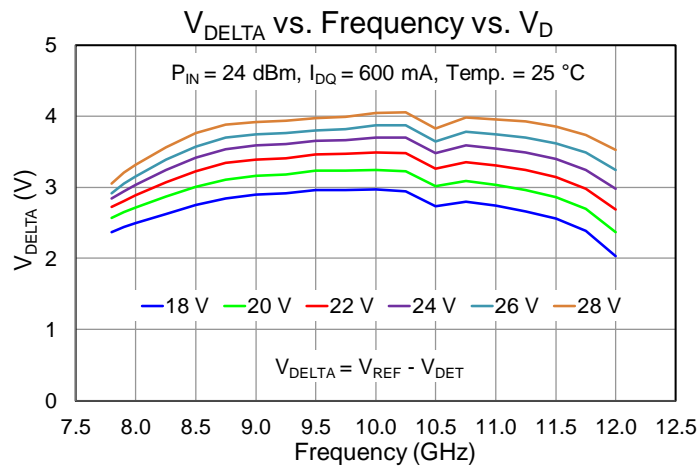
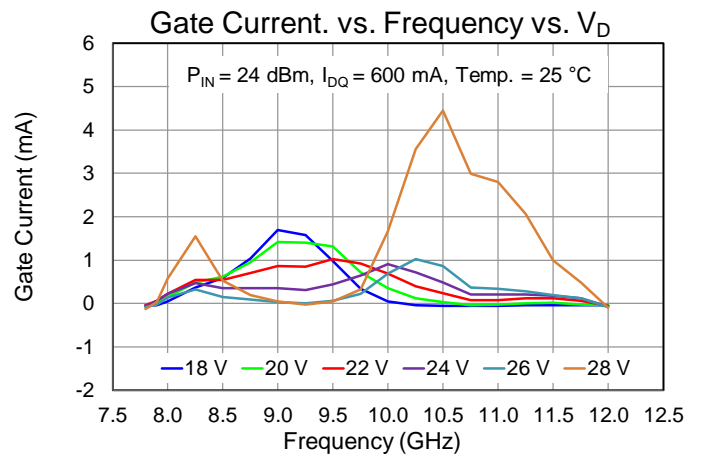
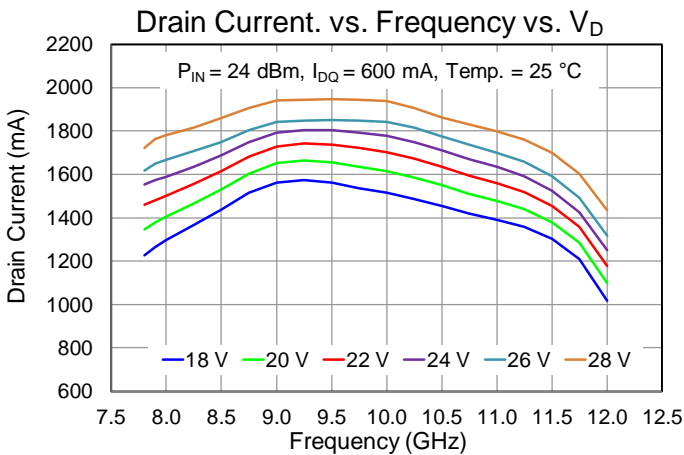
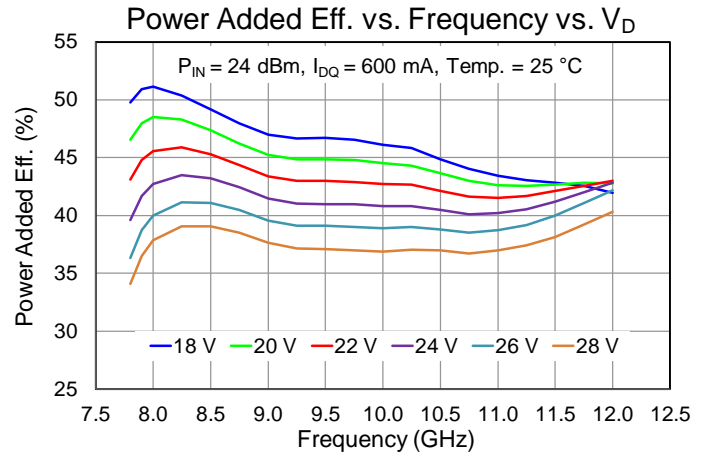
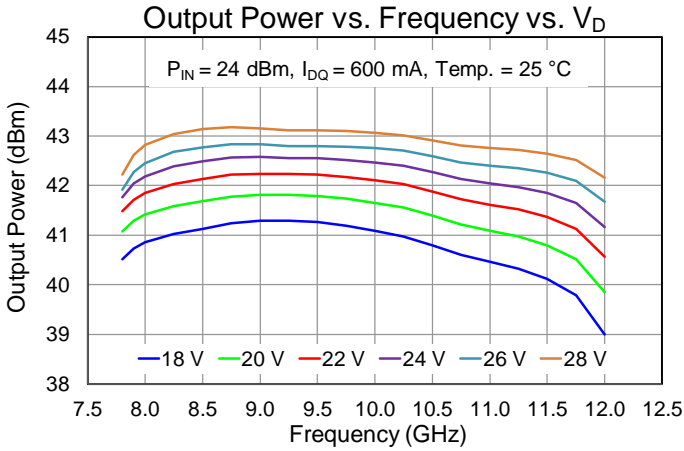

Performance Plots – Large Signal (CW)

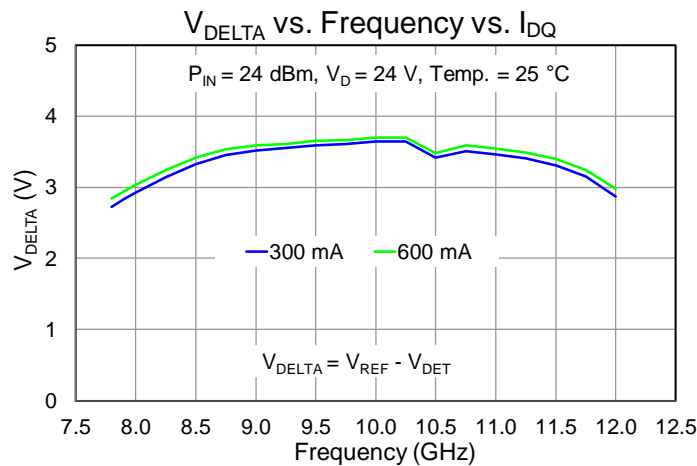
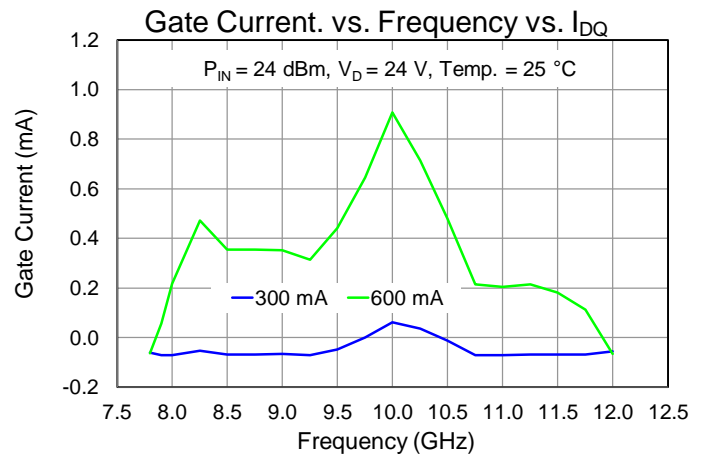
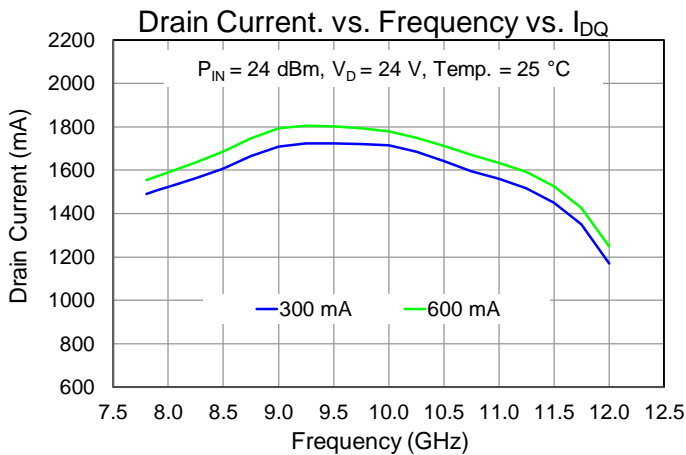
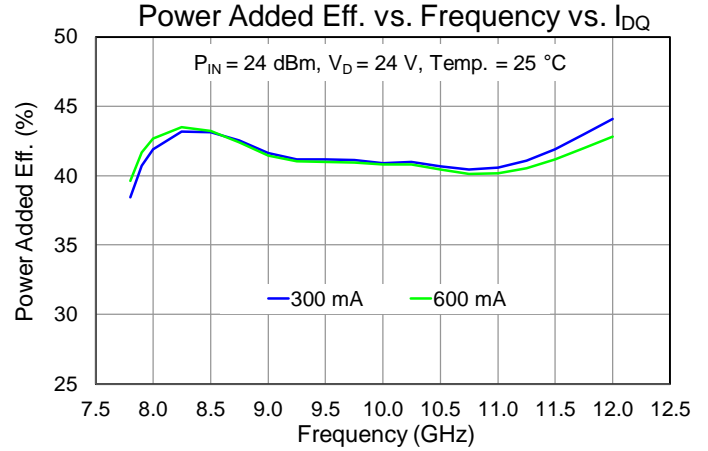
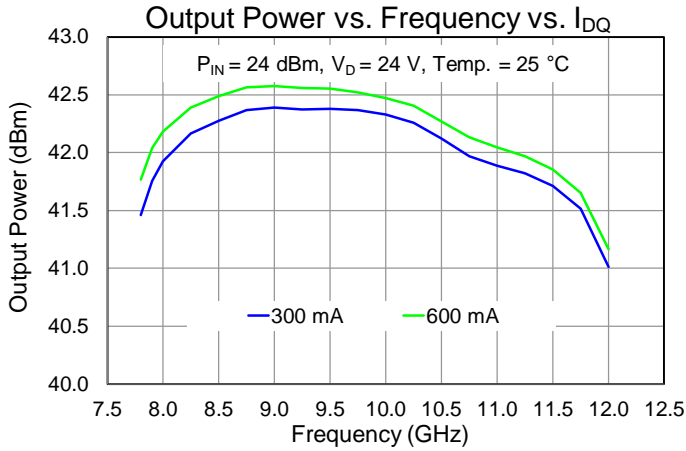

Performance Plots – Large Signal (CW)

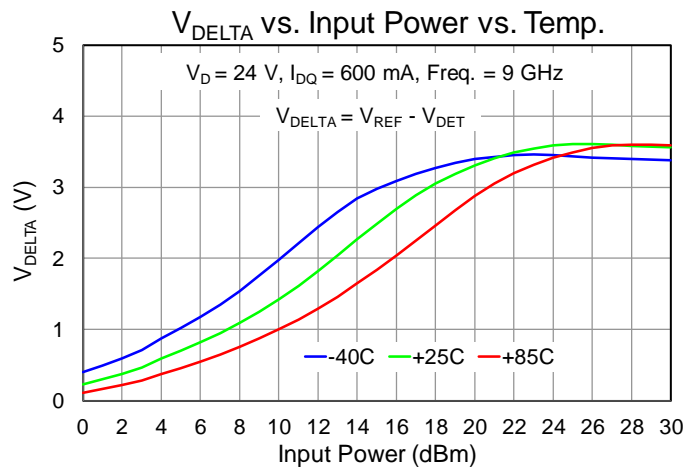
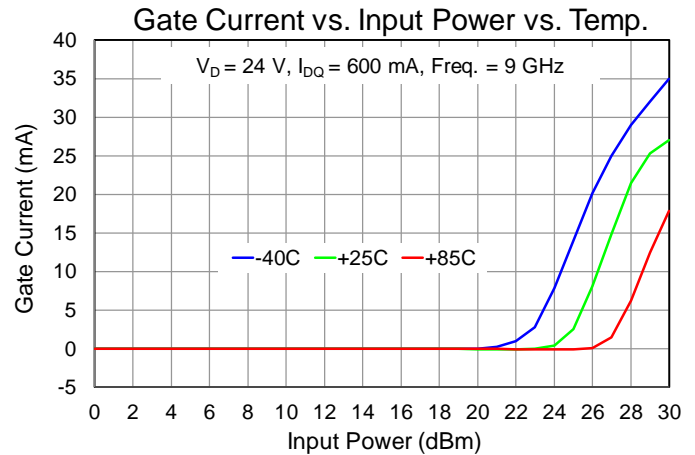
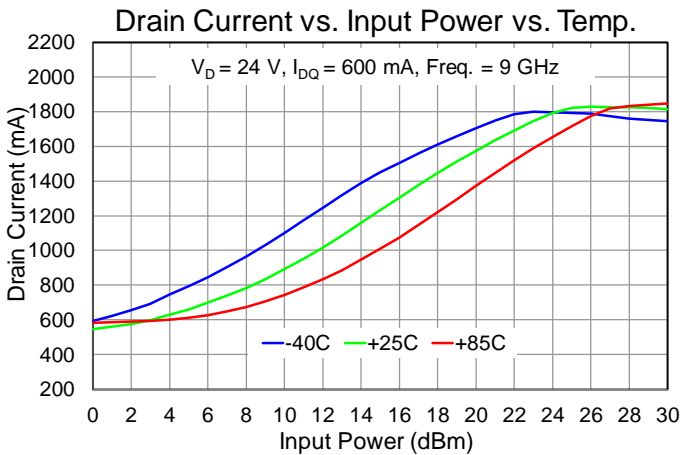
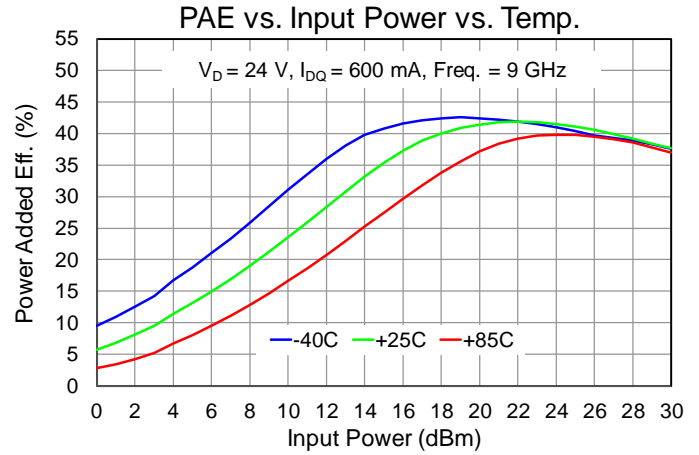
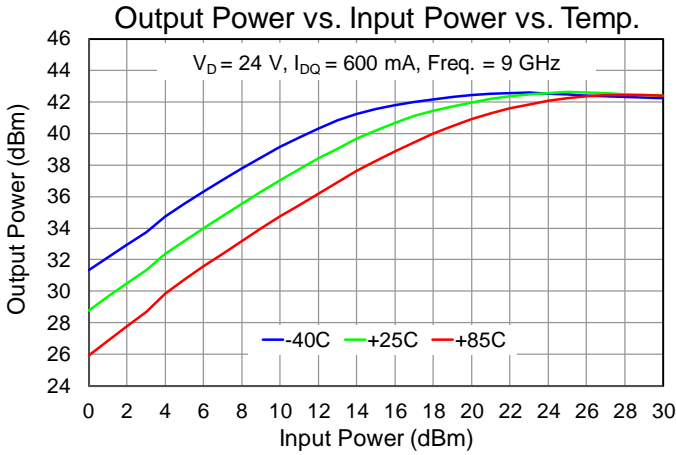

Performance Plots – Large Signal (CW)

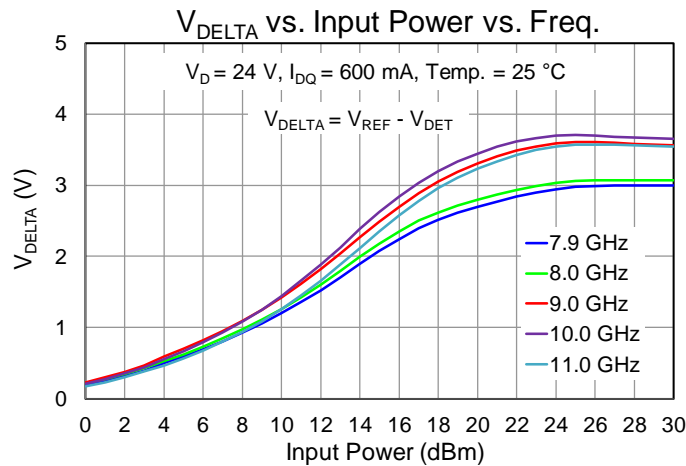
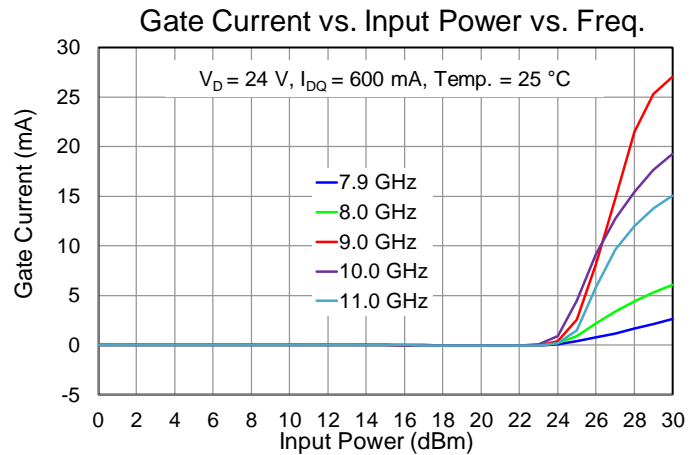
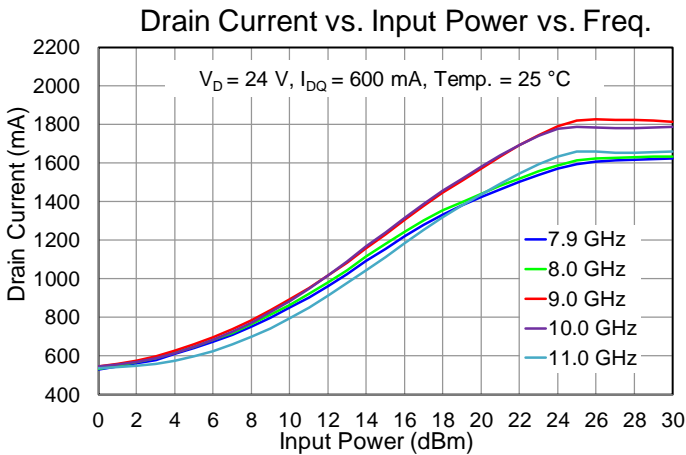
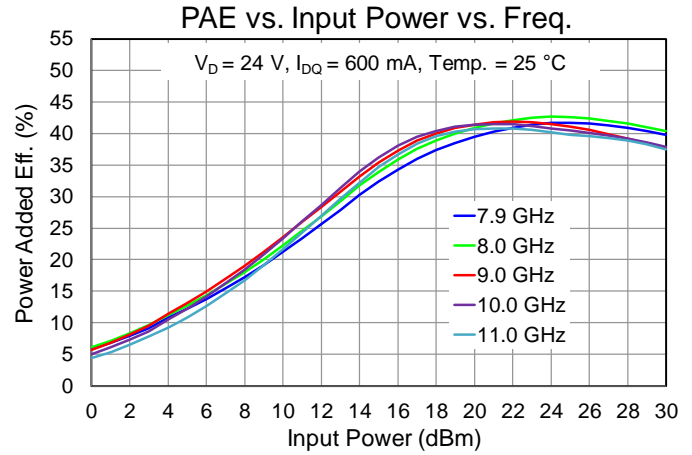
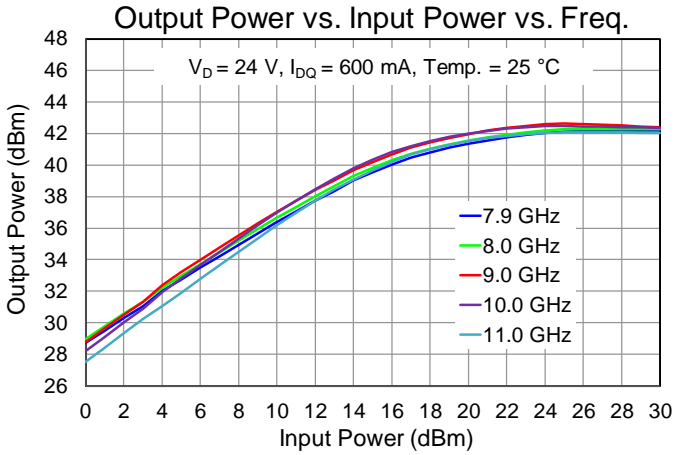

Performance Plots – Large Signal (CW)

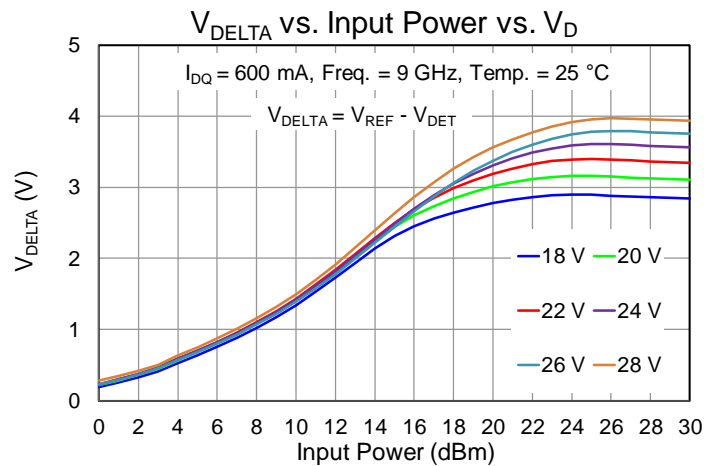
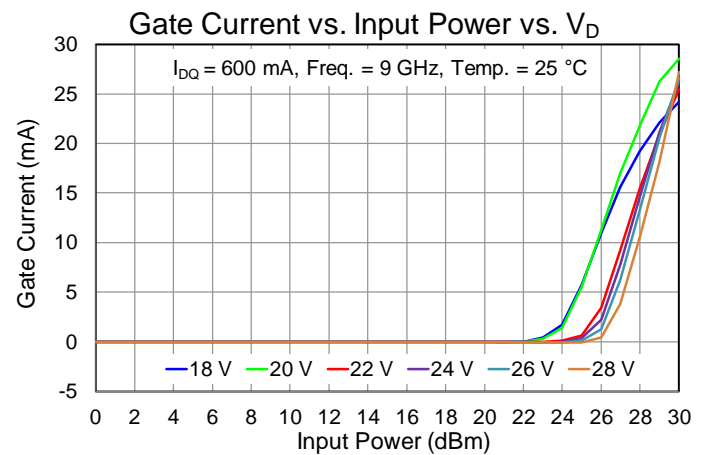
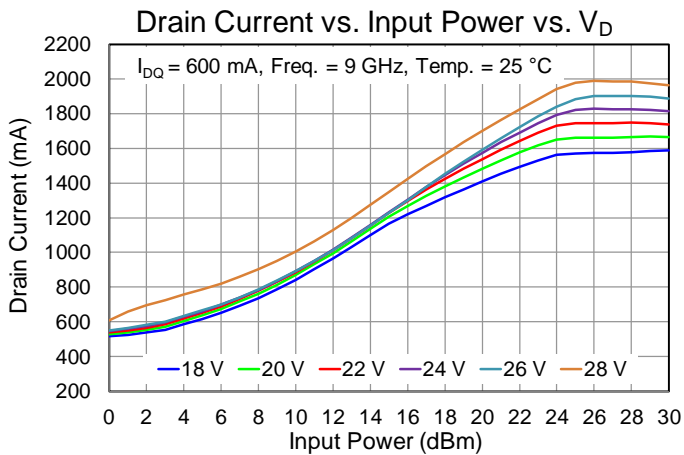
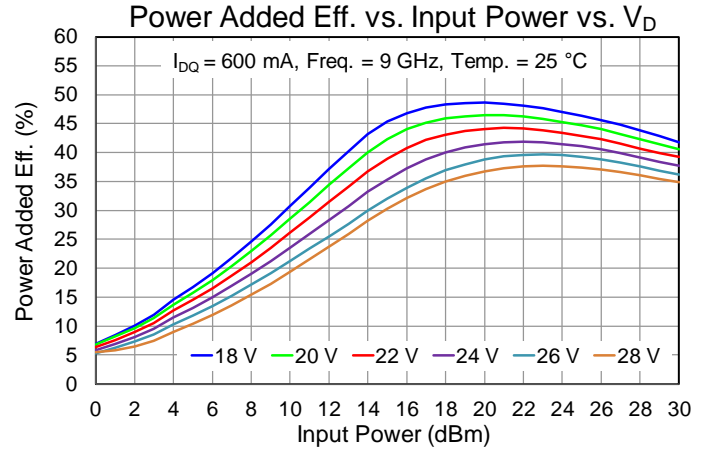
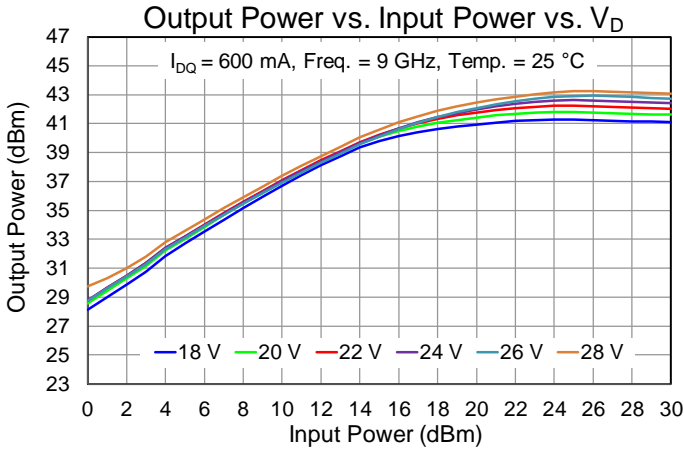

Performance Plots – Linearity

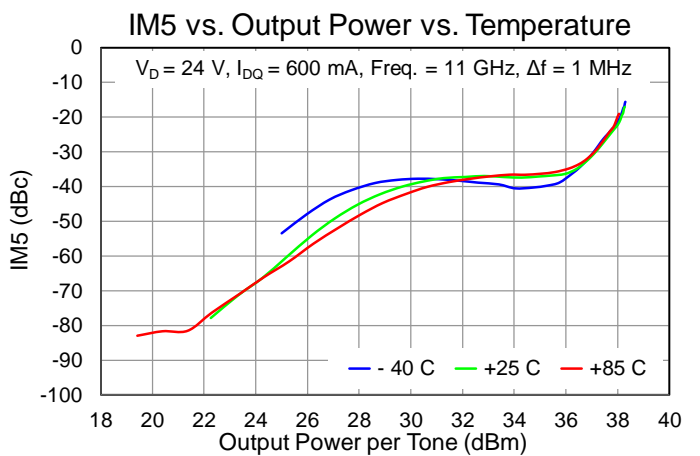
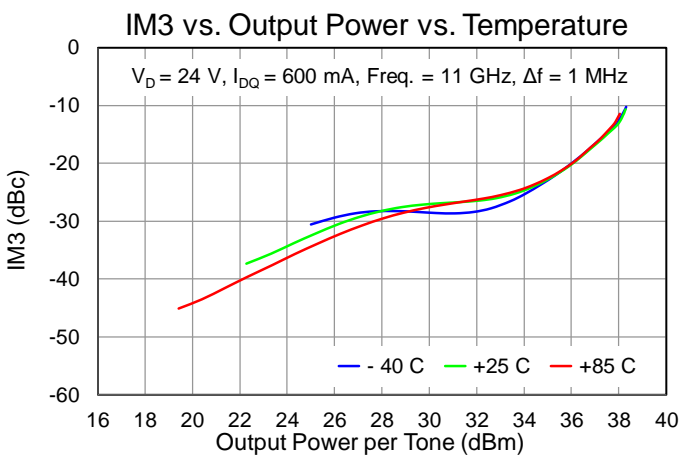
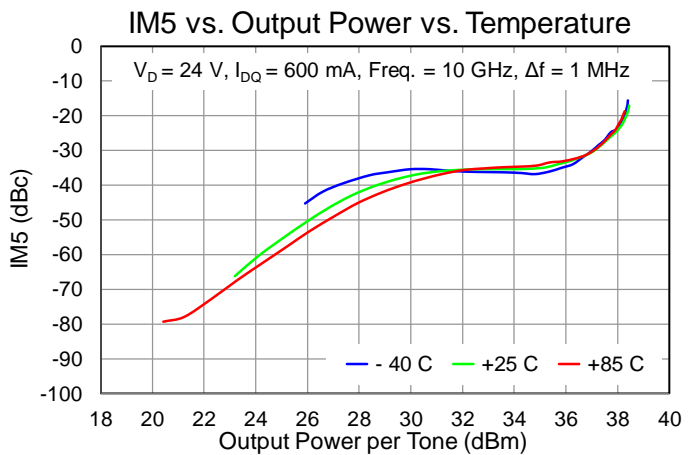
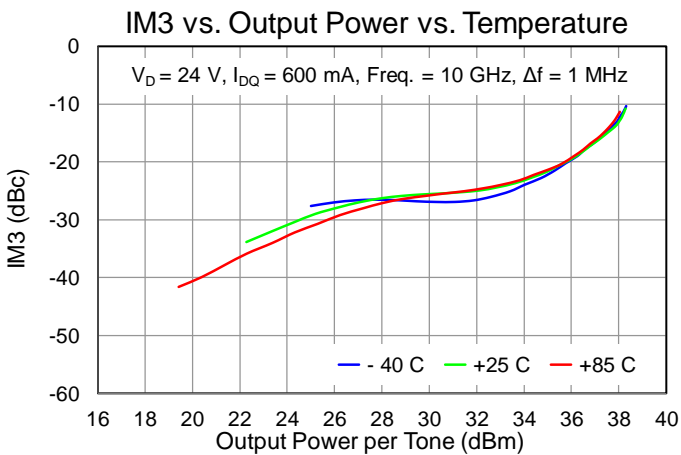
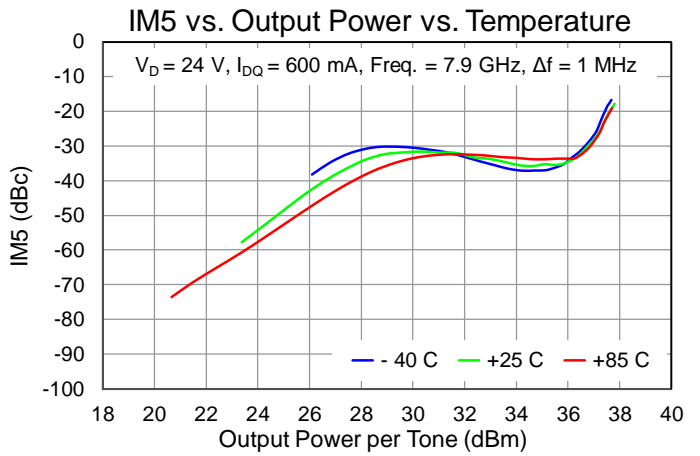
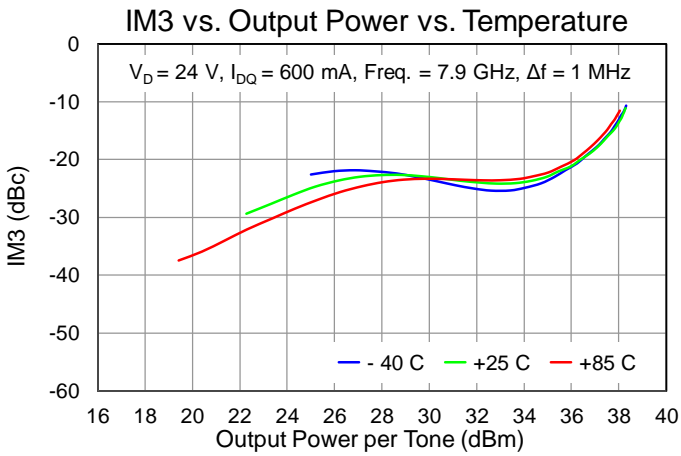

Performance Plots – Linearity

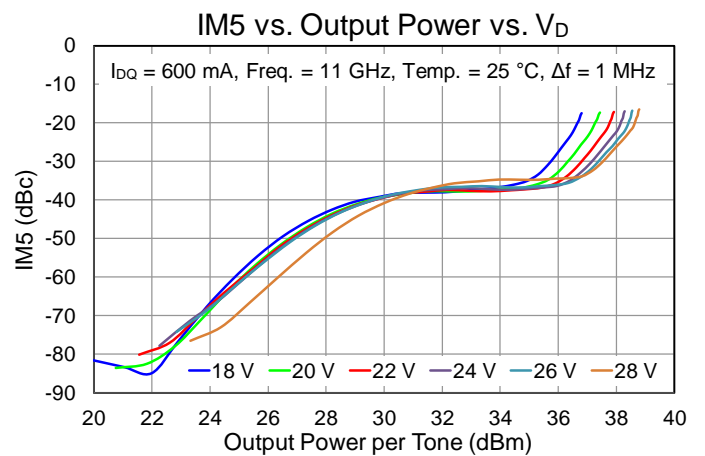
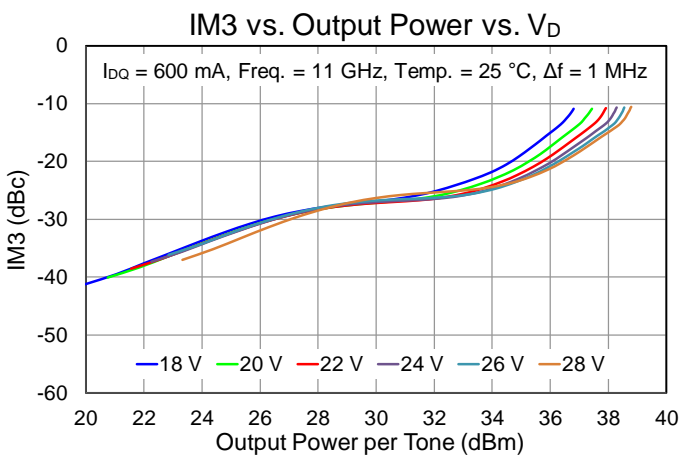
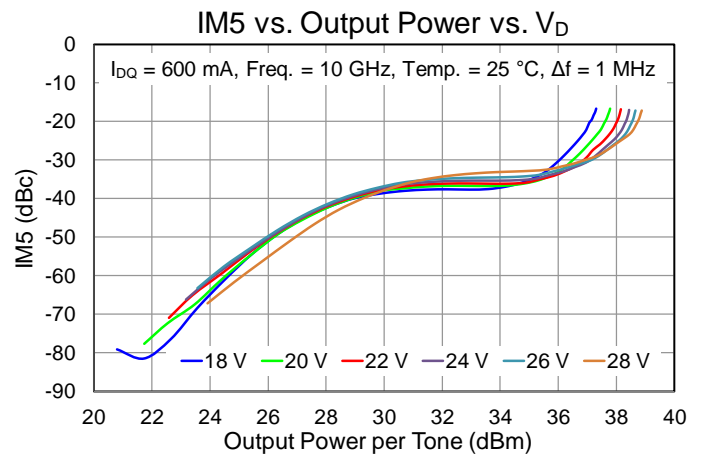
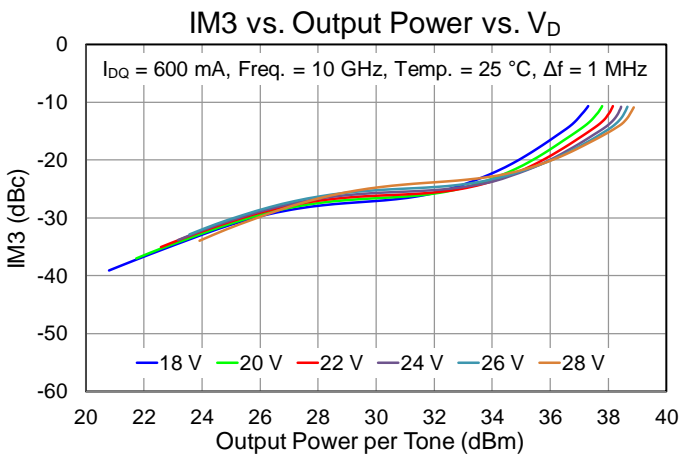
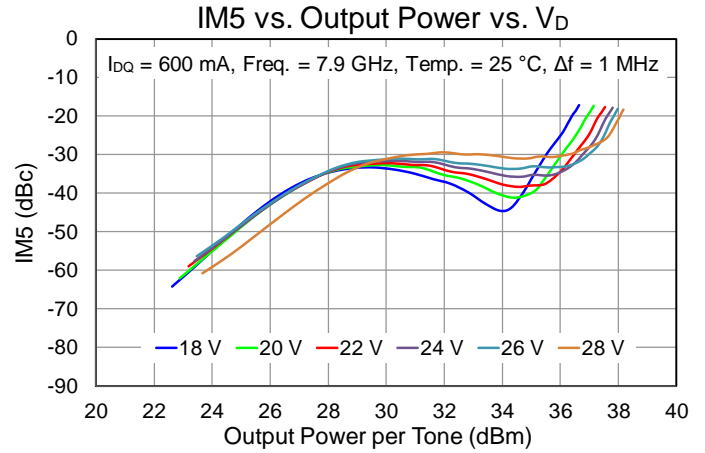
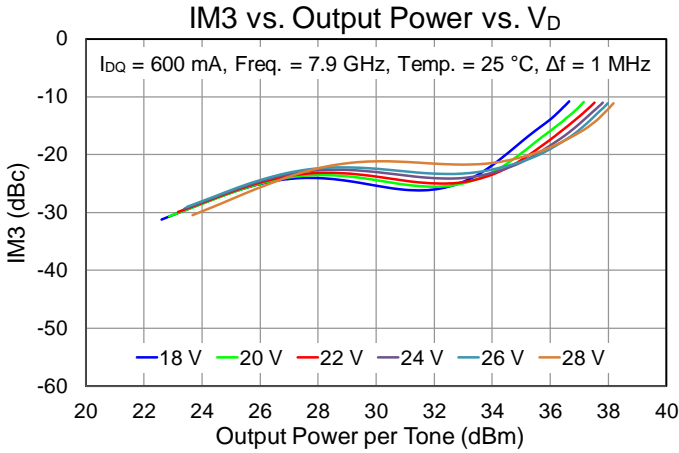

Performance Plots – Linearity

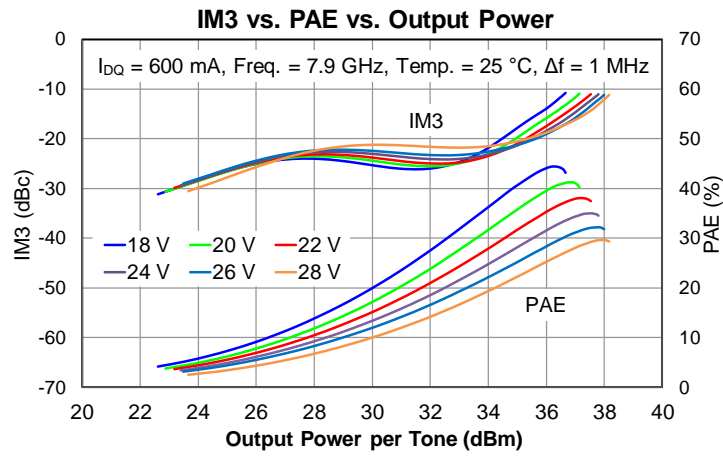

Performance Plots – Harmonics

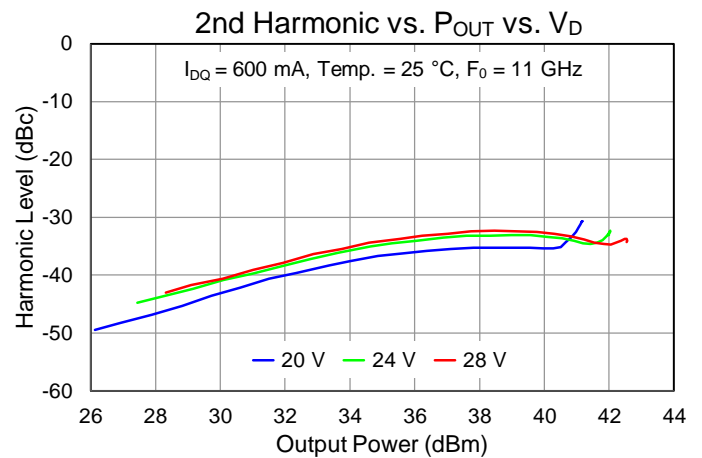
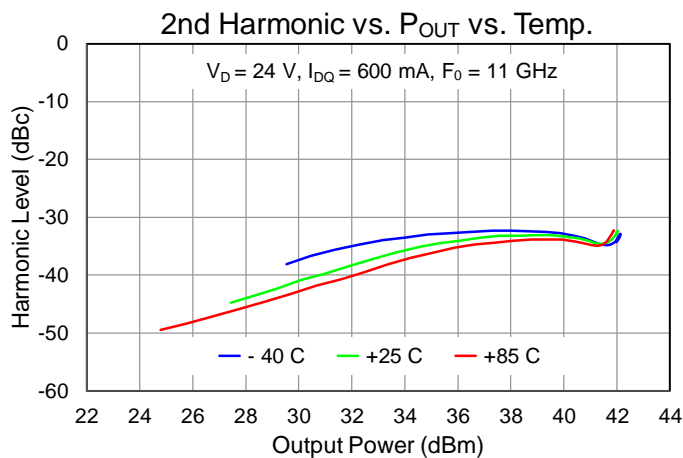
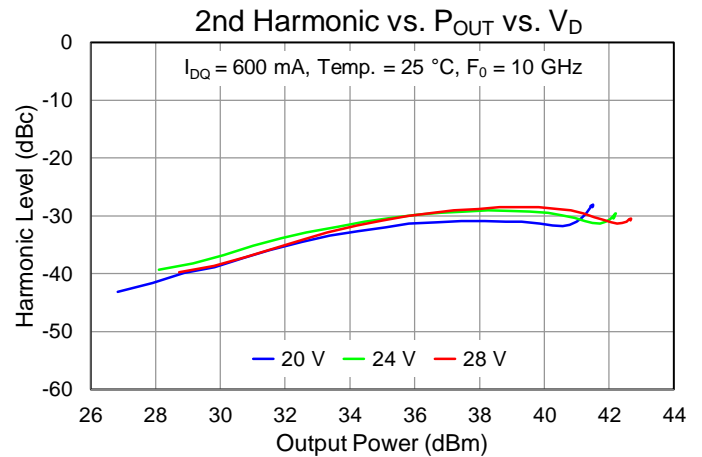
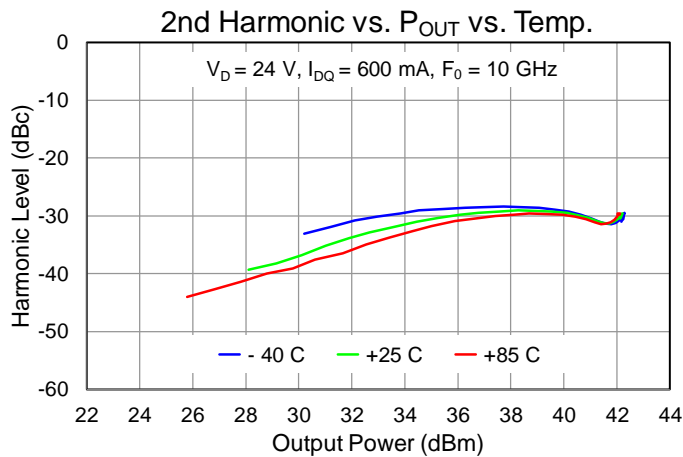
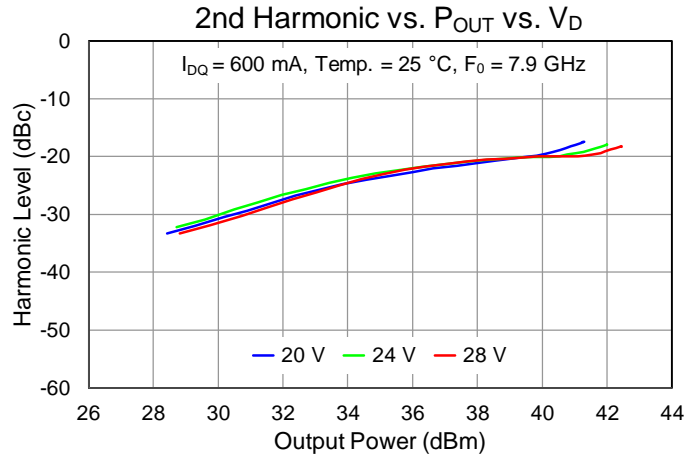
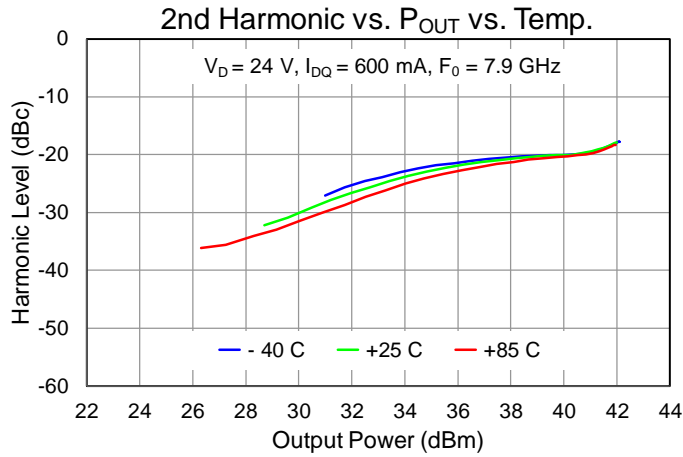

Performance Plots – Small Signal

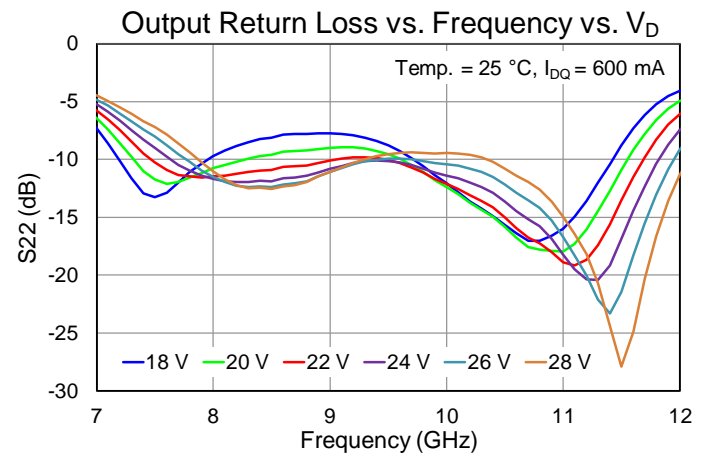
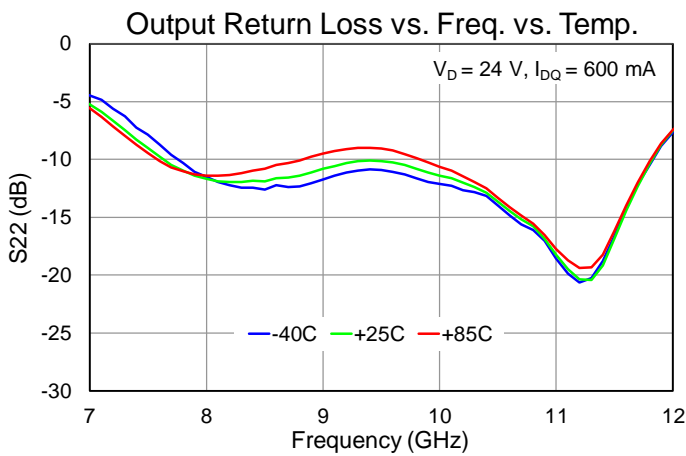
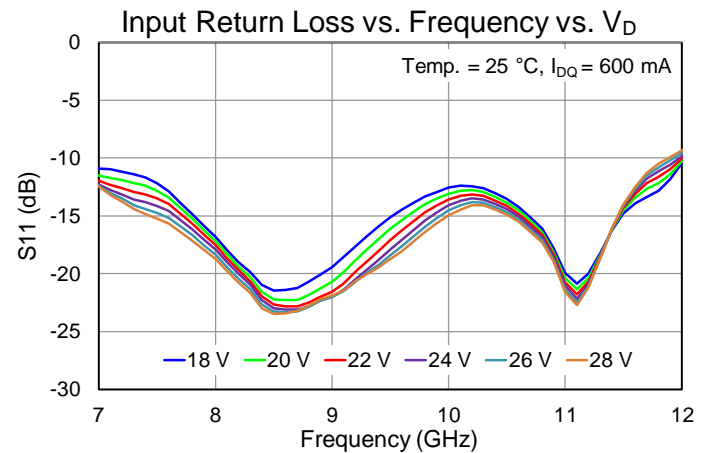
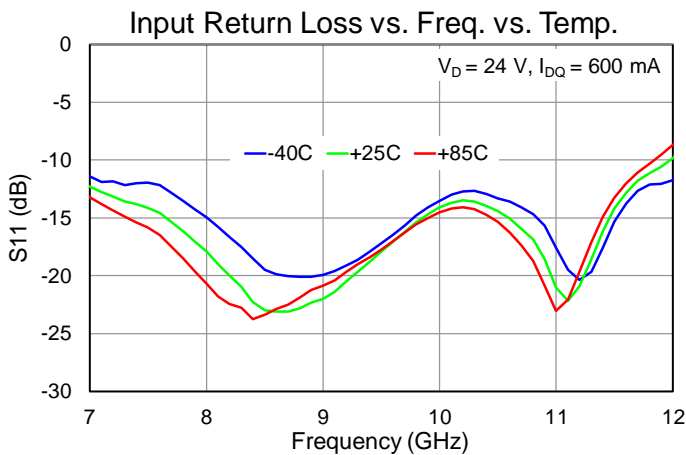
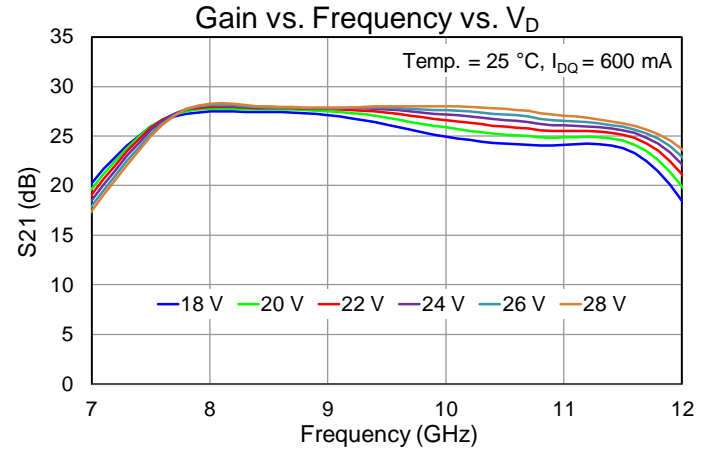
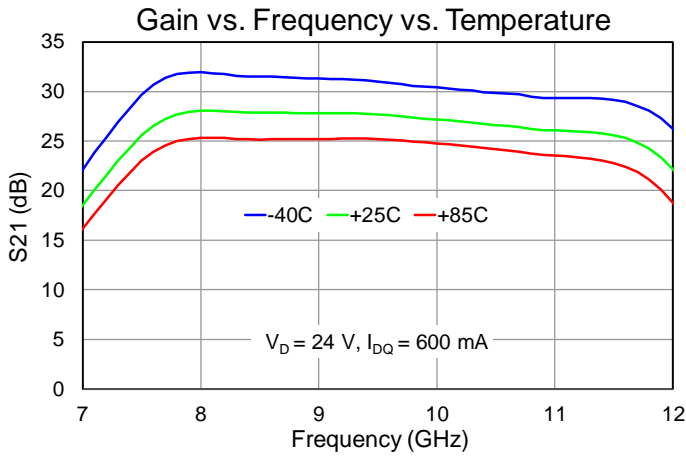

Performance Plots – Small Signal

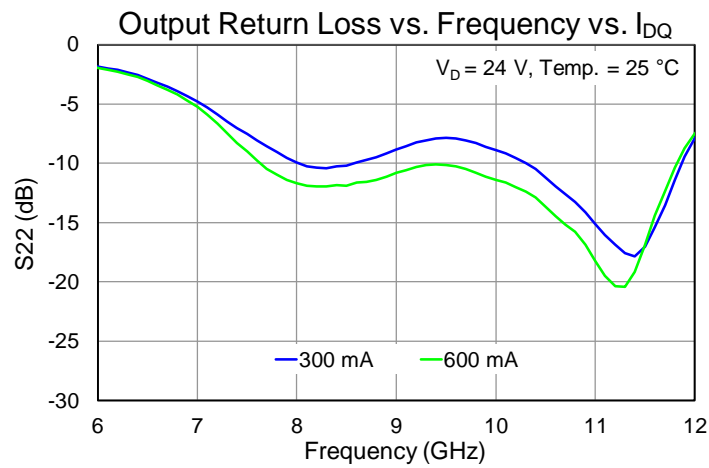
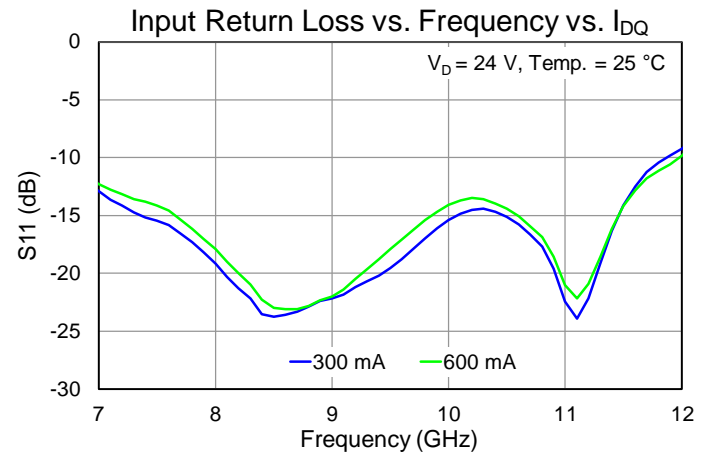
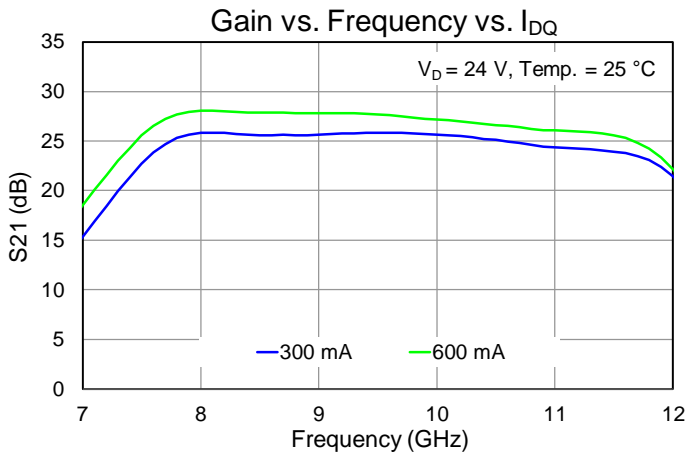

Thermal and Reliability Information

Parameter	Test Conditions	Value	Units
Thermal Resistance (θ_{JC}) ⁽¹⁾	$T_{BASE} = 85^\circ\text{C}$, $V_D = +24\text{ V}$, $I_{DQ} = 600\text{ mA}$, Pulsed V_D (100 $\mu\text{s}/10\%$), Freq = 9.25 GHz, $P_{IN} = 24\text{ dBm}$, $I_{D_Drive} = 1.7\text{ A}$, $P_{OUT} = 42\text{ dBm}$, $P_{DISS} = 25.9\text{ W}$	2.503	$^\circ\text{C}/\text{W}$
Channel Temperature (T_{CH}) (Under RF drive) ⁽²⁾		149.8	$^\circ\text{C}$
Thermal Resistance (θ_{JC}) ⁽¹⁾	$T_{BASE} = 85^\circ\text{C}$, $V_D = +24\text{V}$, $I_{DQ} = 600\text{ mA}$, CW, $P_{DISS} = 14.4\text{ W}$	2.860	$^\circ\text{C}/\text{W}$
Channel Temperature (T_{CH}) (No RF) ⁽²⁾		126.2	$^\circ\text{C}$
Thermal Resistance (θ_{JC}) ⁽¹⁾	$T_{BASE} = 85^\circ\text{C}$, $V_D = +24\text{ V}$, $I_{DQ} = 600\text{ mA}$, CW, Freq = 9.25 GHz, $P_{IN} = 24\text{ dBm}$, $I_{D_Drive} = 1.7\text{ A}$, $P_{OUT} = 42\text{ dBm}$, $P_{DISS} = 24.2\text{ W}$	2.704	$^\circ\text{C}/\text{W}$
Channel Temperature (T_{CH}) (Under RF drive) ⁽²⁾		150.4	$^\circ\text{C}$
Thermal Resistance (θ_{JC}) ⁽¹⁾	$T_{BASE} = 85^\circ\text{C}$, $V_D = +20\text{ V}$, $I_{DQ} = 600\text{ mA}$, Pulsed V_D (100 $\mu\text{s}/10\%$), Freq = 9.25 GHz, $P_{IN} = 24\text{ dBm}$, $I_{D_Drive} = 1.6\text{ A}$, $P_{OUT} = 41.3\text{ dBm}$, $P_{DISS} = 18.5\text{ W}$	1.896	$^\circ\text{C}/\text{W}$
Channel Temperature (T_{CH}) (Under RF drive) ⁽²⁾		120.1	$^\circ\text{C}$
Thermal Resistance (θ_{JC}) ⁽¹⁾	$T_{BASE} = 85^\circ\text{C}$, $V_D = +20\text{V}$, $I_{DQ} = 600\text{ mA}$, CW, $P_{DISS} = 12\text{ W}$	2.807	$^\circ\text{C}/\text{W}$
Channel Temperature (T_{CH}) (No RF) ⁽²⁾		118.7	$^\circ\text{C}$
Thermal Resistance (θ_{JC}) ⁽¹⁾	$T_{BASE} = 85^\circ\text{C}$, $V_D = +20\text{ V}$, $I_{DQ} = 600\text{ mA}$, CW, Freq = 9.25 GHz, $P_{IN} = 24\text{ dBm}$, $I_{D_Drive} = 1.56\text{ A}$, $P_{OUT} = 41.4\text{ dBm}$, $P_{DISS} = 17.7\text{ W}$	2.552	$^\circ\text{C}/\text{W}$
Channel Temperature (T_{CH}) (Under RF drive) ⁽²⁾		130.2	$^\circ\text{C}$

Notes:

1. Thermal resistance is referenced to the package backside T_{BASE}
2. IR scan equivalent. Refer to the following document: [GaN Device Channel Temperature, Thermal Resistance, and Reliability Estimates](#)

Power Dissipation and Maximum Gate Current

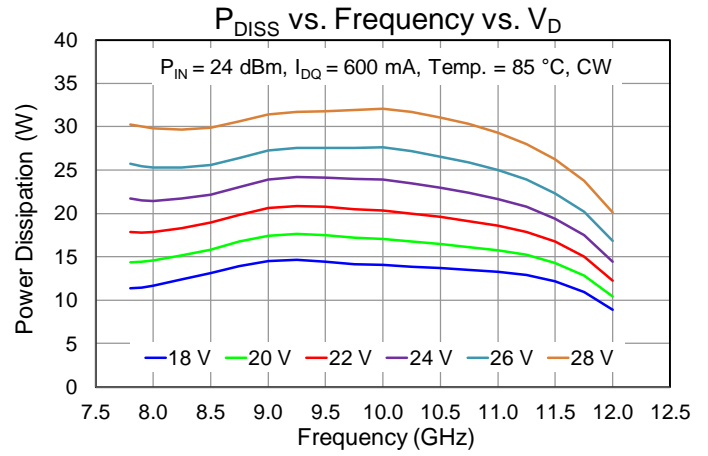
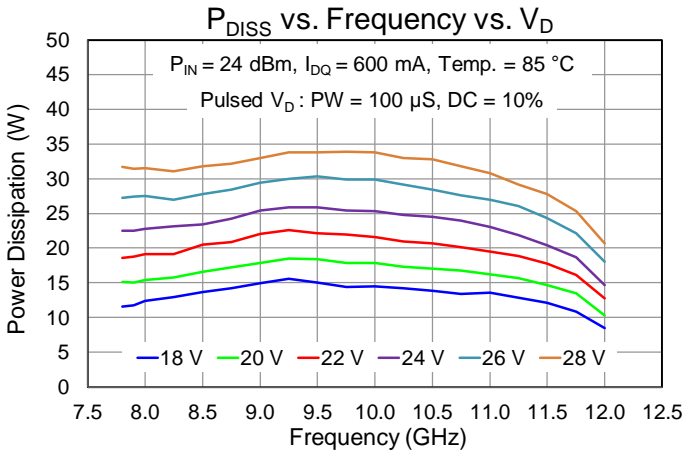

QPA1010 I_{g_max} vs. T_{CH} vs. Stage

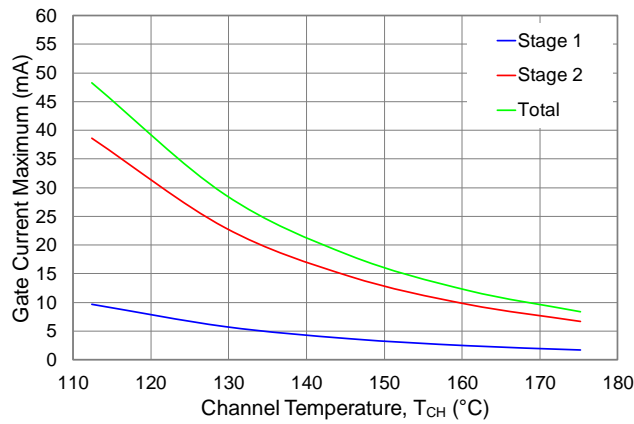

Applications Circuit for Linear and Pulsed Operations

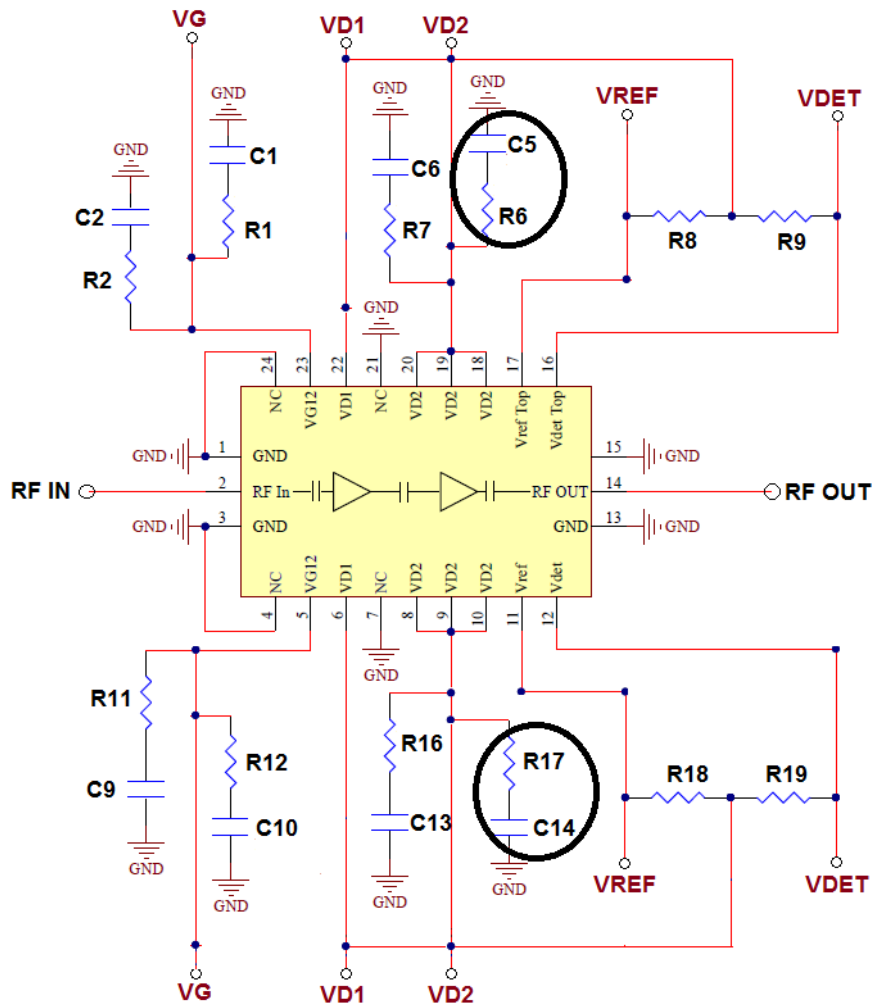

Note: $V_{\Delta} = V_{REF} - V_{DET}$

- QPA1010 can be biased from either the top side or bottom side.
- V_{D1} and V_{D2} need to be tied together.
- V_{D1} / V_{D2} and V_{REF} / V_{DET} have to be on the same side for V_{Δ} to work.
- Bypassing components required for the side(s) being biased.
- The extra bias components (R6, R17, C5 and C14) are required for optimum linearity.

Bias Up Procedure

1. Set I_D limit to 2000 mA, I_G limit to 20 mA
2. Apply -5 V to V_G
3. Apply +24 V to V_D ; ensure I_{DQ} is approx. 0 mA
4. Adjust V_G until $I_{DQ} = 600$ mA ($V_G \sim -1.8$ V Typ.).
5. Turn on RF supply

Bias Down Procedure

1. Turn off RF supply
2. Reduce V_G to -5 V; ensure I_{DQ} is approx. 0 mA
3. Set V_D to 0 V
4. Turn off V_D supply
5. Turn off V_G supply

Evaluation Board (EVB) Layout Assembly for Pulsed Operation

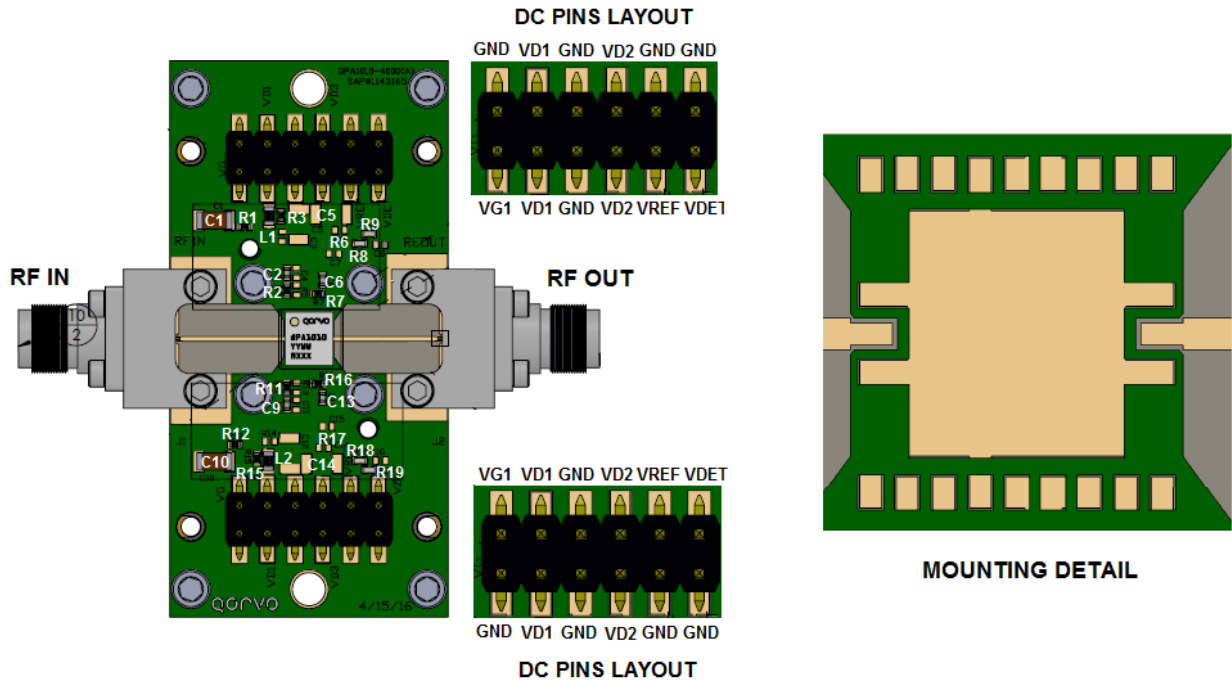

Note: PCB is a multilayer

1. All 4 metal thicknesses are 0.5 oz
2. Upper core 1 is Rogers 4003C, 8 mil thick
3. Lower core 2 is 370HR, 6 mil thick
4. Prepreg is an epoxy coated glass fabric
5. Total finished PCB thickness is 25 ±3 mil
6. This EVB uses a copper-coined PCB for optimum thermal management under high dissipation long pulse and/or CW conditions

Bill of Materials for EVB

Reference Des.	Value	Description	Manuf.	Part Number
C1, C5, C10, C14	10 uF	CAP, 1206, 50 V, 20 %, X5R	Various	–
C2, C6, C9, C13	0.01 uF	CAP, 0402, 50 V, 10 %, X7R	Various	–
R1, R12	5.1 Ohm	RES, 0402, 50V, 5 %, SMT	Various	–
R2, R3, R6, R7, R11, R15, R16, R17 ⁽¹⁾	0 Ohm	RES, 0402, 5 %, SMD	Various	–
R8, R9, R18, R19	25.5 K Ohm	RES, 0402, 1/16W, 1%, 0402	Various	–
L1, L2 ⁽¹⁾	0 Ohm	RES, 0603, 1/10 W	Various	–

Note:

1. These components are acting as the jumpers for this EVB.

Mechanical Information

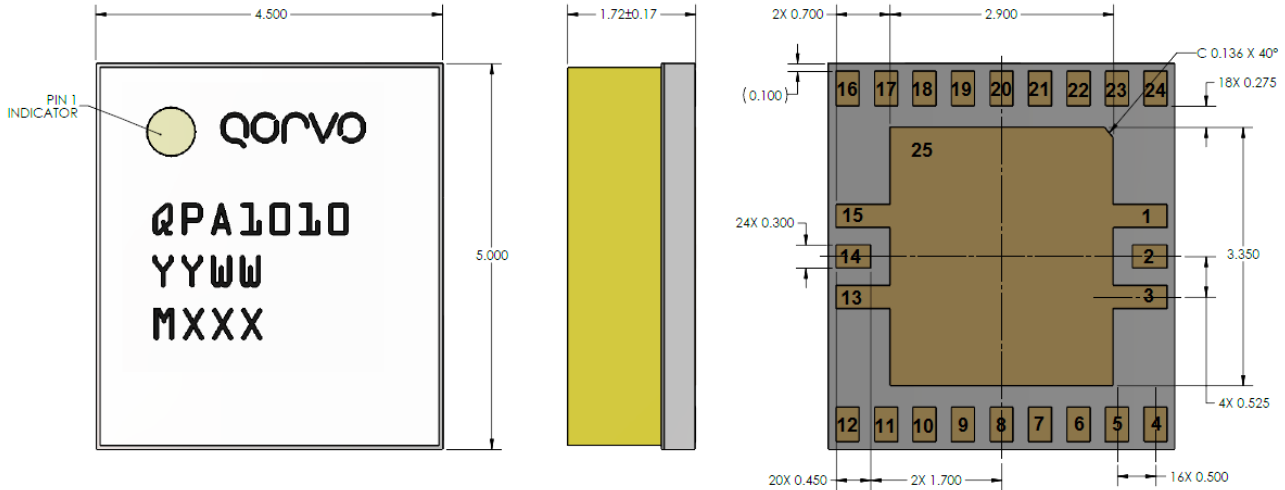

Units: millimeters
 Tolerances: unless specified
 x.xx = ± 0.25
 x.xxx = ± 0.100
 Materials:
 Base: Laminate
 Lid: FR4
 All metalized features are gold plated
 Part is epoxy sealed
 Marking:
 QPA1010: Part number
 YY: Part Assembly year
 WW: Part Assembly week
 MXXX: Batch ID

Pin Description

Pad No.	Symbol	Description
1, 3, 13, 15, 25 (pad)	GND	Ground. Must be grounded on the PCB. Conductive filled vias recommended for least inductance and improved thermal performance
2	RF _{IN}	RF Input; matched to 50 Ω; DC blocked
4, 7, 21, 24	N/C	Not connected internally. Recommended to be grounded
5, 23	V _{G1-2}	Stage 1-2 Gate Voltage. Bias network is required; see recommended Application Information above on page 22
6, 22	V _{D1}	Stage 1 Drain Voltage. Bias network is required; see recommended Application Information above on page 22
8 – 10, 18 - 20	V _{D2}	Stage 2 Drain voltage; Bias network is required; see recommended Application Information above on page 22
11, 17	V _{REF}	Reference voltage
12, 16	V _{DET}	Detector voltage
14	RF _{OUT}	RF Output; matched to 50 Ω; DC blocked

Assembly Notes

Compatible with lead-free soldering processes with 260°C peak reflow temperature.

This package is air-cavity and non-hermetic, and therefore cannot be subjected to aqueous washing. The use of no-clean solder to avoid washing after soldering is highly recommended.

Contact plating: Ni-Au

Solder rework not recommended

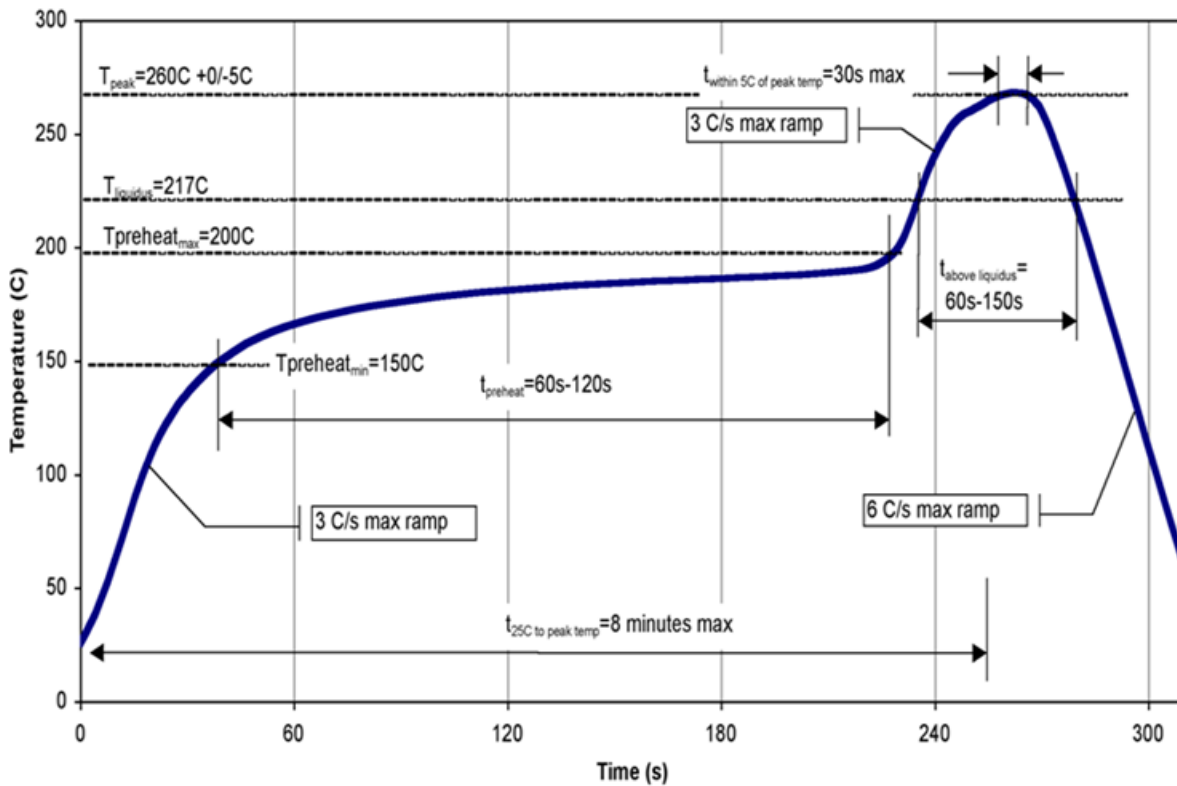

Recommended Soldering Temperature Profile

Handling Precautions

Parameter	Rating	Standard
ESD – Human Body Model (HBM)	0B	ANSI/ESDA / JEDEC JS-001
ESD – Charged Device Model (CDM)	C3	ANSI/ESDA / JEDEC JS-002
MSL – Convection Reflow 260 °C	3	JEDEC standard IPC/JEDEC J-STD-020



Caution!
ESD-Sensitive Device

RoHS Compliance

This product is compliant with the 2011/65/EU RoHS directive (Restrictions on the Use of Certain Hazardous Substances in Electrical and Electronic Equipment), as amended by Directive 2015/863/EU. This product also has the following attributes:

- Lead Free
- Antimony Free
- TBBP-A (C₁₅H₁₂Br₄O₂) Free

Contact Information

For the latest specifications, additional product information, worldwide sales and distribution locations:

Web: www.qorvo.com

Tel: 1-844-890-8163

Email: customer.support@qorvo.com

Important Notice

The information contained herein is believed to be reliable; however, Qorvo makes no warranties regarding the information contained herein and assumes no responsibility or liability whatsoever for the use of the information contained herein. All information contained herein is subject to change without notice. Customers should obtain and verify the latest relevant information before placing orders for Qorvo products. The information contained herein or any use of such information does not grant, explicitly or implicitly, to any party any patent rights, licenses, or any other intellectual property rights, whether with regard to such information itself or anything described by such information. **THIS INFORMATION DOES NOT CONSTITUTE A WARRANTY WITH RESPECT TO THE PRODUCTS DESCRIBED HEREIN, AND QORVO HEREBY DISCLAIMS ANY AND ALL WARRANTIES WITH RESPECT TO SUCH PRODUCTS WHETHER EXPRESS OR IMPLIED BY LAW, COURSE OF DEALING, COURSE OF PERFORMANCE, USAGE OF TRADE OR OTHERWISE, INCLUDING THE IMPLIED WARRANTIES OF MERCHANTABILITY AND FITNESS FOR A PARTICULAR PURPOSE.**

Without limiting the generality of the foregoing, Qorvo products are not warranted or authorized for use as critical components in medical, life-saving, or life-sustaining applications, or other applications where a failure would reasonably be expected to cause severe personal injury or death.

Copyright 2021 © Qorvo, Inc. | Qorvo is a registered trademark of Qorvo, Inc.

Mouser Electronics

Authorized Distributor

Click to View Pricing, Inventory, Delivery & Lifecycle Information:

[Qorvo:](#)

[QPA1010](#) [QPA1010PCB4B01](#) [QPA1010TR7](#)