



Features

- 50MHz to 1000MHz Operation
- Internally Matched Input and Output
- 20dB Small Signal Gain
- 1.5dB Noise Figure
- +24dBm Output Power
- Single 5V to 9V Positive Power Supply

Applications

- CATV Distribution Amplifiers
- Cable Modems
- Broadband Gain Blocks
- Laser Diode Driver
- Return Channel Amplifier
- Base Stations

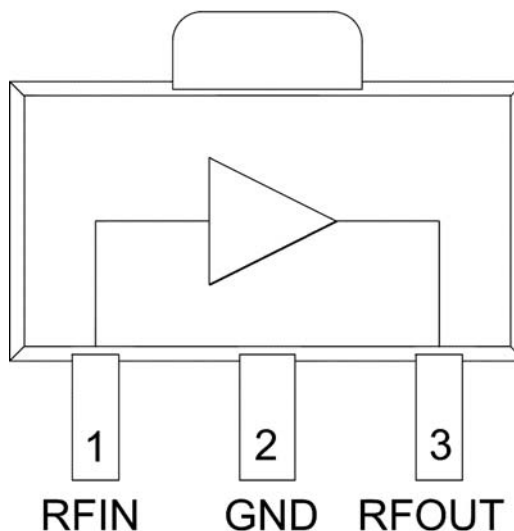

Functional Block Diagram

Product Description

The CXE-2089Z is a general purpose, low-cost, high-linearity RF amplifier IC. The device is manufactured on a Gallium Arsenide process and is featured in a small SOT-89 package. It has been designed for use as an easily cascadable 75Ω gain block with a noise figure of less than 2dB. Gain flatness better than 0.5dB from 50MHz to 1000MHz, and high linearity make this part ideal for cable TV applications. Other applications include IF and RF amplification in wireless voice and data communication products operating in the 50MHz to 1000MHz frequency range. The device is self-contained with 75Ω input and output impedances providing less than 2:1 VSWR matching. For higher input and output return losses, see the evaluation schematic.

Optimum Technology Matching® Applied

- | | | | |
|---|--------------------------------------|-------------------------------------|------------------------------------|
| <input type="checkbox"/> GaAs HBT | <input type="checkbox"/> SiGe BiCMOS | <input type="checkbox"/> GaAs pHEMT | <input type="checkbox"/> GaN HEMT |
| <input checked="" type="checkbox"/> GaAs MESFET | <input type="checkbox"/> Si BiCMOS | <input type="checkbox"/> Si CMOS | <input type="checkbox"/> BiFET HBT |
| <input type="checkbox"/> InGaP HBT | <input type="checkbox"/> SiGe HBT | <input type="checkbox"/> Si BJT | <input type="checkbox"/> LDMOS |

RF MICRO DEVICES®, RFMD®, Optimum Technology Matching®, Enabling Wireless Connectivity™, PowerStar®, POLARIS™ TOTAL RADIO™ and UltimateBlue™ are trademarks of RFMD, LLC. BLUETOOTH is a trademark owned by Bluetooth SIG, Inc., U.S.A. and licensed for use by RFMD. All other trade names, trademarks and registered trademarks are the property of their respective owners. ©2006, RF Micro Devices, Inc.

Absolute Maximum Ratings

Parameter	Rating	Unit
Device Current	175	mA
Device Voltage	9	V
Input RF Power	+10	dBm
Output Load VSWR	20:1	
Ambient Operating Temperature	-40 to +85*	°C
Storage Temperature	-40 to +150	°C

*Note: Case Temperature



Caution! ESD sensitive device.

Exceeding any one or a combination of the Absolute Maximum Rating conditions may cause permanent damage to the device. Extended application of Absolute Maximum Rating conditions to the device may reduce device reliability. Specified typical performance or functional operation of the device under Absolute Maximum Rating conditions is not implied.

The information in this publication is believed to be accurate and reliable. However, no responsibility is assumed by RF Micro Devices, Inc. ("RFMD") for its use, nor for any infringement of patents, or other rights of third parties, resulting from its use. No license is granted by implication or otherwise under any patent or patent rights of RFMD. RFMD reserves the right to change component circuitry, recommended application circuitry and specifications at any time without prior notice.



RFMD Green: RoHS compliant per EU Directive 2002/95/EC, halogen free per IEC 61249-2-21, < 1000ppm each of antimony trioxide in polymeric materials and red phosphorus as a flame retardant, and <2% antimony in solder.

Parameter	Specification			Unit	Condition
	Min.	Typ.	Max.		
Electrical Characteristics (75Ω)					T=25°C, V _{DD} =7V, I _{DD} =105mA, 75Ω System, P _{IN} =-8dBm
Frequency Range	50		1000	MHz	3dB Bandwidth
Gain		20		dB	50MHz to 1000MHz
Gain Flatness		±0.5		dB	50MHz to 1000MHz
Reverse Isolation		24		dB	50MHz to 1000MHz
Noise Figure		1.5		dB	500MHz
		1.5		dB	50MHz to 1000MHz
Output IP ₃		38.5		dBm	P _{OUT} =0dBm, 50MHz, 6MHz tone spacing
		36		dBm	P _{OUT} =0dBm, 500MHz, 6MHz tone spacing
		36		dBm	P _{OUT} =0dBm, 1000MHz, 6MHz tone spacing
Output IP ₂		50.1		dBm	P _{OUT} =0dBm, 50MHz, 55.25MHz tone spacing
		48		dBm	P _{OUT} =0dBm, 500MHz, 55.25MHz tone spacing
		45		dBm	P _{OUT} =0dBm, 1000MHz, 55.25MHz tone spacing
Output IP _{1dB}		23		dBm	P _{IN} =-8dBm, 50MHz
		23		dBm	P _{IN} =-8dBm, 500MHz
		22		dBm	P _{IN} =-8dBm, 1000MHz
Input Return Loss		13		dB	50MHz to 1000MHz
Output Return Loss		14		dB	50MHz to 1000MHz
CSO		65		dBc	55.25MHz to 550MHz, 110 CH, Flat Tilt, +20dBmV out
CTB		75		dBc	55.25MHz to 550MHz, 110 CH, Flat Tilt, +20dBmV out
XMOD		80		dBc	55.25MHz to 550MHz, 110 CH, Flat Tilt, +20dBmV out
Device Operating Voltage	6	7	8	V	
Device Operating Current		105		mA	
Thermal Resistance				°C/W	Junction to lead

Parameter	Specification			Unit	Condition
	Min.	Typ.	Max.		
Electrical Characteristics (50Ω)					T=25°C, V _{DD} =7V, I _{DD} =105mA, 50Ω System, P _{IN} =-8dBm
Frequency Range	50		1000	MHz	3dB Bandwidth
Gain	TBD	20	TBD	dB	50MHz to 1000MHz
Gain Flatness	TBD	±0.5	TBD	dB	50MHz to 1000MHz
Reverse Isolation	TBD	24	TBD	dB	50MHz to 1000MHz
Noise Figure	TBD	1.4	TBD	dB	500MHz
	TBD	1.5	TBD	dB	50MHz to 1000MHz
Output IP ₃	TBD	34.5	TBD	dBm	P _{OUT} =0dBm, 50MHz, 6MHz tone spacing
	TBD	33	TBD	dBm	P _{OUT} =0dBm, 500MHz, 6MHz tone spacing
	TBD	35	TBD	dBm	P _{OUT} =0dBm, 1000MHz, 6MHz tone spacing
Output IP ₂	TBD	46	TBD	dBm	P _{OUT} =0dBm, 50MHz, 156MHz tone spacing
	TBD	45	TBD	dBm	P _{OUT} =0dBm, 500MHz, 156MHz tone spacing
	TBD	42	TBD	dBm	P _{OUT} =0dBm, 1000MHz, 156MHz tone spacing
Output IP _{1dB}	TBD	23	TBD	dBm	P _{IN} =-8dBm, 50MHz
	TBD	23	TBD	dBm	P _{IN} =-8dBm, 500MHz
	TBD	22	TBD	dBm	P _{IN} =-8dBm, 1000MHz
Input Return Loss	TBD	11	TBD	dB	50MHz to 1000MHz
Output Return Loss	TBD	15	TBD	dB	50MHz to 1000MHz
Device Operating Voltage	6	7	8	V	
Device Operating Current		105		mA	
Thermal Resistance				°C/W	Junction to lead

Application Note

Due to design characteristics of the CXE-2089Z Linear Gain Amplifier, improvements in multi-tone distortion performance will be seen with increased operating current up to 130mA. Degradation in multi-tone distortion may be seen when operating at current levels below 105 mA.

Typical Performance Curves (75Ω)

XMOD
110 Channels + 20dBmV Output

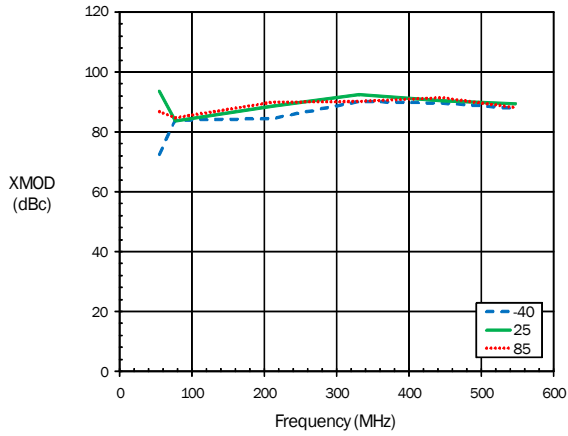

CTB
110 Channels + 20dBmV Output

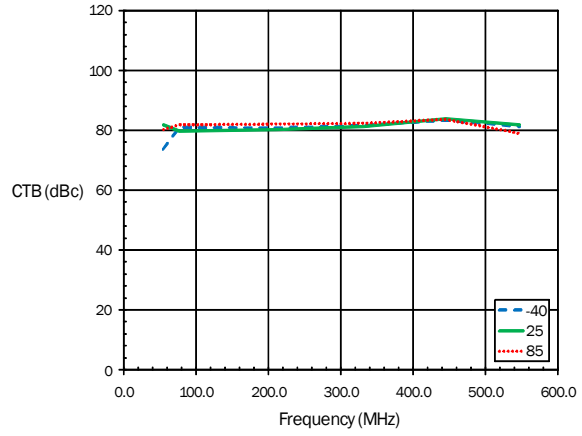

CSO (Upper)
110 Channels + 20dBmV Output

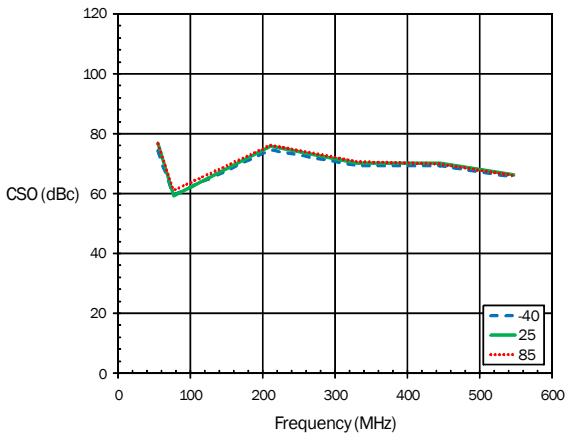

CSO (Lower)
110 Channels + 20dBmV Output

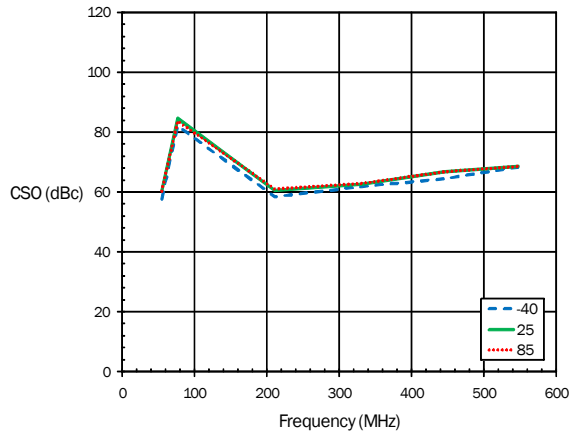

Input Return Loss

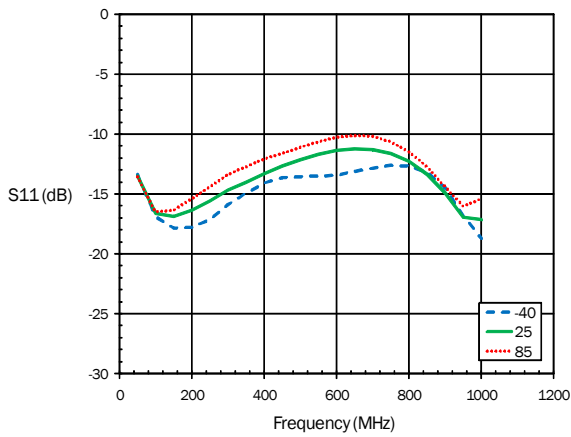

Output Return Loss

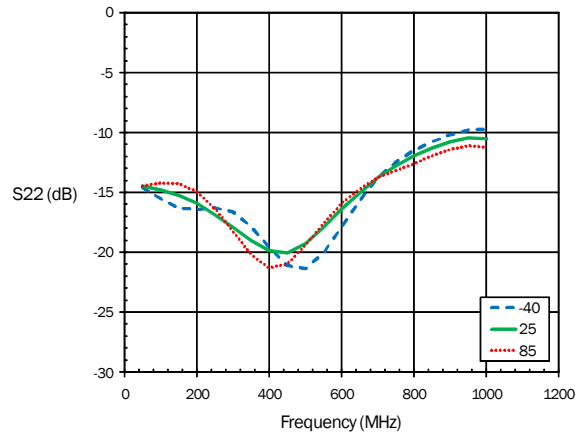

Typical Performance Curves (75Ω)

Reverse Isolation

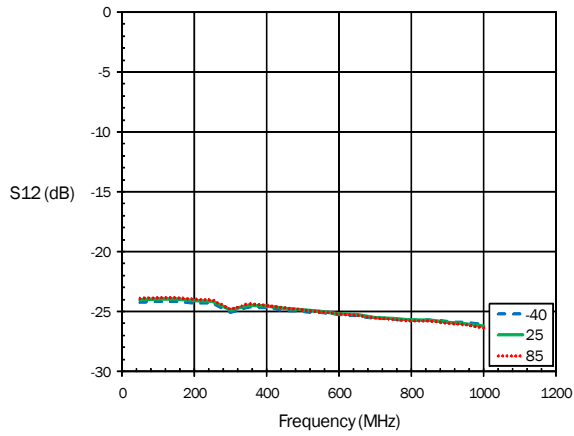

Gain

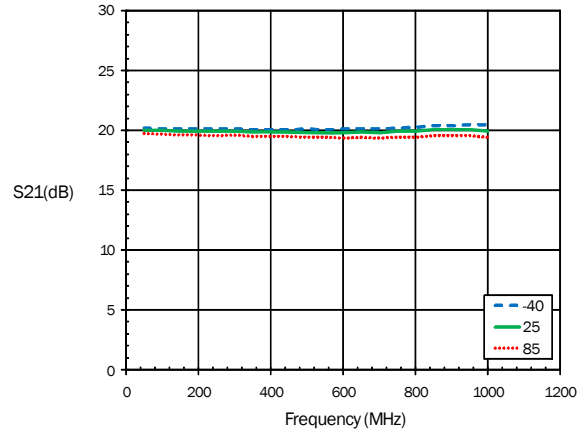

Noise Figure

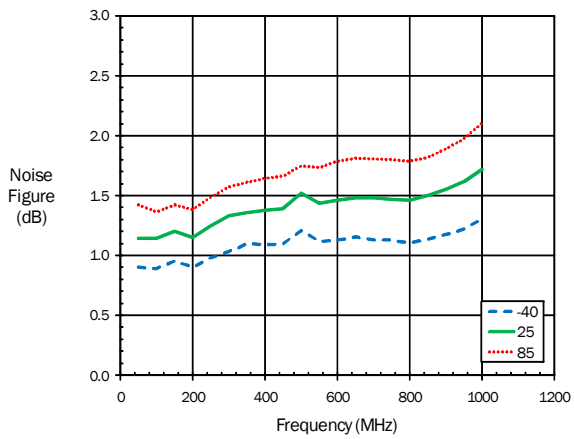

Output P1dB

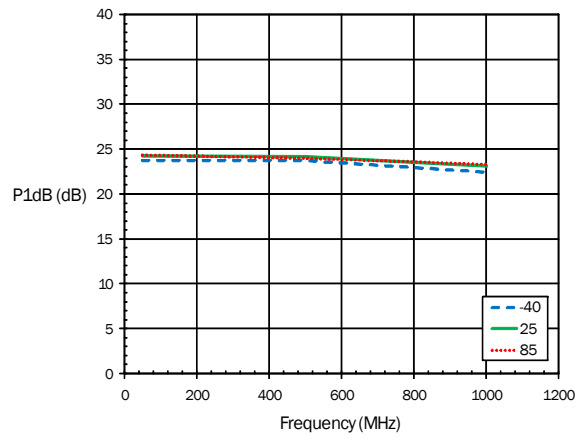

Output IP2

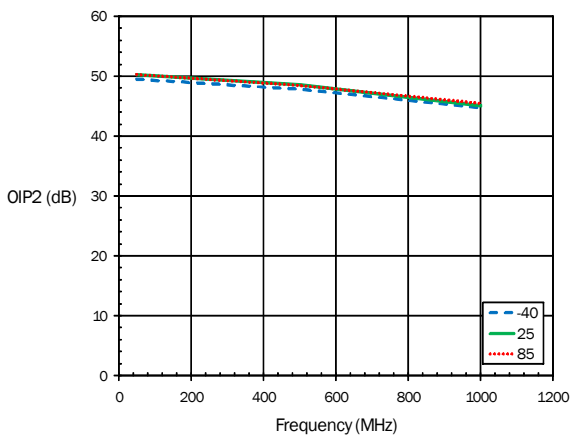

Output IP3

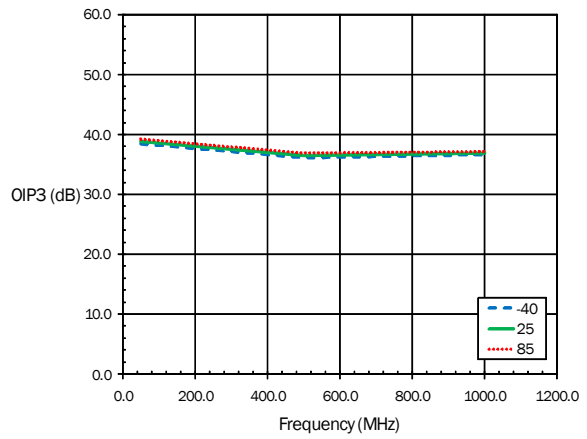

Typical Performance Curves (50Ω)

Input Return Loss

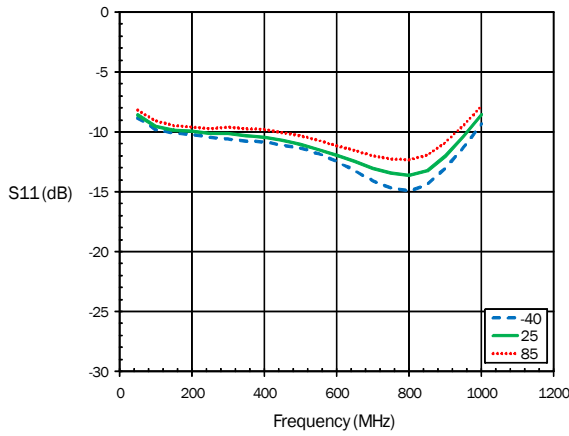

Output Return Loss

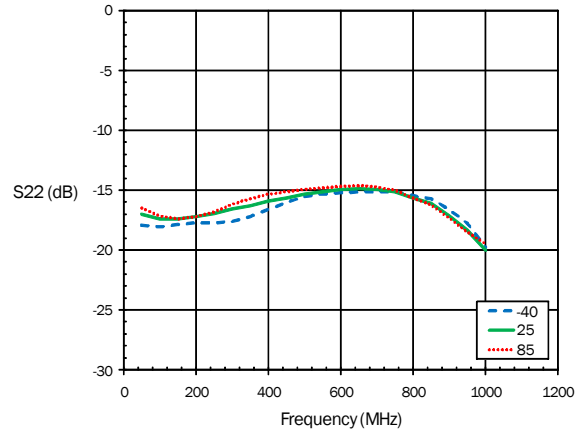

Reverse Isolation

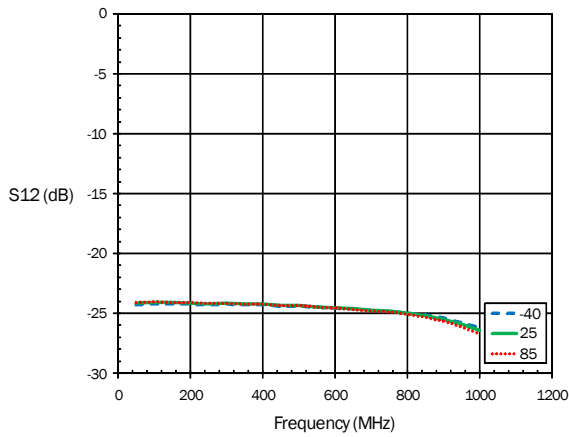

Gain

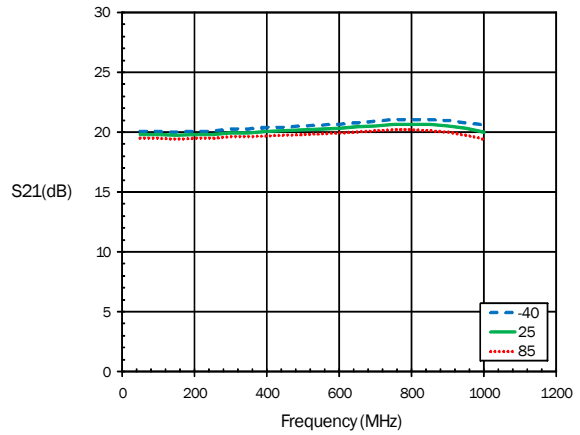

Noise Figure

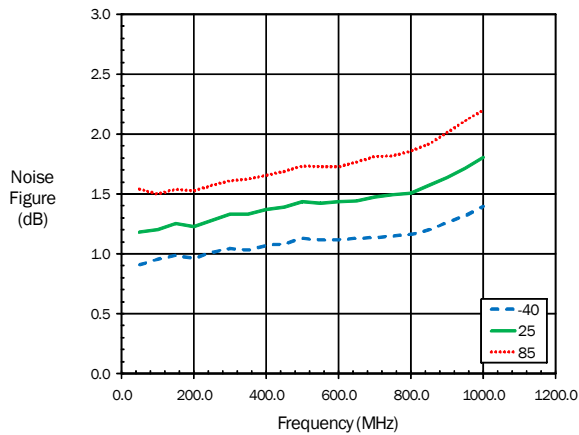

Output P1dB

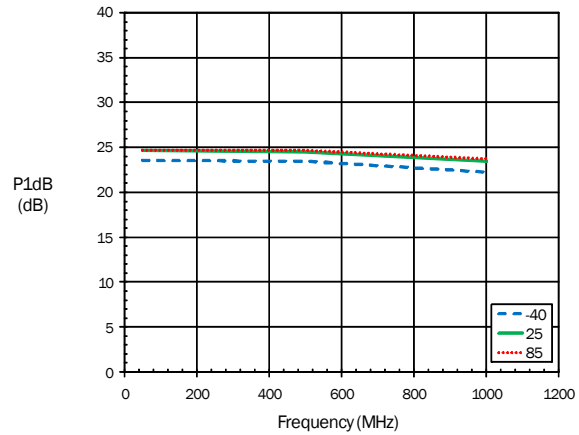

Typical Performance Curves (50Ω)

Output IP2

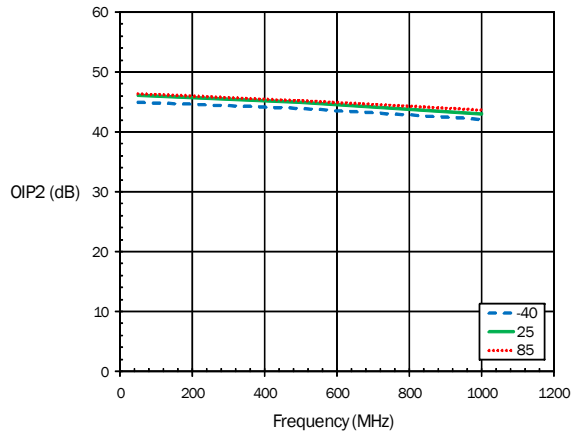

Output IP3

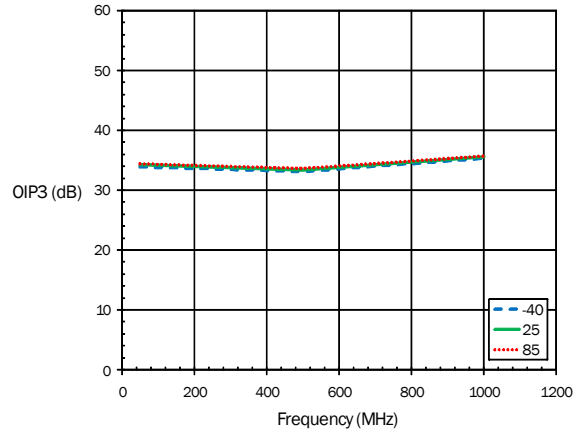

Pin	Function	Description
1	RF IN	RF Input Pin. This pin requires the use of an external DC-blocking capacitor chosen for the frequency of operation.
2, 4	GND	Connection to ground. Use via holes for best performance to reduce lead inductance as close to ground leads as possible.
3	RF OUT/BIAS	RF Output and bias pin. DC-voltage is present on this pin, therefore a DC-blocking capacitor is necessary for proper operation.

Application Schematic - 50Ω and 75Ω 50MHz to 1000MHz Linear Driver

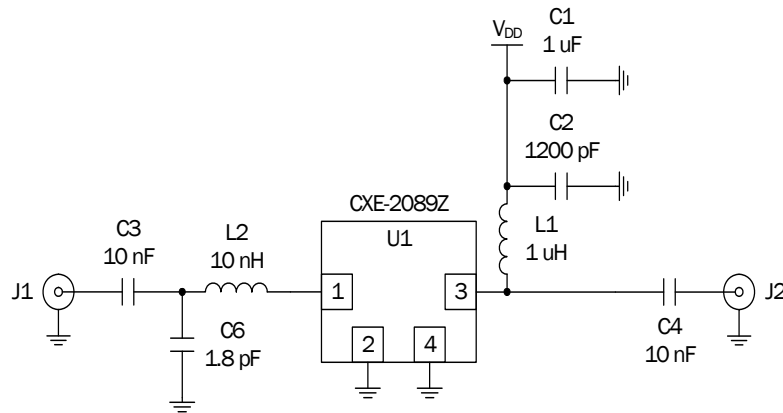

Application Circuit Component Values

Reference Designator	Description
JP1	3 Pin Polarized C onnector - ITW Pancon
J1, J3	Coax F - Trompeter Electronics SMA - Heilind Electronics
L1	1 uH - Coilcraft
L2	10 nH - Toko America
C1	1 uF - Panasonic Industrial
C3, C4	10000 pF - Panasonic Industrial
C2	1200 pF - Panasonic Industrial
C6	1.8 pF - Taiyo Yuden

Evaluation Board Layout - 75Ω

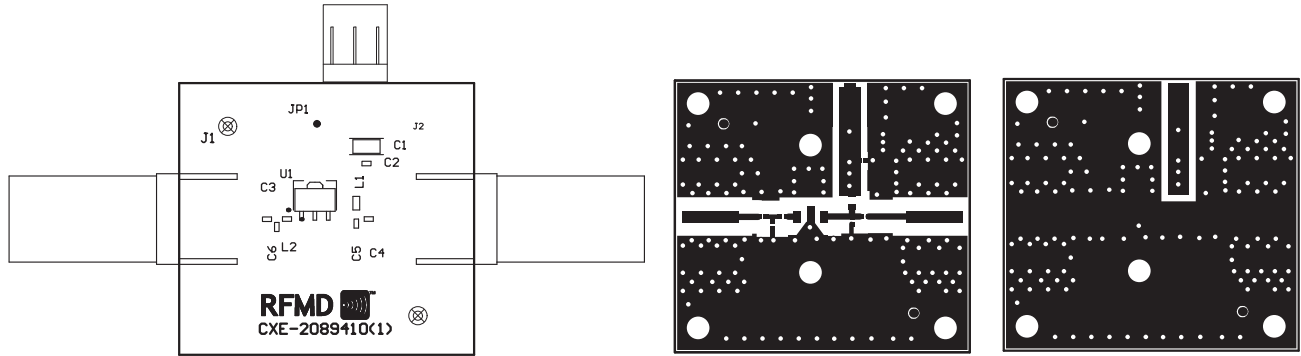

Evaluation Board Layout - 50Ω

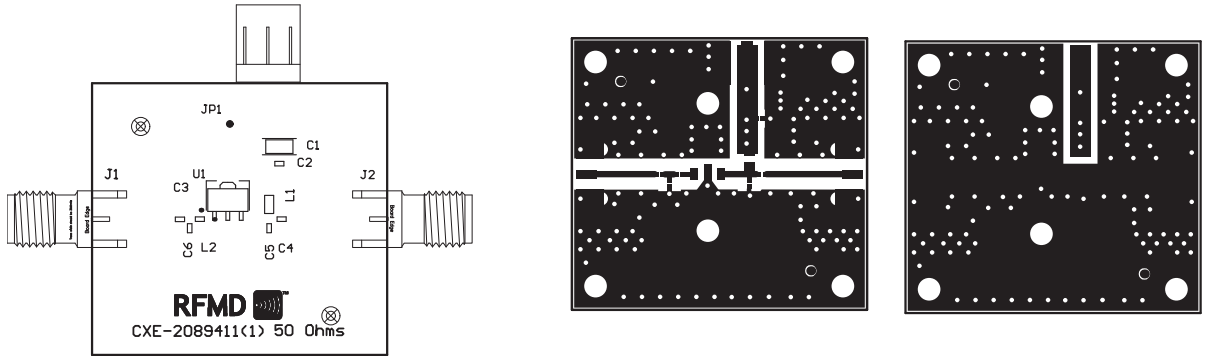

Package Drawing

Package Style: SOT-89

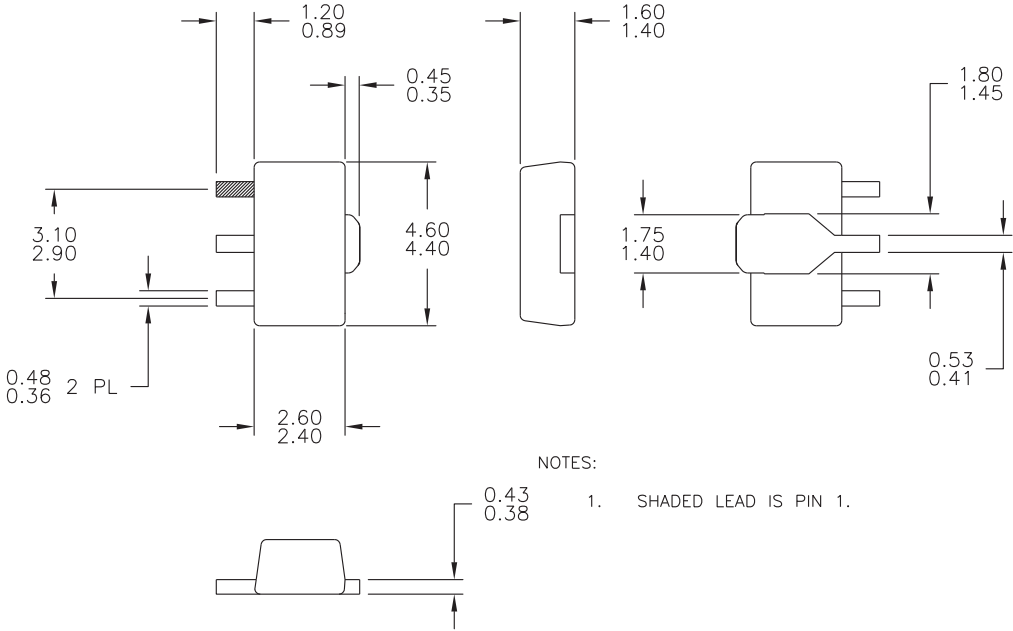

Ordering Information

Part Number	Description	Reel Size (in)	Devices/Reel
CXE-2089ZSB	5 pcs Sample Bag	N/A	N/A
CXE-2089ZSQ	25 pcs Sample Bag	N/A	N/A
CXE-2089ZSR	Amplifier, Lead Free, RoHS Compliant	7	100
CXE-2089ZTR7	Amplifier, Lead Free, RoHS Compliant	7	750
CXE-2089ZPCK-410	75Ω Evaluation Board and 5 pcs Sample Bag	N/A	N/A
CXE-2089ZPCK-411	50Ω Evaluation Board and 5 pcs Sample Bag	N/A	N/A

Mouser Electronics

Authorized Distributor

Click to View Pricing, Inventory, Delivery & Lifecycle Information:

[Qorvo:](#)

[CXE2089ZSR](#) [CXE2089ZTR7](#) [CXE-2089ZPCK-410](#) [CXE-2089ZPCK-411](#)