

TOSHIBA

Leading Innovation >>>

Semiconductor Catalog Sep. 2014

Photocouplers and Photorelays



SEMICONDUCTOR & STORAGE PRODUCTS

<http://toshiba.semicon-storage.com/>

Photocouplers are widely used in various electronic devices to isolate high-speed signals from noise-sensitive circuits. Toshiba's photocouplers consist of a high-intensity infrared light-emitting diode (LED) optically coupled to a photodetector fabricated using the latest process. The LED-photodetector couple is encapsulated in an electrically insulating resin with high transparency. Features of Toshiba's photocouplers include certification to many international safety standards, high isolation and low power consumption. They are suitable for applications requiring a high level of safety.

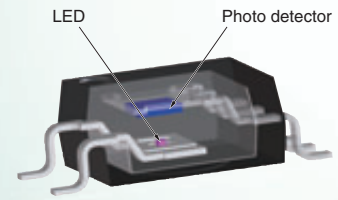

Product Lineup

Both photocouplers and photorelays consist of a light-emitting element and a light-receiving element in the same package. Their input and output signals are optically coupled with each other to provide electrical isolation. Photocouplers and photorelays are available with many output types to meet various interface needs.

Transistor-Output

Page 10

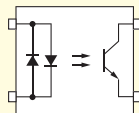

AC input

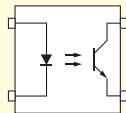

DC input

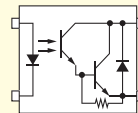

Darlington

IC-Output

Page 16

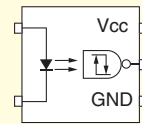

High-Speed Communications

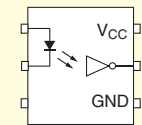

IPM Drive

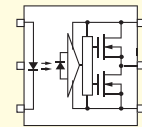

IGBT/MOSFET Drive

Triac Output

Page 44

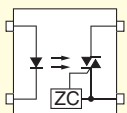

Zero Cross

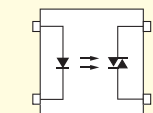

Non Zero Cross

Photocoupler Product Lineup

Thyristor Output

Page 48

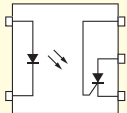

Photovoltaic-Output

Page 49

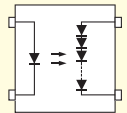

General-Purpose

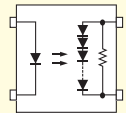

With discharge resistor

Photorelays

page 30

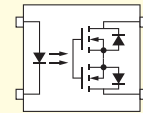

1-Form-A

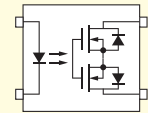

1-Form-B

New Products Digest

Page 6

Board Assembly

Page 66

Part Naming Conventions

Page 50

Device Degradation

Page 68

Package Information

Page 51

Safety Standard Approvals

Page 74

Packing Information

Page 61

Features of Toshiba Photocouplers

Benefits for System Applications

Toshiba's technologies

- High-power infrared LEDs
- 0.13 μm process
- High noise immunity
- High isolation performance
- International safety standard certification

Enhanced safety

Operating temperature (T_{opr}) of up to 125°C, isolation voltage of 5 kVrms, and guaranteed common-mode rejection (CMR) of 40 kV/ μs

Low power consumption

1 mA input current and 3 mW output power consumption

Small and thin packages

SO6 with guaranteed clearance and creepage distances of 5 mm, ultra-small surface-mount USOP

Extensive products

Various output configurations: Transistor-, IC- and triac-output photocouplers, photorelays, etc.

Photocoupler Product Tree

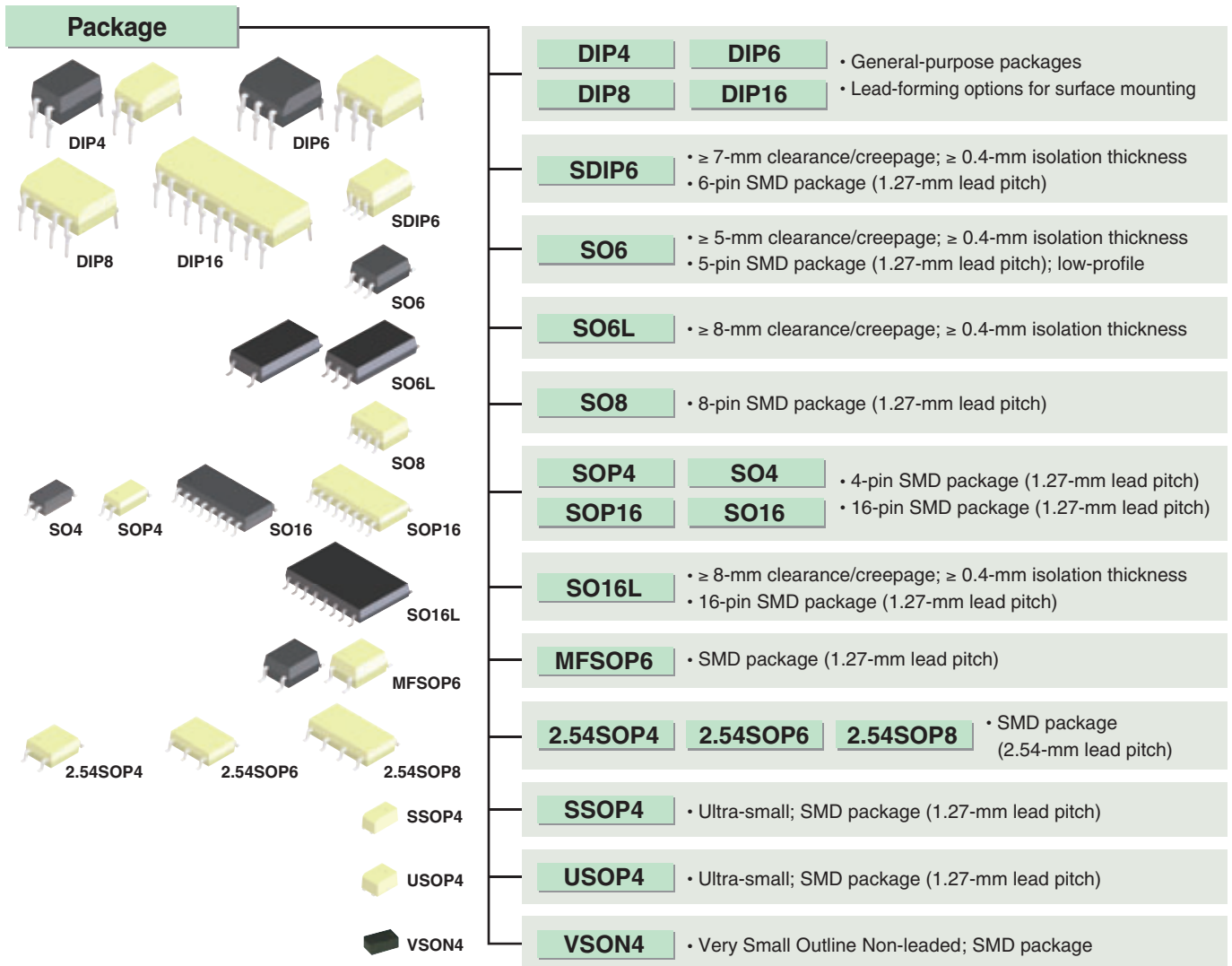

Internal Structure of Toshiba's Photocouplers (Representative example)

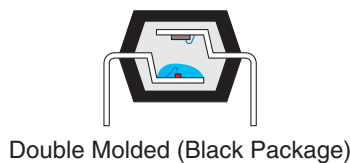
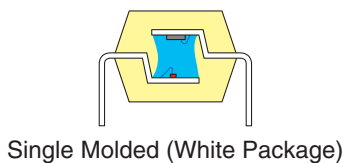

1 Product Index

Part Number	Package	Output	Page
TLP104	SO6	IC	24
TLP109	SO6	IC	17
TLP109(IGM)	SO6	IC	24
TLP116A	SO6	IC	22
TLP117	MFSOP6	IC	24
TLP118	SO6	IC	22
TLP124	MFSOP6	Transistor	12
TLP126	MFSOP6	Transistor	14
TLP127	MFSOP6	Darlington transistor	15
TLP130	MFSOP6	Transistor	14
TLP131	MFSOP6	Transistor	12
TLP137	MFSOP6	Transistor	12
TLP148G	MFSOP6	Thyristor	48
TLP151A	SO6	IC	26
TLP152	SO6	IC	26
TLP155	SO6	IC	26
TLP155E	SO6	IC	26
TLP160G	MFSOP6	Triac	44
TLP160J	MFSOP6	Triac	44
TLP161G	MFSOP6	Triac	44
TLP161J	MFSOP6	Triac	44
TLP163J	MFSOP6	Triac	44
TLP165J	MFSOP6	Triac	44
TLP166J	MFSOP6	Triac	44
TLP168J	MFSOP6	Triac	44
TLP170A	2.54SOP4	MOSFET (Photorelay)	34
TLP170D	2.54SOP4	MOSFET (Photorelay)	34
TLP170G	2.54SOP4	MOSFET (Photorelay)	35
TLP170J	2.54SOP4	MOSFET (Photorelay)	35
TLP171A	2.54SOP4	MOSFET (Photorelay)	34
TLP171D	2.54SOP4	MOSFET (Photorelay)	35
TLP171GA	2.54SOP4	MOSFET (Photorelay)	35
TLP171J	2.54SOP4	MOSFET (Photorelay)	35
TLP172A	2.54SOP4	MOSFET (Photorelay)	34
TLP172G	2.54SOP4	MOSFET (Photorelay)	35
TLP174G	2.54SOP4	MOSFET (Photorelay)	35
TLP174GA	2.54SOP4	MOSFET (Photorelay)	35
TLP175A	SO6	MOSFET (Photorelay)	33
TLP176A	2.54SOP4	MOSFET (Photorelay)	34
TLP176D	2.54SOP4	MOSFET (Photorelay)	35
TLP176G	2.54SOP4	MOSFET (Photorelay)	35
TLP176GA	2.54SOP4	MOSFET (Photorelay)	35
TLP179D	2.54SOP4	MOSFET (Photorelay)	34
TLP182	SO6	Transistor	11
TLP183	SO6	Transistor	11
TLP184 (SE)	SO6	Transistor	11
TLP185 (SE)	SO6	Transistor	11
TLP187	SO6	Darlington transistor	15
TLP188	SO6	Transistor	11
TLP190B	MFSOP6	Photovoltaic	49
TLP191B	MFSOP6	Photovoltaic	49
TLP192A	2.54SOP6	MOSFET (Photorelay)	36
TLP192G	2.54SOP6	MOSFET (Photorelay)	36
TLP197A	2.54SOP6	MOSFET (Photorelay)	36
TLP197D	2.54SOP6	MOSFET (Photorelay)	36
TLP197G	2.54SOP6	MOSFET (Photorelay)	36
TLP197GA	2.54SOP6	MOSFET (Photorelay)	36
TLP199D	2.54SOP6	MOSFET (Photorelay)	36
TLP200D	2.54SOP8	MOSFET (Photorelay)	37
TLP202A	2.54SOP8	MOSFET (Photorelay)	37
TLP202G	2.54SOP8	MOSFET (Photorelay)	37
TLP206E	MFSOP6	IC	22
TLP206A	2.54SOP8	MOSFET (Photorelay)	37
TLP206G	2.54SOP8	MOSFET (Photorelay)	37
TLP206GA	2.54SOP8	MOSFET (Photorelay)	37
TLP2095	MFSOP6	IC	19
TLP2098	MFSOP6	IC	19
TLP209D	2.54SOP8	MOSFET (Photorelay)	37
TLP2105	SO8	IC	19
TLP2108	SO8	IC	19
TLP2116	SO8	IC	22
TLP2118E	SO8	IC	23
TLP2160	SO8	IC	22
TLP2161	SO8	IC	23
TLP2166A	SO8	IC	22
TLP2167	SO8	IC	24
TLP2168	SO8	IC	23
TLP2200	DIP8	IC	20
TLP221A	DIP4	MOSFET (Photorelay)	38
TLP221AF	DIP4	MOSFET (Photorelay)	38
TLP222A	DIP4	MOSFET (Photorelay)	38
TLP222A-2	DIP8	MOSFET (Photorelay)	41
TLP222D	DIP4	MOSFET (Photorelay)	38
TLP222G	DIP4	MOSFET (Photorelay)	39
TLP222G-2	DIP8	MOSFET (Photorelay)	41
TLP224G	DIP4	MOSFET (Photorelay)	39
TLP224G-2	DIP8	MOSFET (Photorelay)	41
TLP224GA	DIP4	MOSFET (Photorelay)	39
TLP224GA-2	DIP8	MOSFET (Photorelay)	41
TLP225A	DIP4	MOSFET (Photorelay)	38
TLP227A	DIP4	MOSFET (Photorelay)	38
TLP227A-2	DIP8	MOSFET (Photorelay)	41
TLP227G	DIP4	MOSFET (Photorelay)	39
TLP227G-2	DIP8	MOSFET (Photorelay)	41
TLP227GA	DIP4	MOSFET (Photorelay)	39
TLP227GA-2	DIP8	MOSFET (Photorelay)	41
TLP228G	DIP4	MOSFET (Photorelay)	38
TLP228G-2	DIP8	MOSFET (Photorelay)	41
TLP2301	SO6	IC	16
TLP2303	SO6	IC	17
TLP2309	SO6	IC	17
TLP2310	SO6	IC	19
TLP2345	SO6	IC	21

Part Number	Package	Output	Page
TLP2348	SO6	IC	21
TLP2355	SO6	IC	19
TLP2358	SO6	IC	19
TLP2361	SO6	IC	22
TLP2362	SO6	IC	21
TLP2366	SO6	IC	22
TLP2367	SO6	IC	24
TLP2368	SO6	IC	22
TLP2391	SO6	IC	21
TLP2395	SO6	IC	19
TLP2398	SO6	IC	19
TLP2403	SO8	IC	17
TLP2404	SO8	IC	24
TLP2405	SO8	IC	19
TLP2408	SO8	IC	19
TLP2409	SO8	IC	17
TLP240A	DIP4	MOSFET (Photorelay)	38
TLP240AF	DIP4	MOSFET (Photorelay)	38
TLP240D	DIP4	MOSFET (Photorelay)	38
TLP240DF	DIP4	MOSFET (Photorelay)	38
TLP240G	DIP4	MOSFET (Photorelay)	38
TLP240GA	DIP4	MOSFET (Photorelay)	39
TLP240GAF	DIP4	MOSFET (Photorelay)	39
TLP240GF	DIP4	MOSFET (Photorelay)	38
TLP240J	DIP4	MOSFET (Photorelay)	39
TLP240JF	DIP4	MOSFET (Photorelay)	39
TLP2418	SO8	IC	22
TLP241A	DIP4	MOSFET (Photorelay)	38
TLP241AF	DIP4	MOSFET (Photorelay)	38
TLP2451A	SO8	IC	26
TLP2466	SO8	IC	22
TLP2468	SO8	IC	22
TLP250H	DIP8	IC	28
TLP250HF	DIP8	IC	28
TLP2530	DIP8	IC	18
TLP2531	DIP8	IC	18
TLP2601	DIP8	IC	21
TLP2630	DIP8	IC	21
TLP2631	DIP8	IC	21
TLP265J	SO6	Triac	44
TLP2662	DIP8	IC	21
TLP2662F	DIP8	IC	21
TLP266J	SO6	Triac	45
TLP267J	SO6	Triac	45
TLP268J	SO6	Triac	45
TLP2703	SO6L	IC	17
TLP2766	SDIP6	IC	23
TLP2766F	SDIP6	IC	23
TLP2767	SDIP6	IC	24
TLP2767F	SDIP6	IC	24
TLP2768	SDIP6	IC	23
TLP2768F	SDIP6	IC	23
TLP280-4	SOP16	Transistor	14
TLP281-4	SOP16	Transistor	12
TLP290 (SE)	SO4	Transistor	11
TLP290-4	SO16	Transistor	14
TLP291 (SE)	SO4	Transistor	11
TLP291-4	SO16	Transistor	12
TLP292	SO4	Transistor	11
TLP292-4	SO16	Transistor	14
TLP293	SO4	Transistor	11
TLP293-4	SO16	Transistor	12
TLP2955	DIP8	IC	20
TLP2955F	DIP8	IC	20
TLP2958	DIP8	IC	20
TLP2958F	DIP8	IC	20
TLP2962	DIP8	IC	21
TLP2962F	DIP8	IC	21
TLP3022(S)	DIP6	Triac	46
TLP3022F(S)	DIP6	Triac	46
TLP3023(S)	DIP6	Triac	46
TLP3023F(S)	DIP6	Triac	46
TLP3042(S)	DIP6	Triac	46
TLP3042F(S)	DIP6	Triac	46
TLP3043(S)	DIP6	Triac	46
TLP3043F(S)	DIP6	Triac	46
TLP3052(S)	DIP6	Triac	47
TLP3052F(S)	DIP6	Triac	47
TLP3062(S)	DIP6	Triac	47
TLP3062F(S)	DIP6	Triac	47
TLP3063(S)	DIP6	Triac	47
TLP3063F(S)	DIP6	Triac	47
TLP3064(S)	DIP6	Triac	47
TLP3064F(S)	DIP6	Triac	47
TLP3082(S)	DIP6	Triac	47
TLP3082F(S)	DIP6	Triac	47
TLP3100	2.54SOP6	MOSFET (Photorelay)	36
TLP3102	2.54SOP6	MOSFET (Photorelay)	36
TLP3103	2.54SOP6	MOSFET (Photorelay)	36
TLP3105	2.54SOP6	MOSFET (Photorelay)	36
TLP3107	2.54SOP6	MOSFET (Photorelay)	36
TLP3111	2.54SOP4	MOSFET (Photorelay)	34
TLP3114	2.54SOP4	MOSFET (Photorelay)	34
TLP3115	2.54SOP4	MOSFET (Photorelay)	34
TLP3116	2.54SOP4	MOSFET (Photorelay)	34
TLP3118	2.54SOP4	MOSFET (Photorelay)	34
TLP3119	2.54SOP4	MOSFET (Photorelay)	34
TLP3120	2.54SOP6	MOSFET (Photorelay)	36
TLP3121	2.54SOP4	MOSFET (Photorelay)	34
TLP3122	2.54SOP4	MOSFET (Photorelay)	34
TLP3123	2.54SOP4	MOSFET (Photorelay)	34
TLP3125	2.54SOP8	MOSFET (Photorelay)	37
TLP3130	2.54SOP4	MOSFET (Photorelay)	34

Part Number	Package	Output	Page
TLP3131	2.54SOP4	MOSFET (Photorelay)	34
TLP3203	SSOP4	MOSFET (Photorelay)	33
TLP3212	SSOP4	MOSFET (Photorelay)	33
TLP3214	SSOP4	MOSFET (Photorelay)	33
TLP3215	SSOP4	MOSFET (Photorelay)	33
TLP3216	SSOP4	MOSFET (Photorelay)	33
TLP3217	SSOP4	MOSFET (Photorelay)	33
TLP3220	SSOP4	MOSFET (Photorelay)	33
TLP3230	SSOP4	MOSFET (Photorelay)	33
TLP3231	SSOP4	MOSFET (Photorelay)	33
TLP3240	SSOP4	MOSFET (Photorelay)	33
TLP3241	SSOP4	MOSFET (Photorelay)	33
TLP3250	SSOP4	MOSFET (Photorelay)	33
TLP3275	SSOP4	MOSFET (Photorelay)	33
TLP3303	USOP4	MOSFET (Photorelay)	32
TLP3306	USOP4	MOSFET (Photorelay)	32
TLP331	DIP6	Transistor	12
TLP3312	USOP4	MOSFET (Photorelay)	32
TLP3315	USOP4	MOSFET (Photorelay)	32
TLP3316	USOP4	MOSFET (Photorelay)	32
TLP3317	USOP4	MOSFET (Photorelay)	32
TLP3319	USOP4	MOSFET (Photorelay)	32
TLP332	DIP6	Transistor	12
TLP3320	USOP4	MOSFET (Photorelay)	32
TLP3330	USOP4	MOSFET (Photorelay)	32
TLP3331	USOP4	MOSFET (Photorelay)	32
TLP3340	USOP4	MOSFET (Photorelay)	32
TLP3341	USOP4	MOSFET (Photorelay)	32
TLP3342	USOP4	MOSFET (Photorelay)	32
TLP3350	USOP4	MOSFET (Photorelay)	32
TLP3351	USOP4	MOSFET (Photorelay)	32
TLP3375	USOP4	MOSFET (Photorelay)	32
TLP3403	VSON4	MOSFET (Photorelay)	31
TLP3412	VSON4	MOSFET (Photorelay)	31
TLP3417	VSON4	MOSFET (Photorelay)	31
TLP3420	VSON4	MOSFET (Photorelay)	31
TLP3440	VSON4	MOSFET (Photorelay)	31
TLP3475	VSON4	MOSFET (Photorelay)	31
TLP350	DIP8	IC	28
TLP350F	DIP8	IC	28
TLP350H	DIP8	IC	29
TLP350HF	DIP8	IC	29
TLP351	DIP8	IC	28
TLP351A	DIP8	IC	28
TLP351AF	DIP8	IC	28
TLP351F	DIP8	IC	28
TLP351H	DIP8	IC	28
TLP351HF	DIP8	IC	28
TLP352	DIP8	IC	29
TLP352F	DIP8	IC	29
TLP3542	DIP6	MOSFET (Photorelay)	40
TLP3543	DIP6	MOSFET (Photorelay)	40
TLP3544	DIP6	MOSFET (Photorelay)	40
TLP3545	DIP6	MOSFET (Photorelay)	40
TLP3546	DIP6	MOSFET (Photorelay)	40
TLP3553	DIP4	MOSFET (Photorelay)	38
TLP3554	DIP4	MOSFET (Photorelay)	38
TLP3555	DIP4	MOSFET (Photorelay)	38
TLP3556	DIP4	MOSFET (Photorelay)	38
TLP358	DIP8	IC	29
TLP358F	DIP8	IC	29
TLP358H	DIP8	IC	29
TLP358HF	DIP8	IC	29
TLP360J	DIP4	Triac	45
TLP360JF	DIP4	Triac	45
TLP361J	DIP4	Triac	45
TLP361JF	DIP4	Triac	45
TLP363J	DIP4	Triac	45
TLP363JF	DIP4	Triac	45
TLP371	DIP6	Darlington transistor	15
TLP372	DIP6	Darlington transistor	15
TLP373	DIP6	Darlington transistor	15
TLP3762(S)	DIP6	Triac	47
TLP3762F(S)	DIP6	Triac	47
TLP3782(S)	DIP6	Triac	47
TLP3782F(S)	DIP6	Triac	47
TLP3783(S)	DIP6	Triac	47
TLP3783F(S)	DIP6	Triac	47
TLP385	SO6L	Transistor	12
TLP3902	MFSOP6	Photovoltaic	49
TLP3904	SSOP4	Photovoltaic	49
TLP3905	SO6	Photovoltaic	49
TLP3906	SO6	Photovoltaic	49
TLP3914	SSOP4	Photovoltaic	49
TLP3924	SSOP4	Photovoltaic	49
TLP4006G	DIP8	MOSFET (Photorelay)	43
TLP4026G	2.54SOP8	MOSFET (Photorelay)	43
TLP4176G	2.54SOP4	MOSFET (Photorelay)	42
TLP4197G	2.54SOP6	MOSFET (Photorelay)	42
TLP4206G	2.54SOP8	MOSFET (Photorelay)	43
TLP4227G	DIP4	MOSFET (Photorelay)	42
TLP4227G-2	DIP8	MOSFET (Photorelay)	43
TLP4597G	DIP6	MOSFET (Photorelay)	42
TLP512	DIP6	IC	17
TLP513	DIP6	IC	21
TLP5214	SO16L	IC	27
TLP523	DIP4	Darlington transistor	15
TLP525G	DIP4	Triac	46
TLP531	DIP6	Transistor	12
TLP532	DIP6	Transistor	12
TLP548J	DIP6	Thyristor	48
TLP549J	DIP8	Thyristor	48

Part Number	Package	Output	Page
TLP550	DIP8	IC	17
TLP551	DIP8	IC	18
TLP552	DIP8	IC	21
TLP553	DIP8	IC	17
TLP554	DIP8	IC	21
TLP555	DIP8	IC	20
TLP557	DIP8	IC	28
TLP558	DIP8	IC	20
TLP559	DIP8	IC	18
TLP559(IGM)	DIP8	IC	24
TLP560G	DIP6	Triac	46
TLP560J	DIP6	Triac	47
TLP561G	DIP6	Triac	46
TLP561J	DIP6	Triac	47
TLP570	DIP6	Darlington transistor	15
TLP5701	SO6L	IC	26
TLP5702	SO6L	IC	27
TLP571	DIP6	Darlington transistor	15
TLP572	DIP6	Darlington transistor	15
TLP5751	SO6L	IC	27
TLP5752	SO6L	IC	27
TLP5754	SO6L	IC	27
TLP590B	DIP6	Photovoltaic	49
TLP591B	DIP6	Photovoltaic	49
TLP592A	DIP6	MOSFET (Photorelay)	40
TLP592G	DIP6	MOSFET (Photorelay)	40
TLP597A	DIP6	MOSFET (Photorelay)	40
TLP597G	DIP6	MOSFET (Photorelay)	40
TLP597GA	DIP6	MOSFET (Photorelay)	40
TLP598AA	DIP6	MOSFET (Photorelay)	40
TLP598GA	DIP6	MOSFET (Photorelay)	40
TLP620	DIP4	Transistor	14
TLP620F	DIP4	Transistor	14
TLP624	DIP4	Transistor	12
TLP626	DIP4	Transistor	14
TLP627	DIP4	Darlington transistor	15
TLP628	DIP4	Transistor	13
TLP630	DIP6	Transistor	14
TLP631	DIP6	Transistor	13
TLP632	DIP6	Transistor	13
TLP651	DIP8	IC	18
TLP700	SDIP6	IC	28
TLP700A	SDIP6	IC	28
TLP700AF	SDIP6	IC	28
TLP700F	SDIP6	IC	28
TLP700H	SDIP6	IC	28
TLP700HF	SDIP6	IC	28
TLP701	SDIP6	IC	27
TLP701A	SDIP6	IC	27
TLP701AF	SDIP6	IC	27
TLP701F	SDIP6	IC	27
TLP701H	SDIP6	IC	27
TLP701HF	SDIP6	IC	27
TLP705A	SDIP6	IC	27
TLP705AF	SDIP6	IC	27
TLP708	SDIP6	IC	23
TLP708F	SDIP6	IC	23
TLP714	SDIP6	IC	24
TLP714F	SDIP6	IC	24
TLP715	SDIP6	IC	19
TLP715F	SDIP6	IC	19
TLP716	SDIP6	IC	23
TLP716F	SDIP6	IC	23
TLP718	SDIP6	IC	20
TLP718F	SDIP6	IC	20
TLP719	SDIP6	IC	17
TLP719F	SDIP6	IC	17
TLP731	DIP6	Transistor	13
TLP732	DIP6	Transistor	13
TLP733	DIP6	Transistor	13
TLP733F	DIP6	Transistor	13
TLP734	DIP6	Transistor	13
TLP734F	DIP6	Transistor	13
TLP748J	DIP6	Thyristor	48
TLP748JF	DIP6	Thyristor	48
TLP750	DIP8	IC	18
TLP750F	DIP8	IC	18
TLP751	DIP8	IC	18
TLP751F	DIP8	IC	18
TLP754	DIP8	IC	25
TLP754F	DIP8	IC	25
TLP759	DIP8	IC	18
TLP759(IGM)	DIP8	IC	25
TLP759F	DIP8	IC	18
TLP759F(IGM)	DIP8	IC	25
TLP762J	DIP6	Triac	47
TLP762JF	DIP6	Triac	47
TLP763J	DIP6	Triac	47
TLP763JF	DIP6	Triac	47
TLP785	DIP4	Transistor	13
TLP785F	DIP4	Transistor	13
TLP797GA	DIP6	MOSFET (Photorelay)	40
TLP797GAF	DIP6	MOSFET (Photorelay)	40
TLP797J	DIP6	MOSFET (Photorelay)	40
TLP797JF	DIP6	MOSFET (Photorelay)	40
TLP798GA	DIP6	MOSFET (Photorelay)	40
TLPN137	DIP8	IC	21
6N135	DIP8	IC	25
6N136	DIP8	IC	25
6N137	DIP8	IC	25
6N138	DIP8	IC	25
6N139	DIP8	IC	25

2 New Products Digest

Low-PWD, IC-Output Photocouplers for IPM Drives: TLP2345, TLP2348

The TLP2345 and TLP2348 photocouplers are specifically designed to drive intelligent power modules (IPMs). These photocouplers feature high speed, high-temperature operation and low power consumption. They offer a wide supply voltage range ($V_{CC} = 4.5$ to 30 V) in a compact package. As such, they are suited not only to IPM drives, but also to a wide range of industrial and other applications, including communication interfaces (RS232, RS433, and RS485, etc.), and solutions for data transmission between circuits with different voltages.

■ Features

- Wide operating temperature range: $T_{opr} = -40$ to 110°C
- Allows direct driving by a microcontroller
 - Supply current: 3 mA (max)
 - Threshold input current: 1.6 mA (max)
- High noise immunity between the input and the output Common-mode transient immunity: $|CM_H|, |CM_L| \geq 30$ kV/ μs

■ Key Specifications

Characteristics	TLP2345	TLP2348
	Buffer logic	Inverter logic
Supply voltage V_{CC}	4.5 to 30 V	
Propagation delay time t_{pHL}/t_{pLH} (max)	120 ns	
Pulse width distortion $ t_{pHL}-t_{pLH} $ (max)	40 ns	
Propagation delay skew t_{psk}	70 ns	
Isolation voltage BVs (min)	3750 Vrms	

High-Speed IC-Output Photocoupler That Supports Both Positive and Negative Input Excursions: TLP2391

The TLP2391 photocoupler allows high-speed communications, making it suitable for servo motor and programmable logic controller (PLC) applications. It supports both positive and negative excursions of the input. While PLCs in Japan primarily use sink logic to provide an input to the photocoupler, those outside of Japan mainly use source logic for this purpose. The TLP2391 has two anti-parallel LEDs to allow both sink and source logic inputs, eliminating the need for an external bridge circuit.

The TLP2391 supports a data rate of up to 10 Mbps, making it suitable for high-speed communication interface applications (RS232, RS422, RS485, etc.) in industrial equipment.

■ Features

- Operating temperature: $T_{opr} = -40$ to 125°C
- Supply voltage: $V_{CC} = 2.7$ to 5.5 V
- Supply current: $I_{CC} = 1$ mA
- Threshold input current: $I_{FHL} = 2.3$ mA ($V_{CC} = 3.3$ V)
 $I_{FHL} = 2.5$ mA ($V_{CC} = 5.0$ V)
- Propagation delay time: $t_{pHL}/t_{pLH} = 100$ ns (max)
- Pulse width distortion: $|t_{pHL}-t_{pLH}| = 30$ ns (max)
- Propagation delay skew: $t_{psk} = 40$ ns (max)

■ Applications

- Programmable logic controllers (PLC)
- Servo motors
- General-purpose inverters
- Industrial automation equipment

IC Output

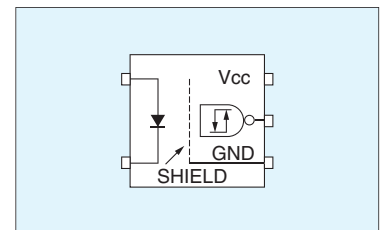
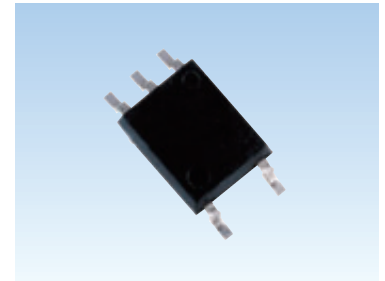

■ Package: 5-pin SO6

■ Applications

- FA (for IPM drive)
- High-speed digital interface for measurement or control devices
- Programmable logic controllers

IC Output

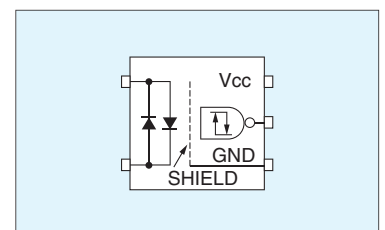
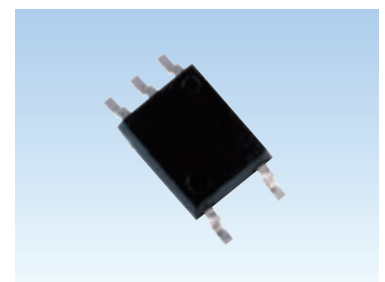

■ Package: 5-pin SO6

High-Current Photorelays with Reinforced Insulation: TLP241A, TLP241AF

The TLP241A/AF is the new addition to the TLP240 series of low-cost photorelays with reinforced insulation. With a guaranteed maximum on-state current of 2 A, it is particularly well suited for use in factory automation (FA), which requires the control of high current.

Housed in the double-mold DIP4 package, it offers an isolation voltage of 5000 Vrms (AC, 1 minute) for reinforced insulation.

With the release of the TLP241A/AF, the TLP240 series now offers an even wider off-state output terminal voltage range of 40 to 600 V. It is suitable for a wide range of applications such as FA, smart meters and security equipment.

■ Features

- ON-state current: $I_{ON} = 2 \text{ A}$ (max)
- OFF-state output terminal voltage: $V_{OFF} = 40 \text{ V}$ (min)
- Isolation voltage: $BV_S = 5000 \text{ Vrms}$ (min)
- Two devices with different clearance and creepage distances
 - TLP241A: 7 mm (min)
 - TLP241AF: 8 mm (min)

■ Applications

- Replace mechanical relays
- Security systems
- Measurement control systems, factory automation (FA) control systems
- Watt-hour meters, gas meters and water meters
- Smart meters
- Medical equipment

Photorelay

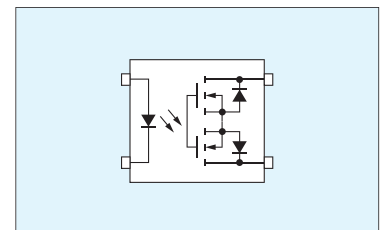
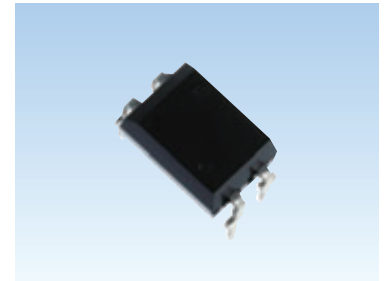

■ Package: DIP4

15-Mbps Low-Power-Consumption IC-Output Photocoupler TLP2361, TLP2161

The TLP2361 and TLP2161 photocouplers feature low power consumption and a transfer rate of 15 Mbps. Thanks to the use of Toshiba's proprietary high-reliability, high-output infrared LED, low threshold input current has been realized. This means these photocouplers can be driven directly by a microprocessor without requiring a buffer, which contributes to lower power consumption of the system in where they are used.

Because the new LED is stable even at high ambient temperatures, operation is guaranteed up to a temperature rating of 125°C. The BiCMOS process makes it possible to keep the supply current to 1 mA or less per channel. In order to accommodate the trend towards lower power voltages, the receiver IC characteristics are guaranteed over a power voltage range from 2.7 to 5.5 V.

■ Features

- Low-voltage operation
 - Guaranteed supply voltage range: $V_{CC} = 2.7$ to 5.5 V
- Data transfer rate: 15 Mbps (typ.) (NRZ)
- Low supply current thanks to the BiCMOS process
 - Supply current: TLP2361 = 1.0 mA (max)
 - TLP2161 = 2.0 mA (max)
- Low threshold input current
 - 1.3 mA (max) (at $T_a = 105^\circ\text{C}$)
 - 1.6 mA (max) (at $T_a = 125^\circ\text{C}$)
- High noise immunity between the input and the output
 - Common-mode transient immunity: $|CM_H|, |CM_L| \geq 20 \text{ kV}/\mu\text{s}$
- Guaranteed operation at high temperatures
 - Operating temperature range: $T_{opr} = -40$ to 125°C

■ Applications

- FA networks
- I/O interface boards
- High-speed digital interfaces in PLCs, controllers, etc.

IC Output

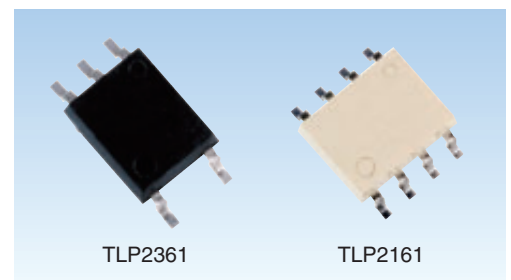

TLP2361

TLP2161

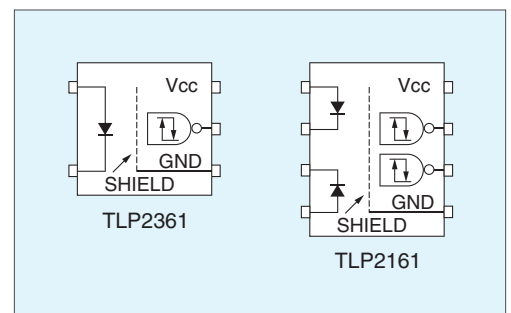

■ Package: 5-pin SO6 (TLP2361)
SO8 (TLP2161)

2 New Products Digest

Low-Input-Current Transistor-Output Photocouplers: TLP182, TLP183, TLP292, TLP293

The TLP182 and TLP183 are low-input-current-type transistor-output photocoupler utilizing the SO6 package.

By employing Toshiba's original high-output LED, these products guarantee not only a high current transfer ratio at the conventional input current of 5 mA, but also the same current transfer ratio at the low LED current of 0.5 mA.

Especially when utilizing LED current at 100 VAC and other high voltages, these products significantly contribute to a reduction in power consumption by reducing the LED current of the photocoupler. The TLP182 and TLP183 also support operation at up to an ambient temperature of 125°C, allowing for reliable use in industrial devices, compact power supplies and other devices used in environments of severe heat.

We have also released the TLP292 and TLP293, which utilize the smaller SO4 package.

■ Features

- Smaller and thinner package produced in high efficiency production lines (SO6 and SO4)
- Guaranteed high current transfer ratio (CTR) at low input current of 0.5 mA
- Guaranteed proper operation at ambient temperatures up to 125°C
- Produced overseas (Thailand)

■ Applications

- Switching power supplies
- Industrial devices (PLCs, inverters)
- AC line detection for household appliances

Transistor Output

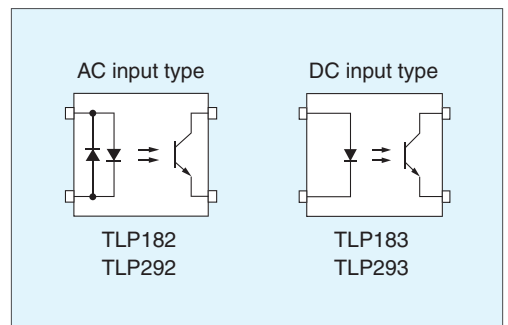
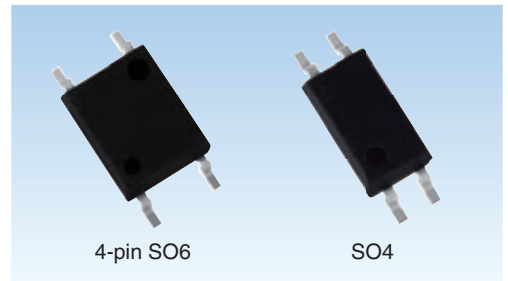

■ **Package:** 4-pin SO6 (TLP182/TLP183)
SO4 (TLP292/TLP293)

Triac-Output Photocouplers with Reinforced Insulation Supporting Low Input Current Control TLP267J, TLP268J

Toshiba has released 600-V triac-output photocouplers and added to its lineup: TLP267J, a NZC (Non Zero Cross) type, and TLP268J, a ZC (Zero Cross) type. They support LED trigger current (max) of 3 mA for standard products or even 2 mA for selected products, allowing output-side control by low input current. This contributes to energy saving in the apparatus that use these products. In addition, by using the double-mold SO6 package, they feature reinforced insulation with 3750 Vrms (AC, 1 minute) isolation voltage between the input and the output.

In addition to guaranteed creepage distance/clearance of 5 mm (min), these products will be certified for UL/cUL/VDE standards. In addition, the use of long-lifetime LEDs enhances design flexibility. These products also support JEDEC-standard reflow mounting, allowing more convenient handling.

■ Features

- Reinforced insulation: Isolation voltage, BVs = 3750 Vrms (AC, 1 minute)
- Support of mounting in accordance with the JEDEC standard
- Support of LED trigger current (IFT) rank
No rank: 3 mA (max)
(IFT2): 2 mA (max)
- UL, cUL and VDE approvals

■ Applications

- Triac drivers
- Programmable controllers
- AC output modules
- Solid-state relays

Triac Output

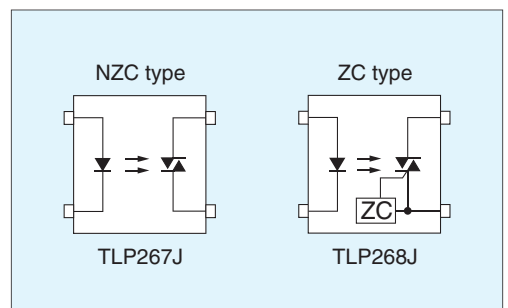
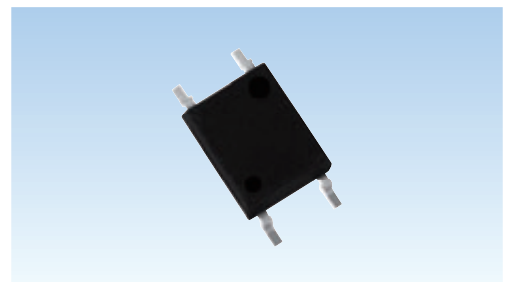

■ **Package:** 4-pin SO6

Photorelays in Industry's Smallest Package: TLP3403, TLP3412

Toshiba has released the TLP3403 and TLP3412 photorelays in the industry's smallest^[1] VSON (Very Small Outline Non-leaded) package in production quantities. Compared to equivalent Toshiba products in a USOP package, the new photorelays reduce the assembly area by 50% and volume by 60%. This can contribute to the development of smaller and thinner systems and also makes it possible to increase the number of photorelays on a circuit board to 1.3 times to 1.5 times that of conventional products.

Also, by using a new internal structure, a chip-on-chip structure^[2], the new products, while retaining the same electrical characteristics as conventional USOP package products, secure improved high-frequency characteristics, which are necessary for signal transmission. The new photocouplers are suitable for various tester applications, especially for use in power-line switching and measuring-line switching.

Key Specifications

Part Number	TLP3403	TLP3412
Package Dimension	VSON package Area: 1.5 mm x 2.5 mm (max), Height: 1.3 mm (max)	
On-state Current I _{ON}	1 A (max)	0.4 A (max)
On-state Resistance R _{ON}	0.18 Ω (typ.) / 0.22 Ω (max)	1 Ω (typ.) / 1.5 Ω (max)
Off-state Voltage V _{OFF}	20 V (min)	60 V (min)
Off-state Capacitance (Photo side) C _{OFF}	40 pF (typ.)	20 pF (typ.)
Trigger LED Current I _{FT}	3 mA (max)	
Equivalent Rise Time (Pass Characteristic)	40 ps (typ.)	
Isolation Voltage BV _s	300 V _{rms} (min)	

Note1: For photocoupler products, as of January 31, 2014. Toshiba survey.

Note2: Chip-on-chip structure: A structure that mounts an LED chip on top of a detector chip, with insulation material in between.

Photorelay

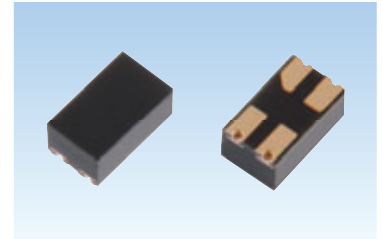

Package: VSON

Gate-Drive Photocouplers in the Thin SO6L Package TLP5701, TLP5702

Toshiba has released low-height SO6L package gate-drive photocouplers for use in driving small- to medium-power IGBTs and power MOSFETs. The TLP5701 for driving small-power IGBTs/MOSFETs and the TLP5702 for driving middle-power IGBTs/MOSFETs are the first Toshiba photocouplers to use the low-height SO6L package. At only 54% of Toshiba products that use the SDIP6 package, the new devices will contribute to development of thinner systems. In spite of their low height, the devices guarantee a creepage distance of 8 mm, making them suitable for applications requiring higher isolation specs.

The TLP5701 and TLP5702 achieve low supply current of 2.0 mA (max) and low power consumption by utilizing BiCMOS process technology. Combined with an original high-power, high-reliability infrared LED, they can be used in a wide range of applications, including those that require high thermo-stability, such as factory automation and home photovoltaic power systems, digital home appliances and control equipment. Maximum propagation delay time and propagation delay skew are guaranteed within the defined operation temperature range (up to 110 degrees Centigrade), making it possible to reduce dead time in the inverter circuit, which can secure higher operating efficiency.

Key Specifications

Part Number	TLP5701	TLP5702
Peak Output Current I _{OP}	±0.6 A (max)	±2.5 A (max)
Peak Output Current V _{CC}	10 V to 30 V	15 V to 30 V
Supply Current I _{CC}	2.0 mA (max)	3.0 mA (max)
Threshold Input Current I _{FLH}	5 mA (max)	
Propagation Delay Time t _{pLH} /t _{pHL}	500 ns (max)	200 ns (max)
Propagation Delay Skew t _{psk}	-80 to 80 ns	
Creepage Distance	8 mm (min)	
Isolation Voltage BV _s	5000 V _{rms} (min)	
Operation Temperature Range T _{opr}	-40°C to 110°C	
Applications	For driving small-size power IGBTs (up to 20 A class) and power MOSFETs. • FA Inverter • Power Supply (UPS) • AC Servo • Air Conditioner Inverters • Home Appliances	For driving middle-size power IGBTs (up to 80 A class) and power MOSFETs. • FA Inverter • Photovoltaic Inverter • Power Supply (UPS) • AC Servo • Induction Cooking

IC Output for IGBT/MOSFET Drive

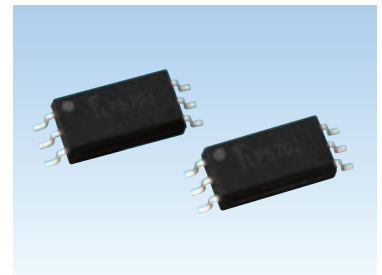

Package: SO6L

3 Selection Guide

1 Transistor-Output and Darlington-Transistor-Output Photocouplers

Features		Package								
										
		SO4	SOP16	SO16	SO6	SO6L	MFSOP6	DIP6	DIP4	
Isolation Voltage		Single	Quad	Quad	Single	Single	Single	Single	Single	
General-purpose	2500 Vrms		TLP281-4	TLP291-4				TLP531 TLP532		
	3750 Vrms	TLP291(SE)*			TLP185(SE)*		TLP131			
	4000 Vrms							TLP731 TLP732 TLP733 TLP734		
	5000 Vrms					TLP385*		TLP631 TLP632	TLP785	
Low I _F	3750 Vrms	TLP293*		TLP293-4*	TLP183*		TLP124 TLP137			
	5000 Vrms							TLP331 TLP332	TLP624	
High V _{CEO}	3750 Vrms				TLP188*					
	5000 Vrms								TLP628	
AC input	2500 Vrms		TLP280-4	TLP290-4						
	3750 Vrms	TLP290(SE)*			TLP184(SE)*		TLP130			
	5000 Vrms							TLP630	TLP620	
Low I _F	3750 Vrms	TLP292*		TLP292-4*	TLP182*		TLP126			
	5000 Vrms								TLP626	
Darlington	2500 Vrms							TLP570 TLP571 TLP572	TLP523	
High V _{CEO}	2500 Vrms						TLP127			
	3750 Vrms				TLP187					
	5000 Vrms							TLP371 TLP372 TLP373	TLP627	

*: New product

**Reinforced Insulation in a Small, Surface-Mount SOP Package
($\geq 5\text{-mm}$ Clearance/Creepage and $\geq 0.4\text{-mm}$ Internal Isolation Thickness)**

Part Number	Pin Configuration	Features	CTR				V_{CE0} (V)	BVs 1 Minute (Vrms)	Safety Standards (1)					
			Rank	Min (%)	Max (%)	@ I_F / V_{CE} (mA) (V)			UL	c-UL	TÜV	VDE	BSI	CQC
TLP182 *		SO6 (reinforced insulation) AC input Low input drive current	—	50	600	$\pm 0.5/5$	80	3750	○	○	□		○	
			Y	50	150									
			GR	100	300									
			BL	200	600									
			GB	100	600									
TLP183 *		SO6 (reinforced insulation) Low input drive current	—	50	600	0.5/5	80	3750	○	○	□		○	
			GB	100	600									
			Y	50	150									
			GR	100	300									
			BL	200	600									
			YH	75	150									
			GRL	100	200									
			GRH	150	300									
BLL	200	400												
TLP184 (SE) *		SO6 (reinforced insulation) AC input	—	50	600	$\pm 5/5$	80	3750	○	○	△	□	○	△
			Y	50	150									
			GR	100	300									
			BL	200	600									
			GB	100	600									
TLP185 (SE) *		SO6 (reinforced insulation) General-purpose	—	50	600	5/5	80	3750	○	○	△	□	○	△
			GB	100	600									
			Y	50	150									
			GR	100	300									
			BL	200	600									
			BLL	200	400									
			YH	75	150									
			GRL	100	200									
GRH	150	300												
TLP188 *		SO6 (reinforced insulation) High V_{CE0} $V_{CE0} = 350\text{ V}$	—	50	600	5/5	350	3750	○	○	□	△	○	
TLP290 (SE) *		SO4 (reinforced insulation) AC input Lead pitch: 1.27 mm	—	50	600	$\pm 5/5$	80	3750	○	○	△	□	○	△
			Y	50	150									
			GR	100	300									
			BL	200	600									
			GB	100	600									
TLP291 (SE) *		SO4 (reinforced insulation) Lead pitch: 1.27 mm	—	50	600	5/5	80	3750	○	○	△	□	○	△
			GB	100	600									
			Y	50	150									
			GR	100	300									
			BLL	200	400									
			YH	75	150									
			GRL	100	200									
GRH	150	300												
TLP292 *		SO4 (reinforced insulation) AC input Low input drive current	—	50	600	$\pm 0.5/5$	80	3750	○	○	□		△	
			Y	50	150									
			GR	100	300									
			BL	200	600									
			GB	100	600									
TLP293 *		SO4 (reinforced insulation) Low input drive current	—	50	600	0.5/5	80	3750	○	○	□		△	
			GB	100	600									
			Y	50	150									
			GR	100	300									
			BL	200	600									
			YH	75	150									
			GRL	100	200									
			GRH	150	300									
BLL	200	400												

Note (1): Please refer to page 48.

*: New product

3 Selection Guide

General-Purpose, Transistor-Output Photocouplers

Part Number	Pin Configuration	Features	CTR				V _{CEO} (V)	BV _s 1 Minute (V _{rms})	Safety Standards ⁽¹⁾						
			Rank	Min (%)	Max (%)	@I _F / V _{CE} (mA) (V)			UL	c-UL	TÜV	VDE	BSI	CQC	
TLP124		Mini-flat MFSOP6 Low input drive current	—	100	1200	1/0.5	80	3750	○	○					
			BV	200											
TLP131		Mini-flat MFSOP6 General-purpose Internal base connection	—	50	600	5/5	80	3750	○	○					
			GB	100											
TLP137		Mini-flat MFSOP6 Low input drive current Internal base connection	—	100	1200	1/0.5	80	3750	○	○					
			BV	200											
TLP281-4		SOP16 4-channel version Lead pitch: 1.27 mm SEMKO-approved	—	50	600	5/5	80	2500	○	○	△	○	◎		
			GB	100											
TLP291-4		SO16 4-channel version equivalent of the TLP291 Lead pitch: 1.27 mm	—	50	400	5/5	80	2500	○	○	△	○		△	
			GB	100											400
TLP293-4 *		SO16 4-channel version equivalent of the TLP293 Lead pitch: 1.27 mm Low input drive current	—	50	600	0.5/5	80	3750	○	○		□		△	
			GB	100											
TLP331		DIP6 Low input drive current Internal base connection	—	100	1200	1/0.5	55	5000	○	○					
			BV	200											
TLP332		DIP6 Low input drive current No internal base connection	—	100	1200	1/0.5	55	5000	○	○					
			BV	200											
TLP385 *		SO6L Long creepage and clearance distance ≥ 8.0 mm (min)	—	50	600	5/5	80	5000	○	○		□		△	
			GB	100											
			Y	50											150
			GR	100											300
			BL	200											600
			YH	75											150
			GRL	100											200
			GRH	150											300
BLL	200	400													
TLP531 ⁽²⁾		DIP6 General-purpose Internal base connection	—	50	600	5/5	55	2500	○	○					
			GB	100											
			BL	200											
			GR	100											300
			Y	50											150
TLP532 ⁽²⁾		DIP6 General-purpose High EMI immunity No internal base connection	—	50	600	5/5	55	2500	○	○					
			GB	100											
			BL	200											
			GR	100											300
			Y	50											150
TLP624		DIP4 Low input drive current	—	100	1200	1/0.5	55	5000	○	○	△	○	◎		
			BV	200											

Note (1),(2): Please refer to page 48.

*: New product

General-Purpose, Transistor-Output Photocouplers (Continued)

Part Number	Pin Configuration	Features	CTR				V _{CEO} (V)	BV _s 1 Minute (V _{rms})	Safety Standards ⁽¹⁾					
			Rank	Min (%)	Max (%)	@I _F / V _{CE} (mA) (V)			UL	c-UL	TÜV	VDE	BSI	CQC
TLP628		DIP4 High V _{CEO} V _{CEO} = 350 V	—	50	600	5/5	350	5000	○	○	△	○	△	
			GB	100										
TLP631		DIP6 General-purpose Internal base connection	—	50	600	5/5	55	5000	○	○				
			GB	100										
			GR	100	300									
TLP632		DIP6 General-purpose High EMI immunity No internal base connection	—	50	600	5/5	55	5000	○	○				
			GB	100										
			GR	100	300									
TLP731		DIP6 SEMKO-approved Internal base connection	—	50	600	5/5	55	4000	○	○	△	○	◎	
			GB	100										
			GR	100	300									
TLP732		DIP6 SEMKO-approved No internal base connection	—	50	600	5/5	55	4000	○	○	△	○	◎	
			GB	100										
			GR	100	300									
TLP733 TLP733F		DIP6 SEMKO-approved Internal base connection	—	50	600	5/5	55	4000	○	○	△	○	◎	
			GB	100										
			GR	100	300									
TLP734 TLP734F		DIP6 SEMKO-approved No internal base connection	—	50	600	5/5	55	4000	○	○	△	○	◎	
			GB	100										
			GR	100	300									
TLP785 ⁽³⁾ TLP785F ⁽³⁾		DIP4 High isolation voltage UL-approved (double protection)	—	50	600	5/5	80	5000	○	○	△	○	◎	○
			Y	50	150									
			GR	100	300									
			BL	200	600									
			GB	100										
			YH	75	150									
			GRL	100	200									
			GRH	150	300									
BLL	200	400												

Note (1),(3): Please refer to page 48.

3 Selection Guide

AC-Input, Transistor-Output Photocouplers

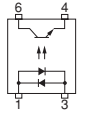
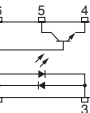
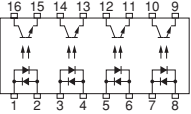
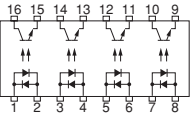
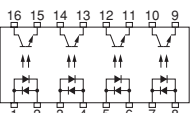
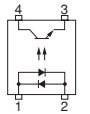
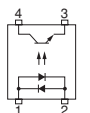
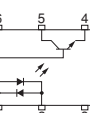
Part Number	Pin Configuration	Features	CTR				V _{CEO} (V)	BV _s 1 Minute (V _{rms})	Safety Standards ⁽¹⁾						
			Rank	Min (%)	Max (%)	@ I _F / V _{CE} (mA) (V)			UL	c-UL	TÜV	VDE	BSI	CQC	
TLP126		Mini-flat MFSOP6 AC input Low input drive current	—	100	1200	±1/0.5	80	3750	○	○					
TLP130		Mini-flat MFSOP6 AC input Internal base connection	—	50	600	±5/5	80	3750	○	○					
			GB	100											
TLP280-4		SOP16 4-channel version Lead pitch: 1.27 mm AC input SEMKO-approved	—	50	600	±5/5	80	2500	○	○	△	○	◎		
			GB	100											
TLP290-4		SO16 4-channel version equivalent of the TLP290 Lead pitch: 1.27 mm AC input	—	50	400	±5/5	80	2500	○	○	△	○			△
			GB	100											
TLP292-4 *		SO16 4-channel version equivalent of the TLP292 Lead pitch: 1.27 mm Low input drive current AC input	—	50	600	±0.5/5	80	3750	○	○		□			△
			GB	100											
TLP620 TLP620F		DIP4 AC input SEMKO-approved	—	50	600	±5/5	55	5000	○	○	△	○	◎		
			GB	100											
TLP626		DIP4 Low input drive current AC input	—	100	1200	±1/0.5	55	5000	○	○	△	○	◎		
			BV	200											
TLP630		DIP6 AC input High isolation voltage	—	50	600	±5/5	55	5000	○						
			GB	100											

Note (1): Please refer to page 48.

*: New product



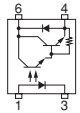
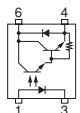
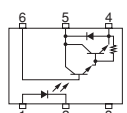
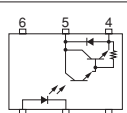
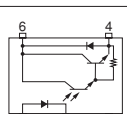
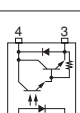
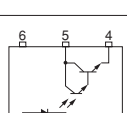
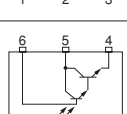
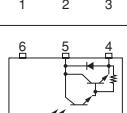
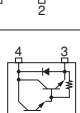



Darlington-Transistor-Output Photocouplers

Part Number	Pin Configuration	Features	CTR		V _{CE(sat)}		V _{CEO} (V)	BV _s 1 Minute (V _{rms})	Safety Standards ⁽¹⁾					
			Min (%)	@I _F / V _{CE} (mA) (V)	Max (V)	@I _C / I _F (mA)			UL	c-UL	TÜV	VDE	BSI	CQC
TLP127		Mini-flat MFSOP6 High V _{CEO}	1000	1/1	1.2	100/10	300	2500	○	○	○	○	◎	
TLP187		SO6 (reinforced insulation) High V _{CEO}	1000	1/1	1.2	100/10	300	3750	○	○		□	△	△
TLP371		DIP6 High V _{CEO} SEMKO-approved	1000	1/1	1.2	100/10	300	5000	○	○				○
TLP372		DIP6 High V _{CEO} No internal base connection	1000	1/1	1.2	100/10	300	5000	○	○				
TLP373		DIP6 High V _{CEO} Long emitter-collector distance	1000	1/1	1.2	100/10	300	5000	○	○				
TLP523		DIP4 General-purpose	500	1/1	1.0	50/10	55	2500	○	○				
TLP570		DIP6 General-purpose High EMI immunity	1000	1/1	1.2	100/10	35	2500	○	○				
TLP571		DIP6 General-purpose Internal base connection	1000	1/1	1.2	100/10	35	2500	○					
TLP572		DIP6 General-purpose Built-in R _{BE}	1000	1/1.2	1.2	100/10	55	2500	○					
TLP627		DIP4 High V _{CEO} SEMKO-approved	1000	1/1	1.2	100/10	300	5000	○	○	△	○	◎	

Note (1): Please refer to page 48.

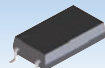
3 Selection Guide

2 Photocouplers for Logic Signal Transmission

Package										
Data Rate (Typ.)	Output	MFSOP6	SO6	SO8		SO6L	SDIP6	DIP8		JEDEC
				1ch	2ch			1ch	2ch	
20 kbit/s	Open-collector		TLP2301							
0.1 to 0.3 Mbit/s	Open-collector (Darlington)		TLP2303	TLP2403		TLP2703		TLP553		6N138 6N139
1 Mbit/s	Open-collector		TLP109 TLP2309	TLP2409			TLP719	TLP550 TLP551 TLP559 TLP651 TLP750 TLP751 TLP759	TLP2530 TLP2531	6N135 6N136
		IPM drive	TLP109(IGM) TLP104	TLP2404			TLP714	TLP559(IGM) TLP759(IGM) TLP754		
5 Mbit/s	Totem-pole		TLP2355 TLP2358 TLP2310**	TLP2405 TLP2408	TLP2105 TLP2108		TLP715 TLP718	TLP2955 TLP2958		
		AC input	TLP2095 TLP2098	TLP2395* TLP2398*						
	3-state							TLP555 TLP558 TLP2200		
10 Mbit/s	Totem-pole		TLP2345* TLP2348*							
	AC input		TLP2391*							
10 Mbit/s	Open-collector		TLP2362					TLP552 TLP554 TLP2601 TLP2962 TLPN137	TLP2630 TLP2631 TLP2662	6N137
15 to 20 Mbit/s	Totem-pole	5 V		TLP116A		TLP2116		TLP716		
		3.3 V	TLP2066			TLP2166A				
	3.3/5 V		TLP2361* TLP2366	TLP2466	TLP2160 TLP2161*		TLP2766			
	Open-collector	5 V		TLP118	TLP2418	TLP2118E		TLP708		
3.3/5 V			TLP2368	TLP2468	TLP2168	TLP2768A**	TLP2768			
40 Mbit/s	Totem-pole	3.3/5 V		TLP2367**		TLP2167**		TLP2767**		
50 Mbit/s	Totem-pole	5 V	TLP117							

*: New product **: Under development

Photocouplers for Logic Signal Transmission at 20 kbit/s (Typ.)

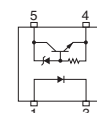
Part Number	Pin Configuration	Features	Data Rate (Typ. @NRZ)	Output/CTR	@I _{F(IN)} (mA)	BV _s 1 Minute (V _{rms})	Safety Standards (1)					
							UL	c-UL	TÜV	VDE	BSI	CQC
TLP2301		SO6 (4 pin) (reinforced insulation) Low input drive current	20k bit/s	50% Min	1	3750	○	○	□		○	

Note (1): Please refer to page 48.

Photocouplers for Logic Signal Transmission at 0.1 to 0.3 Mbit/s (Typ.)

Part Number	Pin Configuration	Features	Data Rate (Typ. @NRZ)	Output/CTR	@I _{F(IN)} (mA)	BV _s 1 Minute (V _{rms})	Safety Standards ⁽¹⁾					
							UL	c-UL	TÜV	VDE	BSI	CQC
TLP2303		SO6 (reinforced insulation) Low input drive current	100k bit/s	900% Min	0.5	3750	○	○		□		△
TLP2703 *		SO6L (reinforced insulation) Low input drive current	100k bit/s	900% Min	0.5	5000	△	△		△		△
TLP2403		SO8 Low input drive current SO8 version of the TLP553	300k bit/s	400% Min	0.5	3750	○	○		○		
TLP553		DIP8 Low input drive current	300k bit/s	400% Min	0.5	2500	○					

Note (1): Please refer to page 48.

*: New product

Photocouplers for Logic Signal Transmission at 1 Mbit/s (Typ.)

Part Number	Pin Configuration	Features	Data Rate (Typ. @NRZ)	Output/CTR	@I _{F(IN)} (mA)	BV _s 1 Minute (V _{rms})	Safety Standards ⁽¹⁾					
							UL	c-UL	TÜV	VDE	BSI	CQC
TLP109		SO6 (reinforced insulation)	1M bit/s	20% Min	16	3750	○	○	△	□		△
TLP2309		SO6 (reinforced insulation) 3.3-V/5-V power supplies T _{opr} (max) 110°C 1 Mbps standard	1M bit/s	15% Min	10	3750	○	○		□		△
TLP2409		SO8 T _{opr} (max) 125°C SO8 version of the TLP109	1M bit/s	20% Min	16	3750	○	○		○		
TLP719 TLP719F		SDIP6 High CMR	1M bit/s	20% Min	16	5000	○	○	○	○		
TLP512		DIP6 6-pin package version of the TLP550	1M bit/s	20% Min	16	2500	○					
TLP550		DIP8 No internal base connection High CMR	1M bit/s	10% min (19% (min) for rank O)	16	2500	○	○				

Note (1): Please refer to page 48.

3 Selection Guide

Photocouplers for Logic Signal Transmission at 1 Mbit/s (Typ.) (Continued)

Part Number	Pin Configuration	Features	Data Rate (Typ. @NRZ)	Output/CTR	@I _{F(IN)} (mA)	BVs 1 Minute (V _{rms})	Safety Standards ⁽¹⁾					
							UL	c-UL	TÜV	VDE	BSI	CQC
TLP551		DIP8 Internal base connection	1M bit/s	10% min (19% (min) for rank O)	16	2500	○	○				
TLP559		DIP8 High CMR version of the TLP550 No internal base connection	1M bit/s	20% Min	16	2500	○	○				
TLP651		DIP8 High isolation voltage Internal base connection	1M bit/s	10% min (19% (min) for rank O)	16	5000	○	○				
TLP750 TLP750F		DIP8 High isolation voltage SEMKO-approved	1M bit/s	10% min (19% (min) for rank O)	16	5000	○	○	△	○	◎	
TLP751 TLP751F		DIP8 High isolation voltage Internal base connection SEMKO-approved	1M bit/s	10% Min	16	5000	○	○	△	○	◎	
TLP759 TLP759F		DIP8 IEC950 design standard version of the TLP559 SEMKO-approved	1M bit/s	20% Min	16	5000	○	○	○	○	◎	
TLP2530		DIP8 Dual channel version of the 6N135 and the TLP550	1M bit/s	7% Min	16	2500	○	○				
TLP2531		DIP8 Dual channel version of the 6N136 and the TLP550	1M bit/s	19% Min	16	2500	○	○				

Note (1): Please refer to page 48.

Photocouplers for Logic Signal Transmission at 5 Mbit/s (Typ.)

Part Number	Pin Configuration	Features	Data Rate (Typ. @NRZ)	Output/CTR	@IF(IN) (mA)	BVs 1 Minute (Vrms)	Safety Standards ⁽¹⁾					
							UL	c-UL	TÜV	VDE	BSI	CQC
TLP2095		Mini-flat MFSOP6 Vcc = 3.0 to 20 V	5M bit/s	Totempole output (Buffer logic)	IFLH = 3 (max)	3750	○	○		○		
TLP2098		Mini-flat MFSOP6 Vcc = 3.0 to 20 V	5M bit/s	Totempole output (Inverter logic)	IFHL = 3 (max)	3750	○	○		○		
TLP2355		SO6 (reinforced insulation) Vcc = 3.0 to 20 V Direct drive of an IPM	5M bit/s	Totempole output (Buffer logic)	IFLH = 1.6 (max)	3750	○	○		□		△
TLP2358		SO6 (reinforced insulation) Vcc = 3.0 to 20 V Direct drive of an IPM	5M bit/s	Totempole output (Inverter logic)	IFHL = 1.6 (max)	3750	○	○		□		△
TLP2310 **		SO6 (reinforced insulation) Ultra low consumption	5M bit/s	Totempole output (Buffer logic)	IFLH = 1.0 (max)	3750	△	△		△		△
TLP2395 *		SO6 AC input version of the TLP2355 Vcc = 3.0 to 20 V	5M bit/s	Totempole output (Buffer logic)	IFHL = 2.3 (max)	3750	○	○		□		△
TLP2398 *		SO6 AC input version of the TLP2358 Vcc = 3.0 to 20 V	5M bit/s	Totempole output (Inverter logic)	IFHL = 2.3 (max)	3750	○	○		□		△
TLP2405		SO8 Low input current SO8 version of the TLP105 Direct drive of an IPM	5M bit/s	Totempole output (Buffer logic)	IFLH = 1.6 (max)	3750	○	○		○		
TLP2408		SO8 Low input current SO8 version of the TLP108 Direct drive of an IPM	5M bit/s	Totempole output (Inverter logic)	IFHL = 1.6 (max)	3750	○	○		○		
TLP2105		SO8 Dual channel version of the TLP105	5M bit/s	Totempole output (Buffer logic)	IFLH = 1.6 (max)	2500	○	○	△	○		
TLP2108		SO8 Dual channel version of the TLP108	5M bit/s	Totempole output (Inverter logic)	IFHL = 1.6 (max)	2500	○	○	△	○		
TLP715 TLP715F		SDIP6 High CMR Direct drive of an IPM	Propagation delay time 250 ns (max)	Totempole output (Buffer logic)	IFLH = 3 (max)	5000	○	○	○	○		

Note (1): Please refer to page 48.

*: New product **: Under development

3 Selection Guide

Photocouplers for Logic Signal Transmission at 5 Mbit/s (Typ.) (Continued)

Part Number	Pin Configuration	Features	Data Rate (Typ. @NRZ)	Output/CTR	@I _{F(IN)} (mA)	BV _s 1 Minute (V _{rms})	Safety Standards ⁽¹⁾					
							UL	c-UL	TÜV	VDE	BSI	CQC
TLP718 TLP718F		SDIP6 High CMR Direct drive of an IPM	Propagation delay time 250 ns (max)	Totempole output (Inverter logic)	I _{FLH} = 3 (max)	5000	○	○	○	○		
TLP2955 TLP2955F		DIP8 Topr (max) 125°C Low input current V _{cc} = 3.0 to 20 V Direct drive of an IPM	5M bit/s	Totempole output (Buffer logic)	I _{FLH} = 1.6 (max)	5000	△	△		□		
TLP2958 TLP2958F		DIP8 Topr (max) 125°C Low input current V _{cc} = 3.0 to 20 V Direct drive of an IPM	5M bit/s	Totempole output (Inverter logic)	I _{FLH} = 1.6 (max)	5000	△	△		□		
TLP555		DIP8 Low input current High V _{cc} operation	5M bit/s	3-state output (Buffer logic)	I _{FLH} = 1.6 (max)	2500	○	○				
TLP558		DIP8 Inverted logic version of the TLP555	5M bit/s	3-state output (Inverter logic)	I _{FLH} = 1.6 (max)	2500	○	○				
TLP2200		DIP8 Low input current High-speed High V _{cc} operation	5M bit/s	3-state output (Buffer logic)	I _{FLH} = 1.6 (max)	2500	○	○				

Note (1): Please refer to page 48.

Photocouplers for Logic Signal Transmission at 10 Mbit/s (Typ.)

Part Number	Pin Configuration	Features	Data Rate (Typ. @NRZ)	Output/CTR	@ I _{F(IN)} (mA)	BVs 1 Minute (V _{rms})	Safety Standards ⁽¹⁾					
							UL	c-UL	TÜV	VDE	BSI	CQC
TLP2345 *		SO6 (reinforced insulation) High-speed Direct drive of an IPM	10M bit/s	Totempole output (Buffer logic)	I _{FHL} = 1.6 (max)	3750	△	△		□		
TLP2348 *		SO6 (reinforced insulation) High-speed Direct drive of an IPM	10M bit/s	Totempole output (Inverter logic)	I _{FHL} = 1.6 (max)	3750	△	△		□		
TLP2391 *		SO6 (reinforced insulation) 3.3-V/5-V power supplies AC input version of the TLP2361	10M bit/s	Totempole output (Inverter logic)	I _{FHL} = 2.3 (max)	3750	○	○		□		
TLP2362		SO6 (reinforced insulation) Topr (max) 125°C 10 Mbps standard	10M bit/s	Open-collector output (Inverter logic)	I _{FHL} = 5 (max)	3750	○	○		□		△
TLP513		DIP6 6-pin package version of the TLP552	10M bit/s	Open-collector output (Inverter logic)	I _{FHL} = 5 (max)	2500	○					
TLP552		DIP8 High-speed	10M bit/s	Open-collector output (Inverter logic)	I _{FHL} = 5 (max)	2500	○					
TLP554		DIP8 High-speed High CMR version of the TLP552	10M bit/s	Open-collector (Inverter logic)	I _{FHL} = 5 (max)	2500	○	○		○		
TLP2601		DIP8 High CMR High-speed	10M bit/s	Open-collector output (Inverter logic)	I _{FHL} = 5 (max)	2500	○	○				
TLP2962 TLP2962F		DIP8 3.3-V/5-V power supplies Topr (max) 125°C	10M bit/s	Open-collector output (Inverter logic)	I _{FHL} = 5 (max)	5000	○	○		□		
TLPN137		DIP8 High-speed	10M bit/s	Open-collector output (Inverter logic)	I _{FHL} = 5 (max)	5000	○	○		□		△
TLP2630		DIP8 Dual channel version of the GN137 and the TLP552	10M bit/s	Open-collector output (Inverter logic)	I _{FHL} = 5 (max)	2500	○	○				
TLP2631		DIP8 High CMR Dual channel version of the TLP554	10M bit/s	Open-collector output (Inverter logic)	I _{FHL} = 5 (max)	2500	○	○				
TLP2662 TLP2662F		DIP8 3.3-V/5-V power supplies Topr (max) 125°C Dual channel version of the TLP2962	10M bit/s	Open-collector output (Inverter logic)	I _{FHL} = 5 (max)	5000	△	△		□		

Note (1): Please refer to page 48.

*: New product

3 Selection Guide

Photocouplers for Logic Signal Transmission at 15 to 20 Mbit/s (Typ.)

Part Number	Pin Configuration	Features	Data Rate (Typ. @NRZ)	Output/CTR	@IF(IN) (mA)	BVs 1 Minute (Vrms)	Safety Standards ⁽¹⁾					
							UL	c-UL	TÜV	VDE	BSI	CQC
TLP2066		Mini-flat MFSOP6 3.3-V power supply	20M bit/s	Totem-pole output (Inverter logic)	IFHL = 5 (max)	3750	○		○	○		○
TLP116A		SO6 (reinforced insulation) Ultra-high-speed	20M bit/s	Totem-pole output (Inverter logic)	IFHL = 5 (max)	3750	○	○	△	○		○
TLP2361 *		SO6 (reinforced insulation) 3.3-V/5-V power supplies Topr (max) 125°C Low input current Low power consumption	15M bit/s	Totem-pole output (Inverter logic)	IFHL = 1.6 (max)	3750	○	○		□		△
TLP2366		SO6 (reinforced insulation) 3.3-V/5-V power supplies Topr (max) 125°C	20M bit/s	Totem-pole output (Inverter logic)	IFHL = 3.5 (max)	3750	○	○		□		△
TLP118		SO6 (reinforced insulation) Topr (max) 125°C Ultra-high-speed	20M bit/s	Open-collector output (Inverter logic)	IFHL = 5 (max)	3750	○	○		□		△
TLP2368		SO6 (reinforced insulation) Topr (max) 125°C Ultra-high-speed 20 Mbps standard	20M bit/s	Open-collector output (Inverter logic)	IFHL = 5 (max)	3750	○	○		□		△
TLP2466		SO8 3.3-V/5-V power supplies Topr (max) 125°C	20M bit/s	Totem-pole output (Inverter logic)	IFHL = 3.5 (max)	3750	○	○		○		
TLP2418		SO8 Topr (max) 125°C High-speed SO8 version of the TLP118	20M bit/s	Open-collector output (Inverter logic)	IFHL = 5 (max)	3750	○	○		○		
TLP2468		SO8 3.3-V/5-V power supplies Topr (max) 125°C	20M bit/s	Open-collector output (Inverter logic)	IFHL = 5 (max)	3750	○	○		○		
TLP2116		SO8 Dual channel version equivalent of the TLP116A	15M bit/s	Totem-pole output (Inverter logic)	IFHL = 5 (max)	2500	○	○	○	○		
TLP2166A		SO8 3.3-V power supply Dual channel version equivalent for the TLP2366	15M bit/s	Totem-pole output (Inverter logic)	IFHL = 3 (max)	2500	○	○	△	○		
TLP2160		2 channels in SO8 3.3-V/5-V power supplies Topr (max) 125°C	20M bit/s	Totem-pole output (Inverter logic)	IFHL = 3.5 (max)	2500	○	○		○		

Note (1): Please refer to page 48.

*: New product

Photocouplers for Logic Signal Transmission at 15 to 20 Mbit/s (Typ.) (Continued)

Part Number	Pin Configuration	Features	Data Rate (Typ. @NRZ)	Output/CTR	@ I _{F(IN)} (mA)	BV _s 1 Minute (V _{rms})	Safety Standards ⁽¹⁾					
							UL	c-UL	TÜV	VDE	BSI	CQC
TLP2161 *		2 channels in SO8 3.3-V/5-V power supplies Topr (max) 125°C Low input current Low power consumption	15M bit/s	Totempole output (Inverter logic)	I _{FHL} = 1.6 (max)	2500	○	○		○		
TLP2118E		SO8 Dual channel version equivalent for the TLP118	15M bit/s	Open-collector output (Inverter logic)	I _{FHL} = 5 (max)	2500	○	○		○		
TLP2168		SO8 3.3-V/5-V power supplies Topr (max) 125°C	20M bit/s	Open-collector output (Inverter logic)	I _{FHL} = 5 (max)	2500	○	○		○		
TLP716 TLP716F		SDIP6 High-speed SDIP version of the TLP116A	15M bit/s	Totempole output (Inverter logic)	I _{FHL} = 6.5 (max)	5000	○	○	○	○		
TLP2766 TLP2766F		SDIP6 3.3-V/5-V power supplies Topr (max) 125°C	20M bit/s	Totempole output (Inverter logic)	I _{FHL} = 3.5 (max)	5000	○	○		○		
TLP708 TLP708F		SDIP6 Topr (max) 125°C High-speed SDIP version of the TLP118	15M bit/s	Open-collector output (Inverter logic)	I _{FHL} = 5 (max)	5000	○	○		○		
TLP2768 TLP2768F		SDIP6 3.3-V/5-V power supplies Topr (max) 125°C	20M bit/s	Open-collector output (Inverter logic)	I _{FHL} = 5 (max)	5000	○	○		○		

Note (1): Please refer to page 48.

*: New product

3 Selection Guide

Photocouplers for Logic Signal Transmission at 40 Mbit/s (Typ.)

Part Number	Pin Configuration	Features	Data Rate (Typ. @NRZ)	Output/CTR	@IF(IN) (mA)	BVs 1 Minute (Vrms)	Safety Standards ⁽¹⁾					
							UL	c-UL	TÜV	VDE	BSI	CQC
TLP2367 **		SO6 (reinforced insulation) 3.3-V/5-V power supplies Topr (max) 125°C	40M bit/s	Totempole output (Inverter logic)	IFHL = 5 (max)	3750	△	△		△		
TLP2167 **		SO8 3.3-V/5-V power supplies Topr (max) 125°C	40M bit/s	Totempole output (Inverter logic)	IFHL = 5 (max)	2500	△	△		△		
TLP2767 ** TLP2767F **		SDIP6 3.3-V/5-V power supplies Topr (max) 125°C	40M bit/s	Totempole output (Inverter logic)	IFHL = 5 (max)	5000	△	△		△		

Note (1): Please refer to page 48.

** : Under development

Photocouplers for Logic Signal Transmission at 50 Mbit/s (Typ.)

Part Number	Pin Configuration	Features	Data Rate (Typ. @NRZ)	Output/CTR	@IF(IN) (mA)	BVs 1 Minute (Vrms)	Safety Standards ⁽¹⁾					
							UL	c-UL	TÜV	VDE	BSI	CQC
TLP117		Mini-flat MFSOP6 Ultra-high-speed	50M bit/s	Totempole output (Inverter logic)	IFHL = 5 (max)	3750	○	○	○	○		

Note (1): Please refer to page 48.

IPM-Drive Photocouplers

Part Number	Pin Configuration	Features	Data Rate (Typ. @NRZ)	Output/CTR	@IF(IN) (mA)	BVs 1 Minute (Vrms)	Safety Standards ⁽¹⁾					
							UL	c-UL	TÜV	VDE	BSI	CQC
TLP109(IGM)		SO6 (reinforced insulation) Direct drive of an IPM	Propagation delay time 0.8 μs (max)	25% Min	10	3750	○	○	△	□		△
TLP104		SO6 (reinforced insulation) Topr (max) 125°C Direct drive of an IPM	Propagation delay time 550 ns (max)	Open-collector output (Inverter logic)	IFHL = 5 (max)	3750	○	○		□		△
TLP2404		SO8 Topr (max) 125°C SO8 version of the TLP104 Direct drive of an IPM	Propagation delay time 550 ns (max)	Open-collector output (Inverter logic)	IFHL = 5 (max)	3750	○	○		○		
TLP714 TLP714F		SDIP6 SDIP version of the TLP104 Direct drive of an IPM	Propagation delay time 550 ns (max)	Open-collector output (Inverter logic)	IFHL = 5 (max)	5000	○	○		○		
TLP559(IGM)		DIP8 High CMR version of the TLP550 No internal base connection	Propagation delay time 0.8 μs (max)	25% Min	10	2500	○	○				

Note (1): Please refer to page 48.

IPM-Drive Photocouplers (Continued)

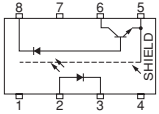
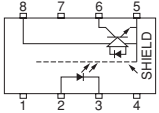
Part Number	Pin Configuration	Features	Data Rate (Typ. @NRZ)	Output/CTR	@I _{F(IN)} (mA)	BV _s 1 Minute (V _{rms})	Safety Standards ⁽¹⁾					
							UL	c-UL	TÜV	VDE	BSI	CQC
TLP759(IGM) TLP759F(IGM)		DIP8 IEC950 design standard version of the TLP559 SEMKO-approved Direct drive of an IPM	Propagation delay time 0.8 μs (max)	25% Min	10	5000	○	○	○	○	○	
TLP754 TLP754F		DIP8 DIP8 version of the TLP104 Direct drive of an IPM	Propagation delay time 550 ns (max)	Open-collector output (Inverter logic)	I _{FHL} = 5 (max)	5000	○	○		□		

Note (1): Please refer to page 48.



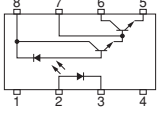
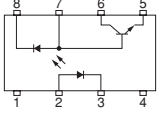
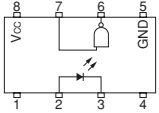

JEDEC-Compliant Photocouplers

Part Number	Pin Configuration	Features	Data Rate (Typ. @NRZ)	Output/CTR	@I _{F(IN)} (mA)	BV _s 1 Minute (V _{rms})	Safety Standards ⁽¹⁾					
							UL	c-UL	TÜV	VDE	BSI	CQC
6N138		DIP8 JEDEC-compliant High CTR	300k bit/s	300% Min	1.6	2500	○					
6N139				400% Min	0.5	2500	○					
6N135		DIP8 JEDEC-compliant	1M bit/s	7% Min	16	2500	○					
6N136				19% Min	16	2500	○					○
6N137		DIP8 JEDEC-compliant High-speed	10M bit/s	700% Typ.	5	2500	○					

Note (1): Please refer to page 48.

3 Selection Guide

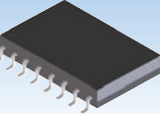
3 Photocouplers for IGBT/MOSFET Gate Drive

Package Output Peak Current						
	SO6	SO8	SO6L	SO16L	SDIP6	DIP8
±0.3 A (max)						TLP557
±0.45 A (max)						
±0.6 A (max)	TLP151A, TLP155 TLP155E	TLP2451A	TLP5701		TLP701, TLP701A TLP701H, TLP705A	TLP351, TLP351A TLP351H
±1.0 A (max)			TLP5751*			
±2.0 A (max)					TLP700	
±2.5 A (max)	TLP152*		TLP5702 TLP5752*		TLP700A TLP700H	TLP250H, TLP350 TLP350H, TLP352
±4.0 A (max)			TLP5754*	TLP5214*		
±6.0 A (max)						TLP358 TLP358H

*: New product

Photocouplers for IGBT/MOSFET Gate Drive

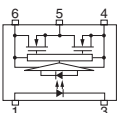
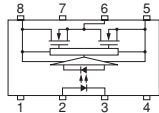
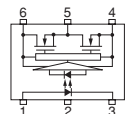
Part Number	Pin Configuration	Features	Data Rate (Typ. @NRZ)	Output/CTR	@I _{F(IN)} (mA)	BV _s 1 Minute (V _{rms})	Safety Standards ⁽¹⁾					
							UL	c-UL	TÜV	VDE	BSI	CQC
TLP151A		SO6 (reinforced insulation) Topr (max) 110°C Direct drive of a small- power IGBT/MOSFET	Propagation delay time 0.5 μs (max)	Peak output current: ±0.6 A (max)	I _{FLH} = 5 (max)	3750	○	○		□		
TLP155 TLP155E		SO6 (reinforced insulation) Topr (max) 100°C Direct drive of a small- power IGBT/MOSFET	Propagation delay time 0.2 μs (max)	Peak output current: ±0.6 A (max)	I _{FLH} = 7.5 (max)	3750	○	○		□		△
TLP152		SO6 (reinforced insulation) Topr (max) 100°C Direct drive of a medium- power IGBT/MOSFET	Propagation delay time 0.19 μs (max)	Peak output current: ±2.5 A (max)	I _{FLH} = 7.5 (max)	3750	○	○		□		△
TLP2451A		SO8 Direct drive of a small- power IGBT/MOSFET Low power dissipation Topr (max) 125°C SO8 version of the TLP351A	Propagation delay time 0.5 μs (max)	Peak output current: ±0.6 A (max)	I _{FLH} = 5 (max)	3750	○	○		○		
TLP5701		SO6L Direct drive of a medium- power IGBT/MOSFET Topr (max) 110°C SO6L version of the TLP351A	Propagation delay time 0.5 μs (max)	Peak output current: ±0.6 A	I _{FLH} = 5 (max)	5000	○	○		△		△

Note (1): Please refer to page 48.

Photocouplers for IGBT/MOSFET Gate Drive (Continued)

Part Number	Pin Configuration	Features	Data Rate (Typ. @NRZ)	Output/CTR	@I _{F(IN)} (mA)	BVs 1 Minute (V _{rms})	Safety Standards ⁽¹⁾					
							UL	c-UL	TÜV	VDE	BSI	CQC
TLP5751 *		SO6L Direct drive of a medium-power IGBT/MOSFET Topr (max) 110°C Rail to Rail output	Propagation delay time 0.15 µs (max)	Peak output current: ±1.0 A	I _{FLH} = 4 (max)	5000	○	○		□		○
TLP5702		SO6L Direct drive of a medium-power IGBT/MOSFET Low power dissipation Topr (max) 110°C SO6L version of the TLP352	Propagation delay time 0.2 µs (max)	Peak output current: ±2.5 A	I _{FLH} = 5 (max)	5000	○	○		□		○
TLP5752 *		SO6L Direct drive of a medium-power IGBT/MOSFET Topr (max) 110°C Rail to Rail output	Propagation delay time 0.15 µs (max)	Peak output current: ±2.5 A	I _{FLH} = 4 (max)	5000	○	○		□		○
TLP5754 *		SO6L Direct drive of a medium-power IGBT/MOSFET Topr (max) 110°C Rail to Rail output	Propagation delay time 0.15 µs (max)	Peak output current: ±4.0 A	I _{FLH} = 4 (max)	5000	○	○		□		○
TLP5214 *		SO16L Smart gate drive photocoupler Overcurrent protection Soft shutdown Direct drive of a medium-power IGBT/MOSFET Topr (max) 110°C Rail to Rail output Active miller clamp	Propagation delay time 0.15 µs (max)	Peak output current: ±4.0 A	I _{FLH} = 6 (max)	5000	△	△		△		△
TLP701 TLP701F		SDIP6 Direct drive of a small-power IGBT/MOSFET Low power dissipation SDIP version of the TLP351	Propagation delay time 0.7 µs (max)	Peak output current: ±0.6 A (max)	I _{FLH} = 5 (max)	5000	○	○	○	○		
TLP701A TLP701AF		SDIP6 Direct drive of a small-power IGBT/MOSFET Low power dissipation SDIP version of the TLP351A	Propagation delay time 0.5 µs (max)	Peak output current: ±0.6 A (max)	I _{FLH} = 5 (max)	5000	○	○		○		
TLP701H TLP701HF		SDIP6 Direct drive of a small-power IGBT/MOSFET Low power dissipation Topr (max) 125°C SDIP version of the TLP351H	Propagation delay time 0.7 µs (max)	Peak output current: ±0.6 A (max)	I _{FLH} = 5 (max)	5000	○	○		○		
TLP705A TLP705AF		SDIP6 Direct drive of a small-power IGBT/MOSFET High-speed Low power dissipation	Propagation delay time 0.2 µs (max)	Peak output current: ±0.6 A (max)	I _{FLH} = 7.5 (max)	5000	○	○		○		

Note (1): Please refer to page 48.

*: New product

3 Selection Guide

Photocouplers for IGBT/MOSFET Gate Drive (Continued)

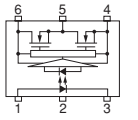
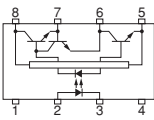
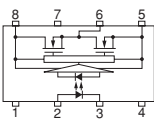
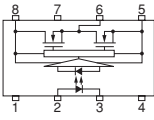
Part Number	Pin Configuration	Features	Data Rate (Typ. @NRZ)	Output/CTR	@I _{F(IN)} (mA)	BVs 1 Minute (V _{rms})	Safety Standards ⁽¹⁾					
							UL	c-UL	TÜV	VDE	BSI	CQC
TLP700 TLP700F		SDIP6 Direct drive of a medium-power IGBT/MOSFET Low power dissipation SDIP version of the TLP350	Propagation delay time 0.5 μs (max)	Peak output current: ±2.0 A (max)	I _{FLH} = 5 (max)	5000	○	○	○	○		
TLP700A TLP700AF		SDIP6 Direct drive of a medium-power IGBT/MOSFET SDIP version of the TLP352	Propagation delay time 0.2 μs (max)	Peak output current: ±2.5 A (max)	I _{FLH} = 5 (max)	5000	○	○		○		△
TLP700H TLP700HF		SDIP6 Direct drive of a medium-power IGBT/MOSFET Low power dissipation Topr (max) 125°C SDIP version of the TLP350H	Propagation delay time 0.5 μs (max)	Peak output current: ±2.5 A (max)	I _{FLH} = 5 (max)	5000	○	○		○		
TLP557		DIP8 Direct drive of a power transistor	Propagation delay time 5 μs (max)	Constant current output: 0.25 A	I _{FLH} = 5 (max)	2500	○	○				
TLP351 TLP351F		DIP8 Direct drive of a small-power IGBT/MOSFET Low power dissipation	Propagation delay time 0.7 μs (max)	Peak output current: ±0.6 A (max)	I _{FLH} = 5 (max)	3750	○	○	○	○		
TLP351A TLP351AF		DIP8 Direct drive of a small-power IGBT/MOSFET Low power dissipation	Propagation delay time 0.5 μs (max)	Peak output current: ±0.6 A (max)	I _{FLH} = 5 (max)	3750	○	○		○		△
TLP351H TLP351HF		DIP8 Direct drive of a small-power IGBT/MOSFET Low power dissipation Topr (max) 125°C	Propagation delay time 0.7 μs (max)	Peak output current: ±0.6 A (max)	I _{FLH} = 5 (max)	3750	○	○		□		△
TLP250H TLP250HF		DIP8 Direct drive of a medium-power IGBT/MOSFET Wide V _{cc} 10 to 30 V Topr (max) 125°C	Propagation delay time 0.5 μs (max)	Peak output current: ±2.5 A (max)	I _{FLH} = 5 (max)	3750	○	○		□		
TLP350 TLP350F		DIP8 Direct drive of a medium-power IGBT/MOSFET Low power dissipation	Propagation delay time 0.5 μs (max)	Peak output current: ±2.5 A (max)	I _{FLH} = 5 (max)	3750	○	○	○	○		○

Note (1): Please refer to page 48.

Photocouplers for IGBT/MOSFET Gate Drive (Continued)

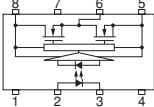
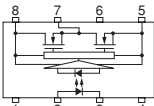
Part Number	Pin Configuration	Features	Data Rate (Typ. @NRZ)	Output/CTR	@I _{F(IN)} (mA)	BVs 1 Minute (V _{rms})	Safety Standards ⁽¹⁾					
							UL	c-UL	TÜV	VDE	BSI	CQC
TLP350H TLP350HF		DIP8 Direct drive of a medium-power IGBT/MOSFET Low power dissipation Topr (max) 125°C	Propagation delay time 0.5 μs (max)	Peak output current: ±2.5 A (max)	I _{FLH} = 5 (max)	3750	○	○		□		△
TLP352 TLP352F		DIP8 Direct drive of a medium-power IGBT/MOSFET Low power dissipation Topr (max) 125°C	Propagation delay time 0.2 μs (max)	Peak output current: ±2.5 A (max)	I _{FLH} = 5 (max)	3750	○	○		□		△
TLP358 TLP358F		DIP8 Direct drive of a medium-power IGBT/MOSFET Low power dissipation	Propagation delay time 0.5 μs (max)	Peak output current: ±6 A (max)	I _{FLH} = 5 (max)	3750	○	○	○	□		
TLP358H TLP358HF		DIP8 Direct drive of a medium-power IGBT/MOSFET Low power dissipation Topr (max) 125°C	Propagation delay time 0.5 μs (max)	Peak output current: ±6 A (max)	I _{FLH} = 5 (max)	3750	○	○	○	□		△

Note (1): Please refer to page 48.











3 Selection Guide

4 Photorelays (1-Form-A and 2-Form-A)

Package													
			Features										
Off-State Voltage (max) (V)	On-State Resistance (max) (Ω)	On-State Current (max) (A)	VSON4	USOP4	SSOP4	SO6	2.54SOP4	2.54SOP6	2.54SOP8	DIP4	DIP6	DIP8	
20	8	0.16		TLP3330*	TLP3230		TLP3130						
	5	0.2		TLP3350	TLP3250								
	1.2	0.3					TLP3131						
	1.2	0.45		TLP3331*	TLP3231								
	0.22	0.9		TLP3303	TLP3203								
		1		TLP3403*									
	0.08	3								TLP3553			
0.05	2.5						TLP3100						
0.05	4										TLP3543		
40	20	0.1		TLP3342									
	15	0.12		TLP3316*	TLP3216		TLP3116						
	14	0.12	TLP3440*	TLP3340	TLP3240								
	10	0.14		TLP3341	TLP3241								
	3	0.25			TLP3214		TLP3114						
	1.5	0.3		TLP3315*	TLP3215		TLP3115						
	0.13	1					TLP3123						
	0.15	2								TLP221A	TLP241A*		
	0.15	2.5								TLP3554			
0.06	2.5						TLP3102						
0.06	3.5										TLP3544		
50	1.5	0.3	TLP3475*	TLP3375	TLP3275								
60	50	0.1				TLP175A*							
	15	0.12		TLP3351									
	2	0.4					TLP170A TLP171A TLP172A TLP176A	TLP192A TLP197A	TLP202A* TLP206A*				
	2	0.5								TLP222A TLP227A TLP240A*	TLP598AA TLP592A TLP597A	TLP222A-2* TLP227A-2*	
	1.5	0.4	TLP3412*		TLP3212								
	1.1	0.5									TLP225A		
	1.5	0.4		TLP3312									
	0.7	1					TLP3122						
	0.2	1.5											
	0.17	2									TLP3555		
	0.1	2.5										TLP3542	
	0.07	2.3							TLP3103				
	0.07	3										TLP3545	
	0.06	3.3							TLP3107*				
75	2	0.4		TLP3306									
80	25	0.04		TLP3318			TLP3118						
	20	0.1					TLP3111						
	12	0.12	TLP3417*	TLP3317*	TLP3217								
	8	0.2		TLP3319*			TLP3119						
	1.2	0.35					TLP3121						
	0.15	1.25						TLP3120					
100	14	0.08		TLP3320*	TLP3220								
	0.67	1		TLP3420*							TLP3556		
		0.2	1.4						TLP3105				
		0.2	2									TLP3546	

*: New product *: Dual-channel

4 Photorelays (1-Form-A and 2-Form-A) (continued)

Features			Package									
												
Off-State Voltage (max) (V)	On-State Resistance (max) (Ω)	On-State Current (max) (A)	VSON4	USOP4	SSOP4	SO6	2.54SOP4	2.54SOP6	2.54SOP8	DIP4	DIP6	DIP8
200	50	0.05					TLP179D	TLP199D	TLP209D*			
	8	0.2					TLP170D TLP171D TLP176D	TLP197D	TLP200D*			
	8	0.25								TLP240D*		
	8	0.3								TLP222D*		
350	50	0.1					TLP170G			TLP240G*		
	50	0.12								TLP228G		TLP228G-2*
	35	0.11					TLP172G	TLP192G	TLP202G*			
	35	0.12					TLP174G TLP176G	TLP197G	TLP206G*	TLP222G TLP224G TLP227G	TLP592G TLP597G	TLP222G-2* TLP224G-2* TLP227G-2*
400	35	0.12					TLP171GA TLP176GA	TLP197GA	TLP206GA*	TLP227GA TLP240GA*	TLP597GA TLP797GA	TLP227GA-2*
	12	0.15									TLP598GA TLP798GA	
	35	0.12					TLP174GA			TLP224GA		TLP224GA-2*
	4	0.2							TLP3125			
600	35	0.1									TLP797J	
	60	0.09					TLP171J TLP170J			TLP240J*		

*: New product *: Dual-channel

MOSFET-Output Photorelays, 1-Form-A in a VSON4 Package

Part Number	Pin Configuration	Features	Trigger LED Current, I _{FT} Max (mA)	RON		I _{ON} Max (A)	V _{OFF} (V)	BV _s 1 Minute (V _{rms})	Safety Standards (1)					
				Max (Ω)	@I _F (mA)				UL	c-UL	TÜV	VDE	BSI	CQC
TLP3403 *		VSON4 Lower RON high current	3	0.22	5	±1	20	300						
TLP3440 *		VSON4 Ultra-low CR: 5 pF · Ω COFF: 0.45 pF (typ.)	3	14	5	±0.12	40	300						
TLP3475 *		VSON4 COFF: 12 pF (typ.) Short insertion delay	3	1.5	5	±0.3	50	300						
TLP3412 *		VSON4 Low RON 60-V V _{FF}	3	1.5	5	±0.4	60	300						
TLP3417 *		VSON4 Low CR COFF: 5 pF (typ.)	3	12	5	±0.12	80	300						
TLP3420 *		VSON4 100-V V _{OFF}	3	14	10	±0.1	100	300						

Note (1): Please refer to page 48.

*: New product

3 Selection Guide

MOSFET-Output Photorelays, 1-Form-A in a USOP4 Package

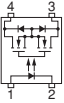
Part Number	Pin Configuration	Features	Trigger LED Current, I _{FT} Max (mA)	R _{ON}		I _{ON} Max (A)	V _{OFF} (V)	BV _s 1 Minute (V _{rms})	Safety Standards ⁽¹⁾						
				Max (Ω)	@I _F (mA)				UL	c-UL	TÜV	VDE	BSI	CQC	
TLP3330 *		USOP4 Ultra-low CR: 5 pF · Ω CoFF: 1 pF (typ.)	4	8	5	±0.16	20	500	○						
TLP3350		USOP4 Ultra-low CR: 2.5 pF · Ω CoFF: 0.8 pF (typ.)	3	5	5	±0.2	20	500	○						
TLP3331 *		USOP4 Ultra-low CR: 5 pF · Ω CoFF: 5 pF (typ.)	4	1.2	5	±0.45	20	500	○						
TLP3303		USOP4 Ultra-low On-resistance R 0.18 Ω (typ.) High output current I _{ON} : 0.9 A (max)	3	0.22	5	±0.9	20	500	○						
TLP3342		USOP4 Ultra-low CoFF: 0.3 pF (typ.)	3	20	5	±0.1	40	500	○						
TLP3316 *		USOP4 Ultra-low CR: 10 pF · Ω CoFF: 1 pF (typ.)	4	15	5	±0.12	40	500	○						
TLP3340		USOP4 Ultra-low CR: 5 pF · Ω CoFF: 0.45 pF (typ.)	3	14	5	±0.12	40	500	○						
TLP3341		USOP4 Ultra-low CR: 5 pF · Ω CoFF: 0.7 pF (typ.)	3	10	5	±0.14	40	500	○						
TLP3315 *		USOP4 Ultra-low CR: 10 pF · Ω CoFF: 10 pF (typ.)	4	1.5	5	±0.3	40	500	○						
TLP3375		USOP4 CoFF: 12 pF (typ.) Short insertion delay	3	1.5	5	±0.3	50	500	○						
TLP3351		USOP4 Ultra-low CoFF: 0.7 pF (typ.)	3	15	5	±0.12	60	500	○						
TLP3312		USOP4 CoFF: 20 pF (Typ.)	3	1.5	5	±0.4	60	500	○						
TLP3306		USOP4 75-V V _{OFF}	3	2	5	±0.4	75	500	○						
TLP3317 *		USOP4 Low CR: 35 pF · Ω CoFF: 5 pF (typ.)	5	12	5	±0.12	80	500	○						
TLP3319 *		USOP4 Low CR: 30 pF · Ω CoFF: 6.5 pF (typ.) 11 pF (max)	3	8	5	±0.2	80	500	○						
TLP3320 *	USOP4 100-V V _{OFF}	5	14	10	±0.1	100	500	○							

Note (1): Please refer to page 48.

*: New product

MOSFET-Output Photorelays, 1-Form-A in a SSOP4 Package

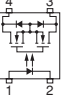
Part Number	Pin Configuration	Features	Trigger LED Current, I _{FT} Max (mA)	R _{ON}		I _{ON} Max (A)	V _{OFF} (V)	BV _s 1 Minute (V _{rms})	Safety Standards ⁽¹⁾						
				Max (Ω)	@ I _F (mA)				UL	c-UL	TÜV	VDE	BSI	CQC	
TLP3230		SSOP4 Ultra-low CR: 5 pF · Ω C _{OFF} : 1 pF (typ.)	4	8	5	±0.16	20	1500	○						
TLP3250		SSOP4 Ultra-low CR: 2.5 pF · Ω C _{OFF} : 0.8 pF (typ.)	3	5	5	±0.2	20	1500	○						
TLP3231		SSOP4 Ultra-low CR: 5 pF · Ω C _{OFF} : 5 pF (typ.)	4	1.2	5	±0.45	20	1500	○						
TLP3203		SSOP4 Ultra-low On-resistance R 0.18 Ω (typ.) High output current I _{ON} : 0.9 A (max)	3	0.22	5	±0.9	20	1500	○						
TLP3216		SSOP4 Ultra-low CR: 10 pF · Ω C _{OFF} : 1 pF (typ.)	4	15	5	±0.12	40	1500	○						
TLP3240		SSOP4 Ultra-low CR: 5 pF · Ω C _{OFF} : 0.45 pF (typ.)	3	14	5	±0.12	40	1500	○						
TLP3241		SSOP4 Ultra-low CR: 5 pF · Ω C _{OFF} : 0.7 pF (typ.)	3	10	5	±0.14	40	1500	○						
TLP3214		SSOP4 Ultra-low CR: 10 pF · Ω C _{OFF} : 5 pF (typ.)	4	3	5	±0.25	40	1500	○						
TLP3215		SSOP4 Ultra-low CR: 10 pF · Ω C _{OFF} : 10 pF (typ.)	4	1.5	5	±0.3	40	1500	○						
TLP3275		SSOP4 C _{OFF} 12 pF (typ.) Short insertion delay	3	1.5	5	±0.3	50	1500	○						
TLP3212		SSOP4 Low CR: 20 pF · Ω C _{OFF} : 20 pF (typ.)	5	1.5	5	±0.4	60	1500	○						
TLP3217		SSOP4 Low CR C _{OFF} : 5 pF (typ.)	5	12	5	±0.12	80	1500	○						
TLP3220		SSOP4 100-V V _{OFF}	5	14	10	±0.08	100	1500	○						

Note (1): Please refer to page 48.

MOSFET-Output Photorelays, 1-Form-A in a SO6 Package

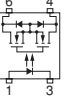
Part Number	Pin Configuration	Features	Trigger LED Current, I _{FT} Max (mA)	R _{ON}		I _{ON} Max (A)	V _{OFF} (V)	BV _s 1 Minute (V _{rms})	Safety Standards ⁽¹⁾					
				Max (Ω)	@ I _F (mA)				UL	c-UL	TÜV	VDE	BSI	CQC
TLP175A		SO6 General-purpose Low trigger current	1	50	2	±0.1	60	3750	○	○		□		○

Note (1): Please refer to page 48.

3 Selection Guide

MOSFET-Output Photorelays, 1-Form-A in a 2.54SOP4 Package

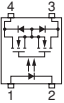
Part Number	Pin Configuration	Features	Trigger LED Current, I _{FT} Max (mA)	R _{ON}		I _{ON} Max (A)	V _{OFF} (V)	BV _s 1 Minute (V _{rms})	Safety Standards ⁽¹⁾					
				Max (Ω)	@I _F (mA)				UL	c-UL	TÜV	VDE	BSI	CQC
TLP3130		2.54SOP4 Lead pitch: 2.54 mm Ultra-low CR: 5 pF · Ω COFF: 1 pF (typ.)	4	8	5	±0.16	20	1500	○	○				
TLP3131		2.54SOP4 Lead pitch: 2.54 mm Ultra-low CR: 4 pF · Ω COFF: 5 pF (typ.)	4	1.2	5	±0.3	20	1500	○	○				
TLP3116		2.54SOP4 Lead pitch: 2.54 mm Ultra-low CR: 10 pF · Ω COFF: 1 pF (typ.)	4	15	5	±0.12	40	1500	○	○		△		
TLP3114		2.54SOP4 Lead pitch: 2.54 mm Ultra-low CR: 10 pF · Ω COFF: 5 pF (typ.)	4	3	5	±0.25	40	1500	○	○		△		
TLP3115		2.54SOP4 Lead pitch: 2.54 mm Ultra-low CR: 10 pF · Ω COFF: 10 pF (typ.)	4	1.5	5	±0.3	40	1500	○	○		△		
TLP3123		2.54SOP4 Lead pitch: 2.54 mm High output current I _{ON} : 1 A (max) @T _a : up to 50°C	3	0.13	5	±1	40	1500	○	○		△		
TLP170A		2.54SOP4 Lead pitch: 2.54 mm Low trigger current General-purpose	1	2	2	±0.4	60	1500	○	○		△		
TLP171A		2.54SOP4 Lead pitch: 2.54 mm Ultra-low trigger current	0.2	2	0.5	±0.4	60	1500	○	○		△		
TLP172A		2.54SOP4 Lead pitch: 2.54 mm High output current General-purpose	3	2	5	±0.4	60	1500	○	○		△		
TLP176A		2.54SOP4 Lead pitch: 2.54 mm High output current	3	2	5	±0.4	60	1500	○	○	△	○		
TLP3122		2.54SOP4 Lead pitch: 2.54 mm High output current I _{ON} : 1 A (max) @T _a : up to 50°C	3	0.7	5	±1	60	1500	○	○		△		
TLP3118		2.54SOP4 Lead pitch: 2.54 mm Low CR: 40 pF · Ω COFF: 2.5 pF (typ.) 3.5 pF (max)	3	25	5	±0.04	80	1500	○	○		△		
TLP3111		2.54SOP4 Lead pitch: 2.54 mm Low CR COFF: 11 pF (typ.)	4	20	5	±0.1	80	1500	○					
TLP3119		2.54SOP4 Lead pitch: 2.54 mm Low CR: 30 pF · Ω COFF: 6.5 pF (typ.) 11 pF (max)	3	8	5	±0.2	80	1500	○	○		△		
TLP3121		2.54SOP4 Lead pitch: 2.54 mm Low CR: 30 pF · Ω	4	1.2	5	±0.35	80	1500	○	○		△		
TLP179D		2.54SOP4 Lead pitch: 2.54 mm COFF 15 pF (typ.)	3	50	5	±0.05	200	1500	○	○				
TLP170D		2.54SOP4 Lead pitch: 2.54 mm Low trigger current General-purpose	1	8	2	±0.2	200	1500	○	○		△		

Note (1): Please refer to page 48.

MOSFET-Output Photorelays, 1-Form-A in a 2.54SOP4 Package (Continued)

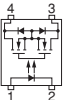
Part Number	Pin Configuration	Features	Trigger LED Current, I _{FT} Max (mA)	R _{ON}		I _{ON} Max (A)	V _{OFF} (V)	BVs 1 Minute (V _{rms})	Safety Standards ⁽¹⁾					
				Max (Ω)	@I _F (mA)				UL	c-UL	TÜV	VDE	BSI	CQC
TLP171D		2.54SOP4 Lead pitch: 2.54 mm Ultra-low trigger current	0.2	8	0.5	±0.2	200	1500	○	○		△		
TLP176D		2.54SOP4 Lead pitch: 2.54 mm Low On-resistance	3	8	5	±0.2	200	1500	○	○	△	○		
TLP170G		2.54SOP4 Lead pitch: 2.54 mm Low trigger current General-purpose	1	50	2	±0.1	350	1500	○	○		△		
TLP172G		2.54SOP4 Lead pitch: 2.54 mm General-purpose	3	50	5	±0.11	350	1500	○	○		△		
TLP174G		2.54SOP4 Lead pitch: 2.54 mm Current-limiting function Limit current: 150 to 300 mA	3	35	5	±0.12	350	1500	○	○				
TLP176G		2.54SOP4 Lead pitch: 2.54 mm General-purpose SEMKO-approved	3	35	5	±0.12	350	1500	○	○	△	○	○	
TLP171GA		2.54SOP4 Lead pitch: 2.54 mm Ultra-low trigger current	0.2	35	0.5	±0.1	400	1500	○	○		△		
TLP176GA		2.54SOP4 Lead pitch: 2.54 mm General-purpose	3	35	5	±0.12	400	1500	○			△	○	
TLP174GA		2.54SOP4 Lead pitch: 2.54 mm Current-limiting function Limit current: 150 to 300 mA	3	35	5	±0.12	400	1500	○					
TLP171J		2.54SOP4 Lead pitch: 2.54 mm Ultra-low trigger current	0.2	60	0.5	±0.07	600	1500	○	○		△		
TLP170J		2.54SOP4 Lead pitch: 2.54 mm Low trigger current General-purpose	1	60	2	±0.09	600	1500	○	○		△		

Note (1): Please refer to page 48.

3 Selection Guide

MOSFET-Output Photorelays, 1-Form-A in a 2.54SOP6 Package

Part Number	Pin Configuration	Features	Trigger LED Current, I _{FT} Max (mA)	R _{ON}		I _{ON} Max (A)	V _{OFF} (V)	BV _s 1 Minute (V _{rms})	Safety Standards ⁽¹⁾						
				Max (Ω)	@I _F (mA)				UL	c-UL	TÜV	VDE	BSI	CQC	
TLP3100		2.54SOP6 Lead pitch: 2.54 mm Low On-resistance High output current: I _{ON} = 2.5 A (max) @Ta: up to 50° C	3	0.05	5	±2.5	20	1500	○	○					
TLP3102		2.54SOP6 General-purpose High output current: I _{ON} = 2.5 A (max) @Ta: up to 50°C C-connection: I _{ON} (DC) = 5.0 A (max)	3	0.06	5	±2.5	40	1500	○	○					
TLP192A		2.54SOP6 Lead pitch: 2.54 mm High output current	3	2	5	±0.4	60	1500	○	○					
TLP197A		2.54SOP6 Lead pitch: 2.54 mm High output current	3	2	5	±0.4	60	1500	○	○					
TLP3103		2.54SOP6 General-purpose High output current: I _{ON} = 2.3 A (max) @Ta: up to 50°C C-connection: I _{ON} (DC) = 4.6 A (max)	3	0.07	5	±2.3	60	1500	○	○					
TLP3107 *		2.54SOP6 General-purpose High output current: I _{ON} = 3.3 A (max) C-connection: I _{ON} (DC) = 6.6 A	3	0.06	5	±3.3	60	1500	○	○					
TLP3120		2.54SOP6 Lead pitch: 2.54 mm High output current I _{ON} : 1.25 A (max)	5	0.15	5	±1.25	80	1500	○	○					
TLP3105		2.54SOP6 General-purpose High output current: I _{ON} = 1.4 A (max) @Ta: up to 50°C C-connection: I _{ON} (DC) = 2.8 A (max)	3	0.2	5	±1.4	100	1500	○	○					
TLP199D		2.54SOP6 Lead pitch: 2.54 mm C _{OFF} 15 pF (typ.)	3	50	5	±0.05	200	1500	○	○					
TLP197D		2.54SOP6 Lead pitch: 2.54 mm Low On-resistance	3	8	5	±0.2	200	1500	○	○					
TLP192G		2.54SOP6 Lead pitch: 2.54 mm	3	50	5	±0.11	350	1500	○	○					
TLP197G		2.54SOP6 Lead pitch: 2.54 mm SEMKO-approved	3	35	5	±0.12	350	1500	○	○	△	○	○		
TLP197GA		2.54SOP6 Lead pitch: 2.54 mm	3	35	5	±0.12	400	1500	○					○	

Note (1): Please refer to page 48.

*: New product

MOSFET-Output Photorelays, 2-Form-A and 1-Form-A in a 2.54SOP8 Package

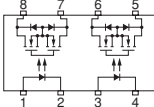
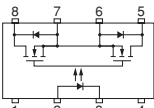
Part Number	Pin Configuration	Features	Trigger LED Current, I _{FT} Max (mA)	R _{ON}		I _{ON} Max (A)	V _{OFF} (V)	BV _s 1 Minute (V _{rms})	Safety Standards ⁽¹⁾							
				Max (Ω)	@ I _F (mA)				UL	c-UL	TÜV	VDE	BSI	CQC		
TLP202A		2.54SOP8 Lead pitch: 2.54 mm Dual channel version of the TLP172A	3	2	5	±0.4	60	1500	○							
TLP206A		2.54SOP8 Lead pitch: 2.54 mm Dual channel version of the TLP176A	3	2	5	±0.4	60	1500	○							
TLP209D		2.54SOP8 Lead pitch: 2.54 mm Dual channel version of the TLP179D	3	50	5	±0.05	200	1500	○							
TLP200D		2.54SOP8 Lead pitch: 2.54 mm Dual channel version of the TLP176D	3	8	5	±0.2	200	1500	○							
TLP202G		2.54SOP8 Lead pitch: 2.54 mm Dual channel version of the TLP172G	3	50	5	±0.11	350	1500	○				△			
TLP206G		2.54SOP8 Lead pitch: 2.54 mm Dual channel version of the TLP176G	3	35	5	±0.12	350	1500	○			△	○	○		
TLP206GA		2.54SOP8 Lead pitch: 2.54 mm Dual channel version of the TLP176GA	3	35	5	±0.12	400	1500	○				△	○	△	
TLP3125			2.54SOP8 Lead pitch: 2.54 mm Low On-resistance	3	4	5	±0.2	400	1500	○	○					

Note (1): Please refer to page 48.

3 Selection Guide

MOSFET-Output Photorelays, 1-Form-A in a DIP4 Package

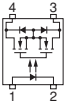
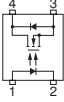
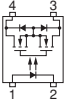
Part Number	Pin Configuration	Features	Trigger LED Current, I _{FT} Max (mA)	R _{ON}		I _{ON} Max (A)	V _{OFF} (V)	BV _s 1 Minute (V _{rms})	Safety Standards ⁽¹⁾					
				Max (Ω)	@I _F (mA)				UL	c-UL	TÜV	VDE	BSI	CQC
TLP3553		DIP4 High output current: I _{ON} = 3 A (max) @Ta = 25°C	3	0.08	5	±3	20	2500	○	○				
TLP221A TLP221AF		DIP4 General-purpose Reinforced insulation ⁽⁵⁾	2	0.15	5	±2.0	40	5000	○	○		○	○	△
TLP241A * TLP241AF *		DIP4 General-purpose Reinforced insulation	3	0.2	5	±2.0	40	5000	○	○		○	△	△
TLP3554		DIP4 High output current: I _{ON} = 2.5 A (max) @Ta = 25°C	3	0.15	5	±2.5	40	2500	○	○				
TLP222A		DIP4 High output current General-purpose	3	2	5	±0.5	60	2500	○	○				
TLP227A		DIP4 General-purpose SEMKO-approved	3	2	5	±0.5	60	2500	○	○				
TLP240A * TLP240AF *		DIP4 General-purpose Reinforced insulation	3	2	5	±0.5	60	5000	○	○		○	△	△
TLP225A		DIP4 For DC use only	5	1.1	10	0.5	60	2500	○	○				
TLP3555		DIP4 High output current: I _{ON} = 2 A (max) @Ta = 25°C	3	0.20	5	±2	60	2500	○	○				
TLP3556		DIP4 High output current: I _{ON} = 1 A (max) @Ta = 25°C	3	0.70	5	±1	100	2500	○	○				
TLP222D *		DIP4 High output current General-purpose	3	8	5	±0.3	200	2500	○	○				
TLP240D * TLP240DF *		DIP4 General-purpose Reinforced insulation	3	8	5	±0.25	200	5000	○	○		○	△	△
TLP240G * TLP240GF *		DIP4 General-purpose Reinforced insulation	3	50	5	±0.1	350	5000	○	○		○	△	△
TLP228G		DIP4 General-purpose SEMKO-approved High EMI immunity	3	50	5	±0.12	350	2500	○	○		○		

Note (1): Please refer to page 48.

*: New product

MOSFET-Output Photorelays, 1-Form-A in a DIP4 Package (Continued)

Part Number	Pin Configuration	Features	Trigger LED Current, I _{FT} Max (mA)	R _{ON}		I _{ON} Max (A)	V _{OFF} (V)	BVs 1 Minute (V _{rms})	Safety Standards (1)						
				Max (Ω)	@ I _F (mA)				UL	c-UL	TÜV	VDE	BSI	CQC	
TLP222G		DIP4 General-purpose SEMKO-approved	3	50	5	±0.12	350	2500	○	○			○		
TLP224G		DIP4 Current-limiting function Limit current: 150 to 300 mA SEMKO-approved	3	35	5	±0.12	350	2500	○	○				○	
TLP227G		DIP4 General-purpose SEMKO-approved	3	35	5	±0.12	350	2500	○	○	△	○	○		
TLP227GA		DIP4 General-purpose SEMKO-approved	3	35	5	±0.12	400	2500	○						
TLP240GA *		TLP240GAF *	DIP4 General-purpose Reinforced insulation	3	35	5	±0.12	400	5000	○	○		○	△	△
TLP224GA		DIP4 For modems Current-limiting function Limit current: 150 to 300 mA	3	35	5	±0.12	400	2500							
TLP240J *		TLP240JF *	DIP4 General-purpose Reinforced insulation	3	60	5	±0.09	600	5000	○	○		○	△	△

Note (1): Please refer to page 48.

*: New product

3 Selection Guide

MOSFET-Output Photorelays, 1-Form-A in a DIP6 Package

Part Number	Pin Configuration	Features	Trigger LED Current, I _{FT} Max (mA)	R _{ON}		I _{ON} Max (A)	V _{OFF} (V)	BV _s 1 Minute (V _{rms})	Safety Standards ⁽¹⁾					
				Max (Ω)	@I _F (mA)				UL	c-UL	TÜV	VDE	BSI	CQC
TLP3543		DIP6 High output current: I _{ON} = 4 A (max) @T _a = 25°C	3	0.05	5	±4	20	2500	○	○				
TLP3544		DIP6 High output current: I _{ON} = 3.5 A (max) @T _a = 25°C	3	0.06	5	±3.5	40	2500	○	○				
TLP598AA		DIP6 High output current	3	2	5	±0.5	60	2500	○					
TLP592A		DIP6 High output current	3	2	5	±0.5	60	2500	○					
TLP597A		DIP6 High output current SEMKO-approved	3	2	5	±0.5	60	2500	○					
TLP3542		DIP6 Low On-resistance High output current: I _{ON} = 2.5 A (max)	3	0.1	10	±2.5	60	2500	○	○				
TLP3545		DIP6 High output current: I _{ON} = 3 A (max) @T _a = 25°C	3	0.07	5	±3	60	2500	○	○				
TLP3546		DIP6 High output current: I _{ON} = 2 A (max) @T _a = 25°C	3	0.2	5	±2	100	2500	○	○				
TLP592G		DIP6 General-purpose	3	50	5	±0.12	350	2500	○					
TLP597G		DIP6 General-purpose SEMKO-approved	3	35	5	±0.12	350	2500	○		○	○	◎	
TLP597GA		DIP6 General-purpose SEMKO-approved	3	35	5	±0.12	400	2500	○					
TLP797GA TLP797GAF		DIP6 High isolation voltage	3	35	5	±0.12	400	5000	○	○	△	○	△	
TLP598GA		DIP6 Low On-resistance	3	12	5	±0.15	400	2500	○					
TLP798GA		DIP6 Low On-resistance	3	12	5	±0.15	400	5000	○	○		△	△	
TLP797J TLP797JF		DIP6 High isolation voltage	5	45	10	±0.1	600	5000	○	○	△	○	△	

Note (1): Please refer to page 48.







MOSFET-Output Photorelays, 2-Form-A in a DIP8 Package

Part Number	Pin Configuration	Features	Trigger LED Current, I_{FT} Max (mA)	R_{ON}		I_{ON} Max (A)	V_{OFF} (V)	BVs 1 Minute (Vrms)	Safety Standards ⁽¹⁾					
				Max (Ω)	@ I_F (mA)				UL	c-UL	TÜV	VDE	BSI	CQC
TLP222A-2		DIP8 Dual channel version of the TLP222A	3	2	5	± 0.5	60	2500	○	○				
TLP227A-2		DIP8 Dual channel version of the TLP227A SEMKO-approved	3	2	5	± 0.5	60	2500	○	○				
TLP228G-2		DIP8 Dual channel version of the TLP228G SEMKO-approved High EMI immunity	3	50	5	± 0.12	350	2500	○	○			○	
TLP222G-2		DIP8 Dual channel version of the TLP222G SEMKO-approved	3	50	5	± 0.12	350	2500	○	○			○	
TLP224G-2		DIP8 Dual channel version of the TLP224G SEMKO-approved	3	35	5	± 0.12	350	2500	○	○			○	
TLP227G-2		DIP8 Dual channel version of the TLP227G SEMKO-approved	3	35	5	± 0.12	350	2500	○	○	△	○	○	
TLP227GA-2		DIP8 Dual channel version of the TLP227GA SEMKO-approved	3	35	5	± 0.12	400	2500	○					
TLP224GA-2		DIP8 Dual channel version of the TLP224GA Current-limiting function Limit current: 150 to 300 mA	3	35	5	± 0.12	400	2500						

Note (1): Please refer to page 48.

3 Selection Guide

5 Photorelays (1-Form-B, 2-Form-B and 1-Form-A/1-Form-B)

Features		Package							
									
	Off-State Voltage (max) (V)	On-State Resistance (max) (Ω)	On-State Current (max) (A)	2.54SOP4	2.54SOP6	2.54SOP8	DIP4	DIP6	DIP8
1-Form-B, 2-Form-B	350	25	0.12	TLP4176G	TLP4197G	TLP4206G*			
		25	0.15				TLP4227G	TLP4597G	TLP4227G-2*
1-Form-A/ 1-Form-B	350	25	0.12			TLP4026G*			TLP4006G*

*: Dual-channel

MOSFET-Output Photorelays, 1-Form-B

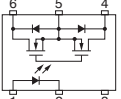
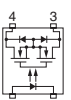
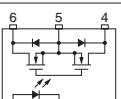
Part Number	Pin Configuration	Features	Trigger LED Current, I_{FT} Max (mA)	R_{ON}		I_{ON} Max (A)	V_{OFF} (V)	BVs 1 Minute (V_{rms})	Safety Standards (1)						
				Max (Ω)	@ I_F (mA)				UL	c-UL	TÜV	VDE	BSI	CQC	
TLP4176G		2.54SOP4 Lead pitch: 2.54 mm General-purpose 1-Form-B	3	25	0	± 0.12	350	1500	○						
TLP4197G		2.54SOP6 Lead pitch: 2.54 mm General-purpose 1-Form-B	3	25	0	± 0.12	350	1500	○						
TLP4227G		DIP4 General-purpose 1-Form-B SEMKO-approved	3	25	0	± 0.15	350	2500	○						
TLP4597G		DIP6 General-purpose 1-Form-B SEMKO-approved	3	25	0	± 0.15	350	2500	○						

Note (1): Please refer to page 48.

MOSFET-Output Photorelays, 2-Form-B

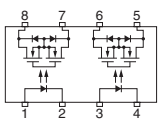
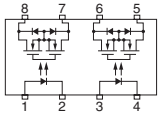
Part Number	Pin Configuration	Features	Trigger LED Current, I _{FT} Max (mA)	R _{ON}		I _{ON} Max (A)	V _{OFF} (V)	BV _s 1 Minute (V _{rms})	Safety Standards ⁽¹⁾						
				Max (Ω)	@ I _F (mA)				UL	c-UL	TÜV	VDE	BSI	CQC	
TLP4206G		2.54SOP8 Lead pitch: 2.54 mm Dual channel version of the TLP4176G 2-Form-B	3	25	0	±0.12	350	1500	○						
TLP4227G-2		DIP8 Dual channel version of the TLP4227G SEMKO-approved 2-Form-B	3	25	0	±0.15	350	2500	○						

Note (1): Please refer to page 48.

MOSFET-Output Photorelays, 1-Form-A/1-Form-B

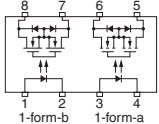
Part Number	Pin Configuration	Features	Trigger LED Current, I _{FT} Max (mA)	R _{ON}		I _{ON} Max (A)	V _{OFF} (V)	BV _s 1 Minute (V _{rms})	Safety Standards ⁽¹⁾						
				Max (Ω)	@ I _F (mA)				UL	c-UL	TÜV	VDE	BSI	CQC	
TLP4026G		2.54SOP8 Lead pitch: 2.54 mm General-purpose 1-Form-A/1-Form-B	3	25	1-Form-A 5 1-Form-B 0	±0.12	350	1500	○						
TLP4006G		DIP8 General-purpose 1-Form-A/1-Form-B	3	25	1-Form-A 5 1-Form-B 0	±0.12	350	2500							

Note (1): Please refer to page 48.

3 Selection Guide

6 Triac-Output Photocouplers

Package									
		MFSOP6		SO6		DIP4		DIP6	
Features	Isolation voltage	NZC	ZC	NZC	ZC	NZC	ZC	NZC	ZC
		400 V	2500 Vrms	TLP160G	TLP161G			TLP525G	
	5000 Vrms							TLP3022(S) TLP3023(S)	TLP3042(S) TLP3043(S)
600 V	2500 Vrms	TLP160J TLP165J	TLP161J TLP163J TLP166J TLP168J					TLP560J	TLP561J
	3750 Vrms			TLP265J* TLP267J*	TLP266J* TLP268J*				
	4000 Vrms							TLP762J	TLP763J
	5000 Vrms					TLP360J	TLP361J TLP363J	TLP3052(S)	TLP3062(S) TLP3063(S) TLP3064(S) TLP3762(S)
800 V	5000 Vrms							TLP3082(S) TLP3782(S) TLP3783(S)	

NZC: Non-zero cross
ZC: Zero cross

*: New product

Triac-Output Photocouplers for Solid State Relays (SSRs)

Part Number	Pin Configuration	Features	Trigger LED Current, I _{FT}		Peak On-State Voltage, V _{TM}		Off-State Output Terminal Voltage V _{DRM} (V)	BVs 1 Minute (Vrms)	Safety Standards ⁽¹⁾					
			Rank	Max (mA)	Max (V)	@I _{TM} (mA)			UL	c-UL	TÜV	VDE	BSI	CQC
TLP160G		Mini-flat MFSOP6 Non-zero cross	—	10	2.8	70	400	2500	○	○	△	○		
IFT7			7											
IFT5			5											
TLP165J TLP160J		Mini-flat MFSOP6 Zero cross	—	10	2.8	70	600	2500	○	○	△	○		
IFT7			7											
IFT5			5											
TLP161G		Mini-flat MFSOP6 Zero cross	—	10	2.8	70	400	2500	○	○	△	○		
IFT7			7											
IFT5			5											
IFT7			7											
TLP166J TLP161J		Mini-flat MFSOP6 Zero cross High impulse noise immunity V _N = 2000 V (typ.)	—	10	2.8	100	600	2500	○	○	△	△		
IFT7			7											
IFT5			5											
IFT7			7											
TLP163J		Mini-flat MFSOP6 Zero cross	—	10	2.8	70	600	2500	○	○	△	○		
IFT7			7											
TLP168J		Mini-flat MFSOP6 Zero cross	—	3	2.8	70	600	2500	○	○	○			
IFT7			7											
TLP265J *		SO6 (reinforced insulation) Non-zero cross	—	10	2.8	70	600	3750	○	○	△	□		○
IFT7			7											

Note (1): Please refer to page 48.

*: New product

Triac-Output Photocouplers for Solid State Relays (SSRs) (Continued)

Part Number	Pin Configuration	Features	Trigger LED Current, I_{FT}		Peak On-State Voltage, V_{TM}		Off-State Output Terminal Voltage V_{DRM} (V)	BVs 1 Minute (V_{rms})	Safety Standards ⁽¹⁾					
			Rank	Max (mA)	Max (V)	@ I_{TM} (mA)			UL	c-UL	TÜV	VDE	BSI	CQC
TLP266J *		SO6 (reinforced insulation) Zero cross	—	10	2.8	70	600	3750	○	○	△	□		○
			IFT7	7										
TLP267J *		SO6 (reinforced insulation) Non-zero cross Low trigger LED current	—	3	2.8	70	600	3750	○	○		□		○
			IFT2	2										
TLP268J *		SO6 (reinforced insulation) Zero cross Low trigger LED current	—	3	2.8	70	600	3750	○	○		□		○
			IFT2	2										

Note (1): Please refer to page 48.

*: New product

Triac-Output Photocouplers for Office Equipment

Part Number	Pin Configuration	Features	Trigger LED Current, I_{FT}		Peak On-State Voltage, V_{TM}		Off-State Output Terminal Voltage V_{DRM} (V)	BVs 1 Minute (V_{rms})	Safety Standards ⁽¹⁾					
			Rank	Max (mA)	Max (V)	@ I_{TM} (mA)			UL	c-UL	TÜV	VDE	BSI	CQC
TLP360J TLP360JF		DIP4 Non-zero cross	—	10	3.0	100	600	5000	○	○	○	○		△
			IFT7	7										
TLP361J TLP361JF		DIP4 Zero cross	—	10	3.0	100	600	5000	○	○	○	○		△
			IFT7	7										
TLP363J TLP363JF		DIP4 Zero cross High impulse noise immunity $V_N = 2000$ V (typ.)	—	10										△

Note (1): Please refer to page 48.

3 Selection Guide

Triac-Output Photocouplers for AC 100 to 120 V Lines

Part Number	Pin Configuration	Features	Trigger LED Current, I_{FT}		Peak On-State Voltage, V_{TM}		Off-State Output Terminal Voltage V_{DRM} (V)	BVs 1 Minute (V_{rms})	Safety Standards ⁽¹⁾					
			Rank	Max (mA)	Max (V)	@ I_{TM} (mA)			UL	c-UL	TÜV	VDE	BSI	CQC
TLP525G		DIP4 Non-zero cross	—	10	3.0	100	400	2500	○	○				
TLP560G		DIP6 General-purpose Non zero cross	—	10	3.0	100	400	2500	○	○		○		
			IFT7	7										
			IFT5	5										
TLP561G		DIP6 General-purpose Zero cross	—	10	3.0	100	400	2500	○	○		○		
			IFT7	7										
			IFT5	5										
TLP3022(S) TLP3022F(S)		DIP6 SEMKO-approved Non-zero cross	—	10	3.0	100	400	5000	○	○	△	○	◎	
TLP3023(S) TLP3023F(S)		DIP6 SEMKO-approved Non-zero cross	—	5										
TLP3042(S) TLP3042F(S)		DIP6 SEMKO-approved Zero cross	—	10	3.0	100	400	5000	○	○	△	○	◎	
TLP3043(S) TLP3043F(S)		DIP6 SEMKO-approved Zero cross	—	5										

Note (1): Please refer to page 48.



Triac-Output Photocouplers for AC 200 to 240 V Line

Part Number	Pin Configuration	Features	Trigger LED Current, I _{FT}		Peak On-State Voltage, V _{TM}		Off-State Output Terminal Voltage V _{DRM} (V)	BVs 1 Minute (V _{rms})	Safety Standards ⁽¹⁾					
			Rank	Max (mA)	Max (V)	@I _{TM} (mA)			UL	c-UL	TÜV	VDE	BSI	CQC
TLP560J		DIP6 General-purpose Non zero cross	—	10	3.0	100	600	2500	○	○		○		
			IFT7	7										
TLP561J		DIP6 General-purpose Zero cross	—	10	3.0	100	600	2500	○	○		○		
			IFT7	7										
TLP762J TLP762JF		DIP6 SEMKO-approved Non zero cross	—	10	3.0	100	600	4000	○	○	△	○	◎	
TLP763J TLP763JF		DIP6 SEMKO-approved Zero cross	—	10	3.0	100	600	4000	○	○	△	○	◎	
TLP3052(S) TLP3052F(S)		DIP6 High V _{DRM} SEMKO-approved Non-zero cross	—	10	3.0	100	600	5000	○	○	△	○	◎	○
TLP3062(S) TLP3062F(S)		DIP6 SEMKO-approved High V _{DRM} Zero cross	—	10	3.0	100	600	5000	○	○	△	○	◎	○
TLP3063(S) TLP3063F(S)			—	5	3.0	100	600	5000	○	○	△	○	◎	○
TLP3064(S) TLP3064F(S)		DIP6 SEMKO-approved Zero cross	—	3	3.0	100	600	5000	○	○	△	○	◎	
TLP3082(S) TLP3082F(S)		DIP6 Zero cross	—	10	3.0	100	800	5000	○	○	△	○	◎	
TLP3762(S) TLP3762F(S)		DIP6 Zero cross High impulse noise immunity V _N = 2000 V (typ.)	—	10	3.0	100	600	5000	○	○	△	○	◎	
TLP3782(S) TLP3782F(S)		DIP6 High impulse noise immunity V _N = 1500 V (typ.)	—	10	3.0	100	800	5000	○	○	△	○		
TLP3783(S) TLP3783F(S)			—	5	3.0	100	800	5000	○	○	△	○		

Note (1): Please refer to page 48.

3 Selection Guide

7 Thyristor-Output Photocouplers

Package				
		Features		
V _{DRM}	Isolation voltage	MFSOP6	DIP6	DIP8
400 V	2500 Vrms	TLP148G		
600 V	2500 Vrms		TLP548J	TLP549J
	4000 Vrms		TLP748J	

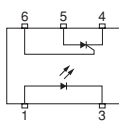
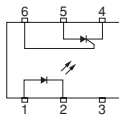
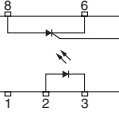
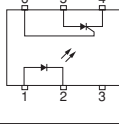

Part Number	Pin Configuration	Features	Trigger LED Current, I _{FT}	Peak On-State Voltage, V _{TM}		Off-State Output Terminal Voltage V _{DRM} (V)	BV _s 1 Minute (Vrms)	Safety Standards ⁽¹⁾						
			Max (mA)	Max (V)	@I _{TM} (mA)			UL	c-UL	TÜV	VDE	BSI	CQC	
TLP148G		Mini-flat MFSOP6 General-purpose	10	1.45	100	400	2500	○	○					
TLP548J		DIP6 General-purpose Low trigger current	7	1.45	100	600	2500	○	△					
TLP549J		DIP8 Long anode-cathode distance (SCR)	7	1.45	100	600	2500	○	△					
TLP748J TLP748JF		DIP6 SEMKO-approved	10	1.45	100	600	4000	○	○	△	○	◎		

Note (1): Please refer to page 48.

Reference

Note (1): Certified to safety standards. For details on certification status, contact your Toshiba sales representative.
 UL/c-UL/IEC/CQC: ○: Approved △: Approval pending as of August 2014
 BSI and IEC: ○: Approved (supplementary or basic insulation) ◎: Approved (reinforced insulation) △: Design which meets safety standard/ approval pending as of August 2014 BSI: EN 60065 / EN 60950-1, IEC: IEC 60065 / IEC 60950-1
 TÜV and VDE: ○: Approved □: Approved with option of EN 60950-1 / EN 60065
 △: Design which meets safety standard/approval pending as of August 2014
 EN 60747-5-5-approved with option V4 or D4
 UL: Underwriters Laboratories (UL) is a safety consulting and certification company.
 c-UL: c-UL Mark is the UL Mark for Canada.
 TÜV: Technischer Überwachungsverein
 VDE: VERBAND DEUTSCHER ELECTROTECHNISCHER e.V.
 BSI: British Standards Institution
 IEC: International Electrotechnical Commission
 CQC: China Quality Certification center
 (2): The products with the ranks Y and BL are limited in production. For details, please contact your local Toshiba sales representative.
 (3): For details of the devices, please contact your local Toshiba sales representative.

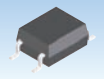
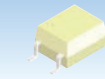
8 Photovoltaic-Output photocouplers

Features		Package				
Short-Circuit Current	Open Voltage		SSOP4	SO6	MFSOP6	DIP6
			1500 Vrms	3750 Vrms	2500 Vrms	
4 μ A	30 V		TLP3924			
5 μ A	7 V		TLP3904		TLP3902	
12 μ A	7 V			TLP3905* TLP3906**	TLP190B	TLP590B
20 μ A	7 V		TLP3914			
24 μ A	7 V				TLP191B**	TLP591B**

†: Built-in Discharging Circuit

*: New product

** : Built-in shunt resistor

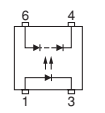
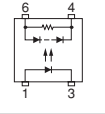
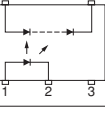
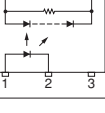
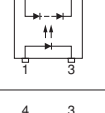
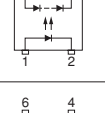
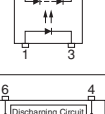
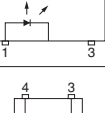
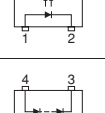
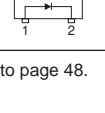
Part Number	Pin Configuration	Features	Short-Circuit Current (μ A)			Open Voltage Voc (V)		BVs 1 Minute (Vrms)	Safety Standards ⁽¹⁾						
			Rank	Min	@I _F (mA)	Min	@I _F (mA)		UL	c-UL	TÜV	VDE	BSI	CQC	
TLP190B		Mini-flat MFSOP6	—	12	10	7	10	2500	○	○					
TLP191B		Mini-flat MFSOP6 Built-in shunt resistor	—	24	20	7	20	2500	○	○					
TLP590B		DIP6 General-purpose	—	12	10	7	10	2500	○						
TLP591B		DIP6 Built-in shunt resistor	—	24	20	7	20	2500	○						
TLP3902		Mini-flat MFSOP6 General-purpose	—	5	10	7	10	2500	○	○					
TLP3904		SSOP4 General-purpose	—	5	10	7	10	1500	○						
TLP3905 *		SO6 General-purpose Topr (max) 125°C	—	12	10	7	10	3750	○	○		□			
TLP3906 *		SO6 General-purpose Topr (max) 125°C Built-in Discharging Circuit	—	12	10	7	10	3750	○	○		□			
TLP3914		SSOP4 High output	—	20	10	7	10	1500	○						
TLP3924		SSOP4 High open-circuit voltage	—	4	10	30	10	1500	○						

Note (1): Please refer to page 48.

*: New product

4 Part Naming Conventions

1. Transistor-Output, Darlington-Transistor-Output and IC-Output Photocouplers

TLP [] [] **F** ([] [] [] [] [] [] [])

Part number

Lead forming with long clearance distance
Null: No lead forming

Safety standard option

CTR rank
See respective datasheets.

Taping:
For tape specifications, see page 63 to 65.
Lead forming (only for DIP packages):
For standard lead forming, see page 51 to 55.

Country of origin
(O: Japan (T: Thailand (C: China) or null: Japan

[[G]]/RoHS COMPATIBLE*, "F" or "E"

Revision code
The revision code may be added to identify a revision of a device. For details, contact your nearest Toshiba sales representative.

Example 1: **TLP785(D4-GB-TP6,F,C)**
→ **TLP785(D4GB-T6,F,C)**
(Abbreviated due to the limit to the number of characters.)
[D4]: EN60747-5-5 option [GB]: CTR rank
[TP6]: LF6 lead form
Tape-and-reel packing
[,F]: RoHS COMPATIBLE* [C]: Country of origin: China

Example 2: **TLP785F(GR,F,C)**
[F]: Wide-spaced leads
[GR]: CTR rank
[,F]: RoHS COMPATIBLE*
[C]: Country of origin: China

2. Triac-Output and Thyristor-Output Photocouplers

TLP [] [] **F** ([] [] [] [] [] [] [])

Part number

V_{DRM}
G: 400 V J: 600 V L: 800 V

Lead forming with long clearance distance
Null: No lead forming

Safety standard option

IFT rank
No character: No IFT rank specified
IFTx: For example, IFT5 denotes the 5-mA rank.
See individual technical datasheets.

Taping:
For tape specifications, see page 63 to 65.
Lead forming (only for DIP packages):
For standard lead forming, see page 51 to 55.

Country of origin
(O: Japan (T: Thailand) or null: Japan

[[G]]/RoHS COMPATIBLE*, "F" or "E"

Revision code
The revision code may be added to identify a revision of a device. For details, contact your nearest Toshiba sales representative.

Example 3: **TLP665J(D4-IFT7-TP1,S,F)**
→ **TLP665J(D4T7TP1S,F)**
(Abbreviated due to the limit to the number of characters.)
[J]: V_{DRM}: 600 V
[D4]: EN60747-5-5 option
[IFT7]→[T7]: LED trigger current: 7 mA (max)
[TP1]: LF1 lead form
Tape-and-reel packing
[,S]: Revision code
[,F]: RoHS COMPATIBLE*

3. Photorelays

TLP [] [] **F** ([] [] [] [] [] [] [])

Part number

V_{OFF}
A: 60 V D: 200 V G: 350 V
GA: 400 V J: 600 V
Some photorelays do not have a V_{OFF} code in their names. See respective datasheets.

Lead forming with long clearance distance
Null: No lead forming

Safety standard option

Taping:
For tape specifications, see page 63 to 65.
Lead forming (only for DIP packages):
For standard lead forming, see page 51 to 55.

Country of origin
(O: Japan (T: Thailand) or null: Japan

[[G]]/RoHS COMPATIBLE*, "F" or "E"

Revision code
The revision code may be added to identify a revision of a device. For details, contact your nearest Toshiba sales representative.

Example 4: **TLP227A(TP1,F)**
[A]: V_{OFF}: 60 V
[TP1]: LF1 lead form
Tape-and-reel packing
[,F]: RoHS COMPATIBLE*

Example 5: **TLP3123(TP,F)**
[TP]: Tape-and-reel packing
[,F]: RoHS COMPATIBLE*

*: "F" identifies the indication of product Labels with "[[G]]/RoHS COMPATIBLE".

Please contact your TOSHIBA sales representative for details as to environmental matters such as the RoHS compatibility of Product.





The RoHS is the Directive 2002/95/EC of the European Parliament and of the Council of 27 January 2003 on the restriction of the use of certain hazardous substances in electrical and electronic equipment.

Note: The length of part names is limited to 18 characters. Longer names are abbreviated by omitting the "-" character and/or using shorthand symbols. However, be sure to give full part names when you have any inquiries. For details, please contact your nearest Toshiba sales representative.

5 Package Information

1 Lead Form Options for DIP Packages

The **DIP4**, **DIP6**, **DIP8** and **DIP16** packages offer three surface-mount lead form options and a wide-spaced lead form option. The electrical characteristics are identical, regardless of these options.

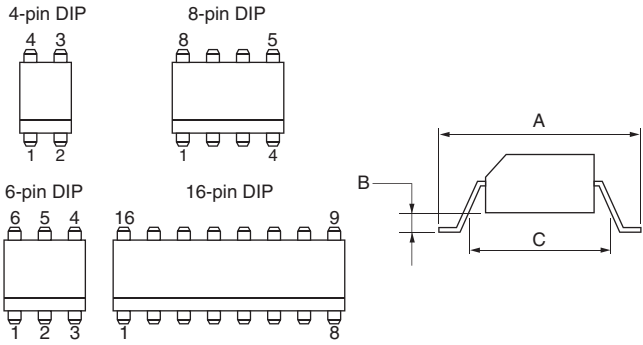
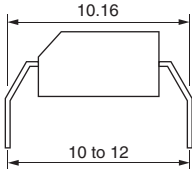
Lead Form	Surface-Mount			Wide-Spaced																																		
Appearance																																						
Lead Form Code	(LF1)	(LF4), (LF7)**	(LF5), (LF6)**	(LF2), TLPxxxF																																		
Carrier Tape Code	(TP1)	(TP4), (TP7)**	(TP5), (TP6)**	Not available*																																		
Package Outlines	 <p>Dimensions Unit: mm</p> <table border="1"> <thead> <tr> <th rowspan="2">Dimension</th> <th colspan="2">(LF1)</th> <th colspan="2">(LF4)</th> <th colspan="2">(LF5)</th> </tr> <tr> <th>Min</th> <th>Max</th> <th>Min</th> <th>Max</th> <th>Min</th> <th>Max</th> </tr> </thead> <tbody> <tr> <td>A</td> <td>–</td> <td>10.0</td> <td>–</td> <td>12.0</td> <td>–</td> <td>10.0</td> </tr> <tr> <td>B</td> <td colspan="2">(0.35 typ.)</td> <td colspan="2">(0.25 typ.)</td> <td>–</td> <td>0.2</td> </tr> <tr> <td>C</td> <td>6.4</td> <td>–</td> <td>8.0</td> <td>–</td> <td>6.4</td> <td>–</td> </tr> </tbody> </table> <p>All other package dimensions are the same as for each standard package specification.</p>			Dimension	(LF1)		(LF4)		(LF5)		Min	Max	Min	Max	Min	Max	A	–	10.0	–	12.0	–	10.0	B	(0.35 typ.)		(0.25 typ.)		–	0.2	C	6.4	–	8.0	–	6.4	–	
Dimension	(LF1)		(LF4)		(LF5)																																	
	Min	Max	Min	Max	Min	Max																																
A	–	10.0	–	12.0	–	10.0																																
B	(0.35 typ.)		(0.25 typ.)		–	0.2																																
C	6.4	–	8.0	–	6.4	–																																

* Tape-and-reel packing is not available with (LF2).

Example 1: Standard part: TLP620(F)

Surface-mount option: TLP620(LF1,F): Packed in stick magazines.

Surface-mount and tape-and-reel options: TLP620(TP1,F): Packed in tape-and-reel.

■ Standard part names should be used when applying for safety standard approval.

** The package dimensions and lead form options of the TLP785 differ from those shown above.

See the TLP785 datasheet.

5 Package Information

*All dimensions are for reference only unless tolerance is given.

2 Package Dimensions (4-Pin DIP)

Standard	DIP4	DIP4 (LF1) / (TP1)	DIP4 (LF2), TLP _{xxx} F	DIP4 (LF4) / (TP4), (LF7) / (TP7)	DIP4 (LF5) / (TP5), (LF6) / (TP6)
<p>Unit: mm</p>	<p>Unit: mm</p>	<p>Unit: mm</p>	<p>Unit: mm</p>	<p>Unit: mm</p>	

*All dimensions are for reference only unless tolerance is given.

2 Package Dimensions (6-Pin DIP)

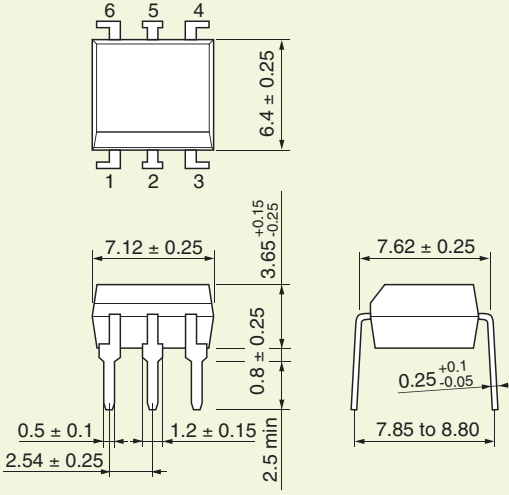
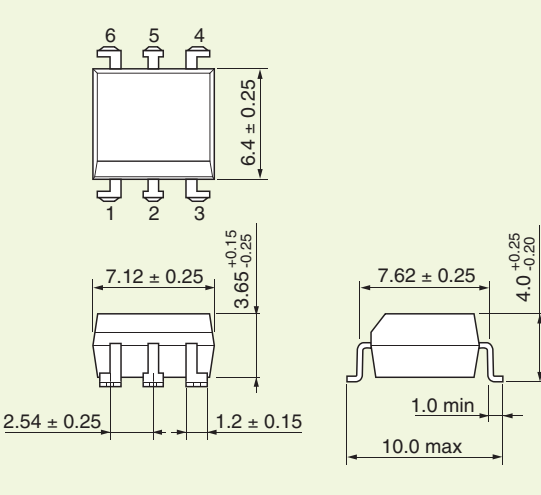
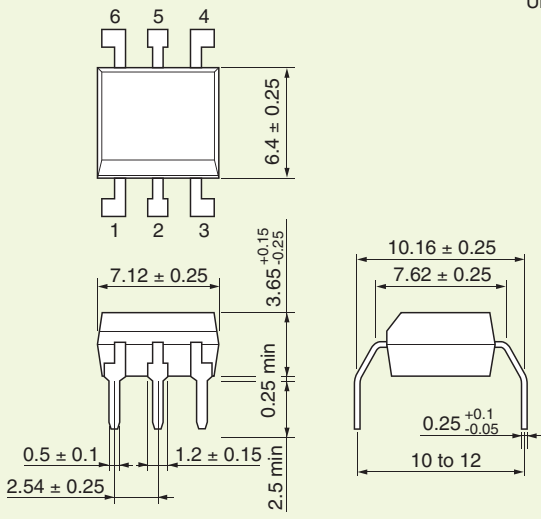
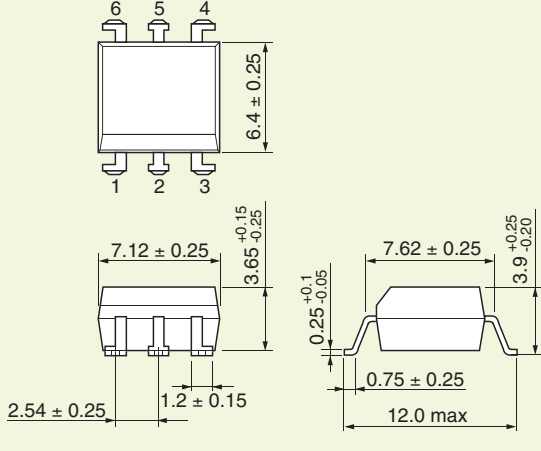
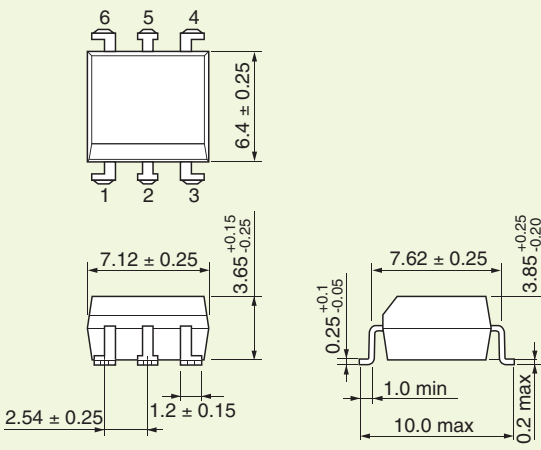
Standard	DIP6 (LF1) / (TP1)
<p>DIP6</p> <p>Unit: mm</p> 	<p>DIP6 (LF1) / (TP1)</p> <p>Unit: mm</p> 
<p>DIP6 (LF2)</p> <p>Unit: mm</p> 	<p>DIP6 (LF4) / (TP4)</p> <p>Unit: mm</p> 
<p>DIP6 (LF5) / (TP5)</p>	
<p>Unit: mm</p> 	

5 Package Information

*All dimensions are for reference only unless tolerance is given.

2 Package Dimensions (8-Pin DIP)

Standard	DIP8 (LF1) / (TP1)
<p style="text-align: right;">Unit: mm</p> <p>Dimensions for Standard DIP8:</p> <ul style="list-style-type: none"> Pin 1 to Pin 4: 9.66 ± 0.25 mm Pin 5 to Pin 8: 9.66 ± 0.25 mm Package height: 6.4 ± 0.25 mm Lead length: 7.62 ± 0.25 mm Lead thickness: 0.25^{+0.1}_{-0.05} mm Lead width: 1.2 ± 0.15 mm Lead spacing: 0.5 ± 0.1 mm Lead height: 2.5 min Lead angle: 0.8 ± 0.25 mm Lead tip radius: 0.25 ± 0.15 mm Lead tip width: 2.54 ± 0.25 mm 	<p style="text-align: right;">Unit: mm</p> <p>Dimensions for DIP8 (LF1) / (TP1):</p> <ul style="list-style-type: none"> Pin 1 to Pin 4: 9.66 ± 0.25 mm Pin 5 to Pin 8: 9.66 ± 0.25 mm Package height: 6.4 ± 0.25 mm Lead length: 7.62 ± 0.25 mm Lead thickness: 0.25^{+0.1}_{-0.05} mm Lead width: 1.2 ± 0.15 mm Lead height: 4.0^{+0.25}_{-0.20} mm Lead angle: 1.0 min Lead tip radius: 10.0 max Lead tip width: 2.54 ± 0.25 mm
<p style="text-align: right;">Unit: mm</p> <p>Dimensions for DIP8 (LF2):</p> <ul style="list-style-type: none"> Pin 1 to Pin 4: 9.66 ± 0.25 mm Pin 5 to Pin 8: 9.66 ± 0.25 mm Package height: 6.4 ± 0.25 mm Lead length: 10.16 ± 0.25 mm Lead thickness: 0.25^{+0.1}_{-0.05} mm Lead width: 1.2 ± 0.15 mm Lead height: 2.5 min Lead angle: 0.25 min Lead tip radius: 10 to 12 mm Lead tip width: 2.54 ± 0.25 mm 	<p style="text-align: right;">Unit: mm</p> <p>Dimensions for DIP8 (LF4) / (TP4):</p> <ul style="list-style-type: none"> Pin 1 to Pin 4: 9.66 ± 0.25 mm Pin 5 to Pin 8: 9.66 ± 0.25 mm Package height: 6.4 ± 0.25 mm Lead length: 7.62 ± 0.25 mm Lead thickness: 0.25^{+0.1}_{-0.05} mm Lead width: 1.2 ± 0.15 mm Lead height: 3.9^{+0.25}_{-0.20} mm Lead angle: 0.75 ± 0.25 mm Lead tip radius: 12.0 max Lead tip width: 2.54 ± 0.25 mm
<p style="text-align: right;">Unit: mm</p> <p>Dimensions for DIP8 (LF5) / (TP5):</p> <ul style="list-style-type: none"> Pin 1 to Pin 4: 9.66 ± 0.25 mm Pin 5 to Pin 8: 9.66 ± 0.25 mm Package height: 6.4 ± 0.25 mm Lead length: 7.62 ± 0.25 mm Lead thickness: 0.25^{+0.1}_{-0.05} mm Lead width: 1.2 ± 0.15 mm Lead height: 3.85^{+0.25}_{-0.20} mm Lead angle: 1.0 min Lead tip radius: 10.0 max Lead tip width: 2.54 ± 0.25 mm 	

*All dimensions are for reference only unless tolerance is given.

2 Package Dimensions (Other DIP Packages)

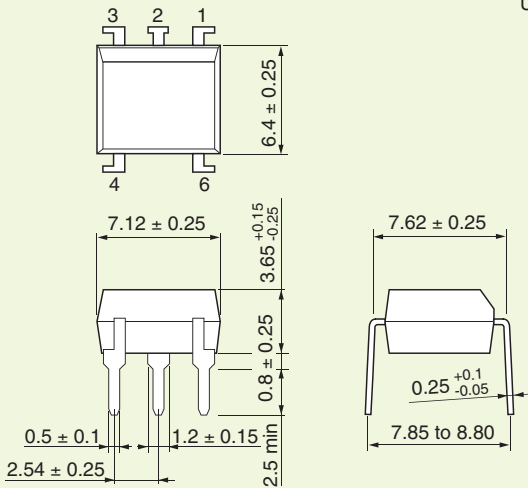
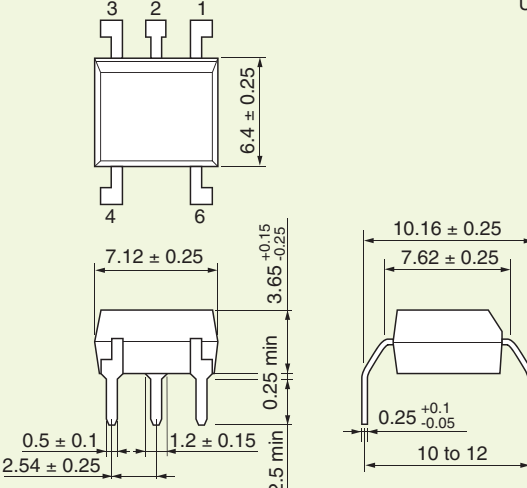
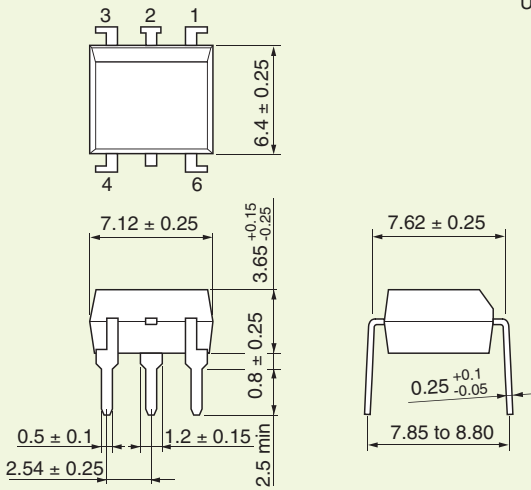
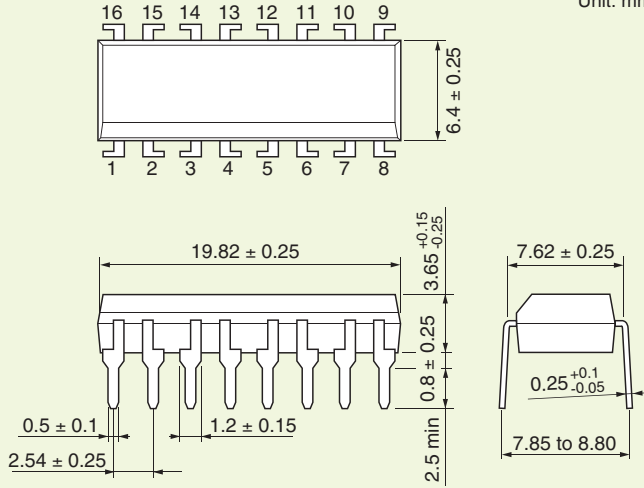
5-pin DIP6	5-pin DIP6 (LF2)
<p>Unit: mm</p>  <p>Top view dimensions: Pin 1 to 3, Pin 4 to 6, width 6.4 ± 0.25, pin pitch 7.12 ± 0.25.</p> <p>Side view dimensions: Pin height $3.65^{+0.15}_{-0.25}$, pin width 0.8 ± 0.25, pin length 2.54 ± 0.25, pin spacing 0.5 ± 0.1, pin offset 1.2 ± 0.15, total length 2.5.</p> <p>Bottom view dimensions: Pin width $0.25^{+0.1}_{-0.05}$, pin length 7.62 ± 0.25, pin spacing 7.85 to 8.80.</p>	<p>Unit: mm</p>  <p>Top view dimensions: Pin 1 to 3, Pin 4 to 6, width 6.4 ± 0.25, pin pitch 7.12 ± 0.25.</p> <p>Side view dimensions: Pin height $3.65^{+0.15}_{-0.25}$, pin width 0.25 min, pin length 2.54 ± 0.25, pin spacing 0.5 ± 0.1, pin offset 1.2 ± 0.15, total length 2.5.</p> <p>Bottom view dimensions: Pin width $0.25^{+0.1}_{-0.05}$, pin length 10.16 ± 0.25, pin spacing 7.62 ± 0.25, pin length 10 to 12.</p>
5-pin DIP6 (Cut)	DIP16
<p>Unit: mm</p>  <p>Top view dimensions: Pin 1 to 3, Pin 4 to 6, width 6.4 ± 0.25, pin pitch 7.12 ± 0.25.</p> <p>Side view dimensions: Pin height $3.65^{+0.15}_{-0.25}$, pin width 0.8 ± 0.25, pin length 2.54 ± 0.25, pin spacing 0.5 ± 0.1, pin offset 1.2 ± 0.15, total length 2.5.</p> <p>Bottom view dimensions: Pin width $0.25^{+0.1}_{-0.05}$, pin length 7.62 ± 0.25, pin spacing 7.85 to 8.80.</p>	<p>Unit: mm</p>  <p>Top view dimensions: Pin 1 to 16, width 6.4 ± 0.25, pin pitch 19.82 ± 0.25.</p> <p>Side view dimensions: Pin height $3.65^{+0.15}_{-0.25}$, pin width 0.8 ± 0.25, pin length 2.54 ± 0.25, pin spacing 0.5 ± 0.1, pin offset 1.2 ± 0.15, total length 2.5 min.</p> <p>Bottom view dimensions: Pin width $0.25^{+0.1}_{-0.05}$, pin length 7.62 ± 0.25, pin spacing 7.85 to 8.80.</p>

5 Package Information

*All dimensions are for reference only unless tolerance is given.

2 Package Dimensions (Surface Mount)

<p style="text-align: center;">5-pin SO6</p> <p style="text-align: right;">Unit: mm</p> <p>Top view dimensions: 4.55 (+0.25/-0.15) mm, 3.7 (+0.25/-0.15) mm. Pin 1 to 6. Lead height: 2.1 ± 0.1 mm. Lead thickness: 0.1 mm. Lead width: 0.4 mm. Lead length: 1.27 mm. Pad length: 2.54 mm. Body length: 7.0 ± 0.4 mm. Lead thickness: 0.5 min.</p>	<p style="text-align: center;">SO8</p> <p style="text-align: right;">Unit: mm</p> <p>Top view dimensions: 3.95 ± 0.25 mm, 5.1 ± 0.2 mm, 6.0 ± 0.2 mm. Pin 1 to 8. Lead height: 2.5 ± 0.2 mm. Lead thickness: 0.1 ± 0.1 mm. Lead width: 0.38 mm. Lead length: 1.27 ± 0.15 mm. Pad length: 0.305 min. Body length: 7.0 ± 0.4 mm. Lead thickness: 0.5 min.</p>
<p style="text-align: center;">SO4</p> <p style="text-align: right;">Unit: mm</p> <p>Top view dimensions: 2.6 (+0.25/-0.15) mm, 4.55 (+0.25/-0.15) mm. Pin 1 to 4. Lead height: 2.1 ± 0.1 mm. Lead thickness: 0.1 mm. Lead width: 0.38 ± 0.1 mm. Lead length: 1.27 mm. Pad length: 0.15 mm. Body length: 7.0 ± 0.4 mm. Lead thickness: 0.5 min.</p>	<p style="text-align: center;">SO16</p> <p style="text-align: right;">Unit: mm</p> <p>Top view dimensions: 10.3 (+0.25/-0.15) mm, 4.55 (+0.25/-0.15) mm. Pin 1 to 16. Lead height: 2.1 ± 0.1 mm. Lead thickness: 0.1 mm. Lead width: 0.38 ± 0.1 mm. Lead length: 1.27 mm. Pad length: 0.4 ± 0.1 mm. Body length: 7.0 ± 0.4 mm. Lead thickness: 0.5 min.</p>
<p style="text-align: center;">4-pin SO6</p> <p style="text-align: right;">Unit: mm</p> <p>Top view dimensions: 4.55 (+0.25/-0.15) mm, 3.7 (+0.25/-0.15) mm. Pin 1 to 4. Lead height: 2.1 ± 0.1 mm. Lead thickness: 0.1 mm. Lead width: 0.4 mm. Lead length: 1.27 mm. Pad length: 2.54 ± 0.25 mm. Body length: 7.0 ± 0.4 mm. Lead thickness: 0.5 min.</p>	<p style="text-align: center;">SDIP6</p> <p style="text-align: right;">Unit: mm</p> <p>Top view dimensions: 4.58 ± 0.25 mm, 6.8 ± 0.25 mm. Pin 1 to 6. Lead height: 3.65 (+0.15/-0.25) mm. Lead thickness: 0.25 ± 0.05 mm. Lead width: 0.4 ± 0.1 mm. Lead length: 1.27 ± 0.2 mm. Pad length: 1.25 ± 0.25 mm. Body length: 7.62 ± 0.25 mm. Lead thickness: 4.0 (+0.25/-0.20) mm.</p>

*All dimensions are for reference only unless tolerance is given.

2 Package Dimensions (Surface Mount)(Continued)

SDIP6 (F type)

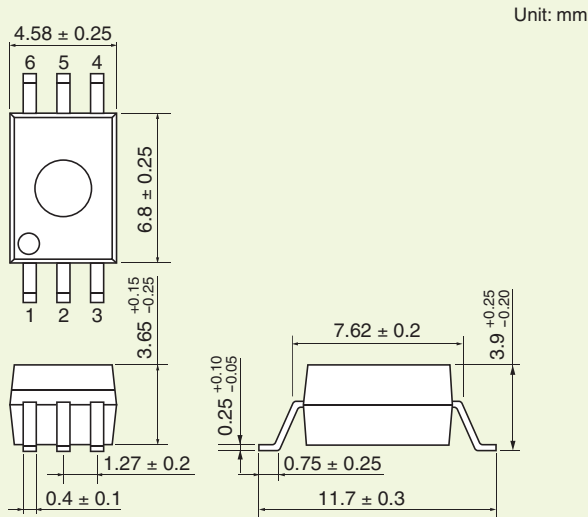

4-pin MFSOP6

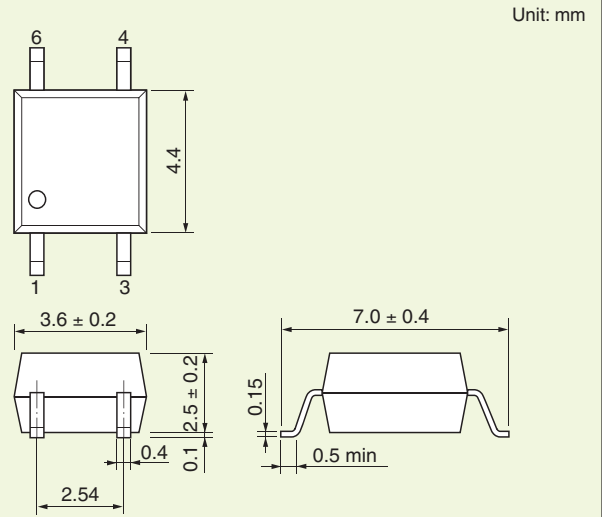

5-pin MFSOP6

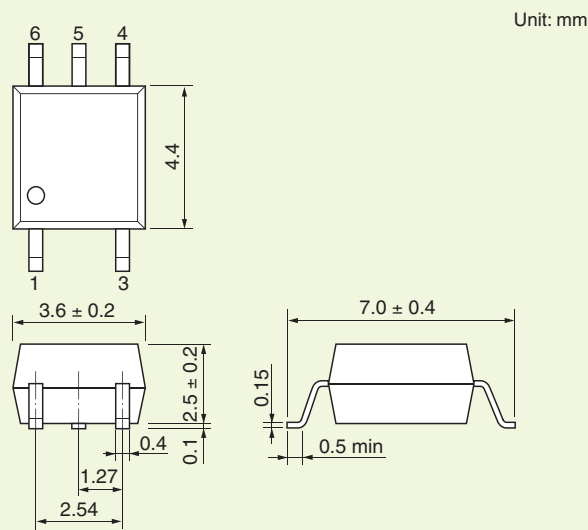

4-pin MFSOP6 (No.5Cut)

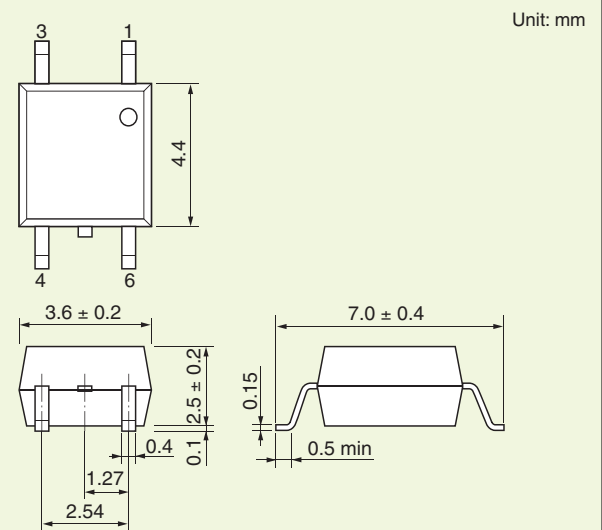

SOP4

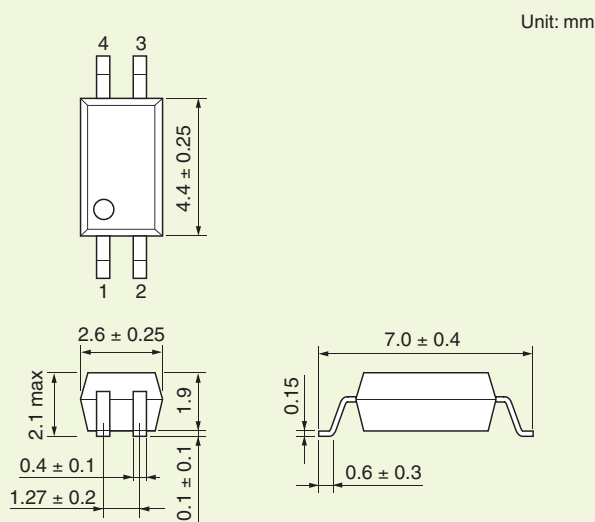

2.54SOP4

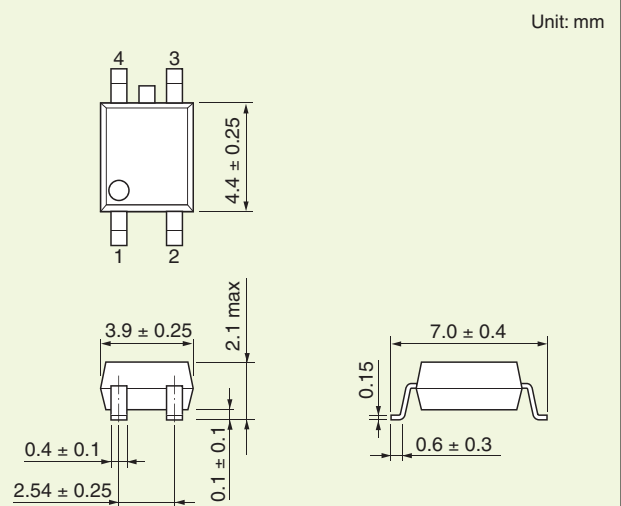

5 Package Information

*All dimensions are for reference only unless tolerance is given.

2 Package Dimensions (Surface Mount)(Continued)

<p style="text-align: center;">2.54SOP6</p> <p style="text-align: right;">Unit: mm</p>	<p style="text-align: center;">2.54SOP8</p> <p style="text-align: right;">Unit: mm</p>
<p style="text-align: center;">SOP16</p> <p style="text-align: right;">Unit: mm</p>	<p style="text-align: center;">SSOP4</p> <p style="text-align: right;">Unit: mm</p> <p style="text-align: center;">BOTTOM VIEW</p>
<p style="text-align: center;">USOP4</p> <p style="text-align: right;">Unit: mm</p> <p style="text-align: center;">BOTTOM VIEW</p>	<p style="text-align: center;">SO6L</p> <p style="text-align: right;">Unit: mm</p>
<p style="text-align: center;">SO16L</p> <p style="text-align: right;">Unit: mm</p>	<p style="text-align: center;">VSON4</p> <p style="text-align: right;">Unit: mm</p> <p style="text-align: center;">BOTTOM VIEW</p>

3 Rank Marking

Transistor-output photocouplers are ranked according to their CTR ranges, whereas thyristor-output and triac-output photocouplers are ranked according to their maximum I_{FT} value. The following gives the rank classifications and rank marks printed on packages. Note that the rank classifications differ from product to product. For details, please refer to the relevant technical datasheets.

1. CTR Rank Name and Rank Marking

Available CTR Rank Selection (○: Available, △: Contact Toshiba)

Part Number	Rank Name									
	None	BV	Y	GR	GB	BL	YH	GRL	GRH	BLL
TLP124	○	○								
TLP126	○									
TLP130	○				○					
TLP131	○		○	○	○					
TLP182	○		○	○	○	○				
TLP183	○		○	○	○	○	○	○	○	○
TLP184(SE)	○		○	○	○	○				
TLP185(SE)	○		○	○	○	○	○	○	○	○
TLP188	○				○					
TLP280-4	○				○					
TLP281-4	○				○					
TLP290(SE)	○		○	○	○	○				
TLP290-4	○				○					
TLP291(SE)	○		○	○	○	○	○	○	○	○
TLP291-4	○				○					
TLP292	○		○	○	○	○				
TLP292-4	○				○					
TLP293	○		○	○	○	○	○	○	○	○
TLP293-4	○				○					
TLP331	○	○								
TLP332	○	○								
TLP385	○		○	○	○	○	○	○	○	○
TLP531	○		○	○	○	○				
TLP532	○		○	○	○	○				
TLP620	○		△	○	○	△				
TLP624	○	○								
TLP626	○	○								
TLP628	○				○					
TLP630	○		△	○	○	△				
TLP631	○		△	○	○	△				
TLP632	○		△	○	○	△				
TLP731	○		△	○	○	△				
TLP732	○		△	○	○	△				
TLP785	○		○	○	○	○	○	○	○	○

Part Number	Rank Name	CTR	CTR Rank
TLP183 TLP185(SE) TLP291(SE) TLP293 TLP385 TLP785	None	50 to 600%	Blank, YE, GR, GB, BL, Y+, G, G+, B
	Y	50 to 150%	YE
	GR	100 to 300%	GR
	GB	100 to 600%	GB
	BL	200 to 600%	BL
	YH	75 to 150%	Y+
	GRL	100 to 200%	G
	GRH	150 to 300%	G+
BLL	200 to 400%	B	

Part Number	Rank Name	CTR	CTR Rank
TLP531 TLP532 TLP620 TLP630 TLP631 TLP632 TLP731 TLP732	None	50 to 600%	Blank, YE, GR, GB, BL
	Y	50 to 150%	YE
	GR	100 to 300%	GR
	GB	100 to 600%	GB
	BL	200 to 600%	BL

Part Number	Rank Name	CTR	CTR Rank
TLP182 TLP292	None	50 to 600%	Blank, YE, GR, GB, BL
	Y	50 to 150%	YE
	GR	100 to 300%	GR
	GB	100 to 600%	GB
	BL	200 to 600%	BL

Part Number	Rank Name	CTR	CTR Rank
TLP131	None	50 to 600%	Blank, YE, GR, GB
	Y	50 to 150%	YE
	GR	100 to 300%	GR
	GB	100 to 600%	GB

Part Number	Rank Name	CTR	CTR Rank
TLP184(SE) TLP290(SE)	None	50 to 600%	Blank, YE, GR, GB, Y+, G, G+, B
	Y	50 to 150%	YE
	GR	100 to 300%	GR
	GB	100 to 600%	GB
	BL	200 to 600%	BL

Part Number	Rank Name	CTR	CTR Rank
TLP124 TLP331 TLP332 TLP624 TLP626	None	100 to 1200%	Blank, BV
	BV	200 to 1200%	BV

Part Number	Rank Name	CTR	CTR Rank
TLP290-4 TLP291-4	None	50 to 400%	Blank
	GB	100 to 400%	GB

Part Number	Rank Name	CTR	CTR Rank
TLP130 TLP280-4 TLP281-4 TLP620-2 TLP620-4	None	50 to 600%	Blank, GB
	GB	100 to 600%	GB

Part Number	Rank Name	CTR	CTR Rank
TLP188 TLP292-4 TLP293-4	None	50 to 600%	Blank
	GB	100 to 600%	GB

Part Number	Rank Name	CTR	CTR Rank
TLP126	None	50 to 1200%	Blank

Part Number	Rank Name	CTR	CTR Rank
TLP628	None	50 to 600%	Blank, Y, Y [■] , YE, G, G [■] , GR, B, B [■] , BL, GB
	GB	100 to 600%	GB

5 Package Information

2. LED Trigger Current (IFT) Ranking and Marking

Rank Name	IFT	IFT Rank Marking
None	IFT max	Blank, T7, T5
IFT7	7 mA max	T7, T5
IFT5	5 mA max	T5
IFT2	2 mA max	T2

3. Marking Examples

(a) 4-pin DIP, 5-pin SO6, SO8, mini-flat (1 ch)

(b) 4-pin SO6, SO6L

(c) SO4

(d) Others

Note: When ordering a standard photocoupler, add a CTR or IFT rank in parentheses to the standard part number.

Examples: **TLP185(GB)** **TLP785(GR)**

Use the standard part number when applying for safety standard approval.

Example $\frac{\text{Part number}}{\text{TLP291(GB)}} \rightarrow \frac{\text{Use this part number}}{\text{TLP291}}$

6 Packing Information

1 Photocoupler Magazine Packing Specifications

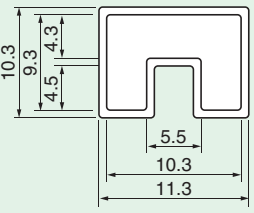
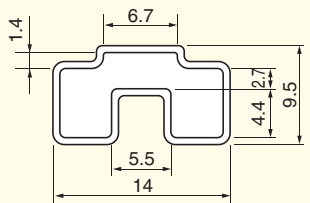
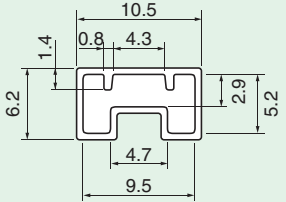
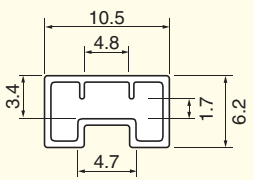
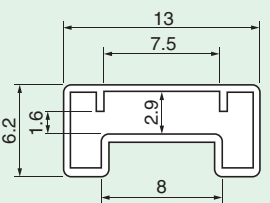
	Magazine Dimensions*	Device Quantities per Magazine	Packing Dimensions*																						
Standard DIP	<p>Unit: mm</p>  <p>Length = 525 Thickness = 0.5</p>	<table border="1"> <tr> <td>Package Pin Count</td> <td>4</td> <td>6</td> <td>8</td> <td>16</td> </tr> <tr> <td>Quantity (pcs)</td> <td>100</td> <td>50</td> <td>50</td> <td>25</td> </tr> </table>	Package Pin Count	4	6	8	16	Quantity (pcs)	100	50	50	25	<table border="1"> <thead> <tr> <th>Number of Magazines</th> <th>Dimensions (A x B x C)</th> <th>Label Position</th> </tr> </thead> <tbody> <tr> <td>4</td> <td>50 x 12 x 531</td> <td>Y</td> </tr> <tr> <td>20</td> <td>67 x 51 x 559</td> <td>Y</td> </tr> <tr> <td>60</td> <td>123 x 76 x 568</td> <td>X</td> </tr> </tbody> </table>	Number of Magazines	Dimensions (A x B x C)	Label Position	4	50 x 12 x 531	Y	20	67 x 51 x 559	Y	60	123 x 76 x 568	X
			Package Pin Count	4	6	8	16																		
Quantity (pcs)	100	50	50	25																					
Number of Magazines	Dimensions (A x B x C)	Label Position																							
4	50 x 12 x 531	Y																							
20	67 x 51 x 559	Y																							
60	123 x 76 x 568	X																							
DIPs with LF1, LF2, LF4 and LF5 Lead Forming	<p>Unit: mm</p>  <p>Length = 525 Thickness = 0.5</p>	<table border="1"> <tr> <td>Package Pin Count</td> <td>4</td> <td>6</td> <td>8</td> <td>16</td> </tr> <tr> <td>Quantity (pcs)</td> <td>100</td> <td>50</td> <td>50</td> <td>25</td> </tr> </table>	Package Pin Count	4	6	8	16	Quantity (pcs)	100	50	50	25	<table border="1"> <thead> <tr> <th>Number of Magazines</th> <th>Dimensions (A x B x C)</th> <th>Label Position</th> </tr> </thead> <tbody> <tr> <td>4</td> <td>60 x 13 x 531</td> <td>Y</td> </tr> <tr> <td>40</td> <td>135 x 58 x 568</td> <td>X</td> </tr> </tbody> </table>	Number of Magazines	Dimensions (A x B x C)	Label Position	4	60 x 13 x 531	Y	40	135 x 58 x 568	X			
Package Pin Count	4	6	8	16																					
Quantity (pcs)	100	50	50	25																					
Number of Magazines	Dimensions (A x B x C)	Label Position																							
4	60 x 13 x 531	Y																							
40	135 x 58 x 568	X																							
SO4	<p>Unit: mm</p>  <p>Length = 555 Thickness = 0.5</p>	<table border="1"> <tr> <td>Package Pin Count</td> <td>4 (SO4)</td> </tr> <tr> <td>Quantity (pcs)</td> <td>175</td> </tr> </table>	Package Pin Count	4 (SO4)	Quantity (pcs)	175	<table border="1"> <thead> <tr> <th>Number of Magazines</th> <th>Dimensions (A x B x C)</th> <th>Label Position</th> </tr> </thead> <tbody> <tr> <td>40</td> <td>71 x 32 x 584</td> <td>X</td> </tr> </tbody> </table>	Number of Magazines	Dimensions (A x B x C)	Label Position	40	71 x 32 x 584	X												
Package Pin Count	4 (SO4)																								
Quantity (pcs)	175																								
Number of Magazines	Dimensions (A x B x C)	Label Position																							
40	71 x 32 x 584	X																							
SO6	<p>Unit: mm</p>  <p>Length = 555 Thickness = 0.5</p>	<table border="1"> <tr> <td>Package Pin Count</td> <td>4 or 5 (SO6)</td> </tr> <tr> <td>Quantity (pcs)</td> <td>125</td> </tr> </table>	Package Pin Count	4 or 5 (SO6)	Quantity (pcs)	125	<table border="1"> <thead> <tr> <th>Number of Magazines</th> <th>Dimensions (A x B x C)</th> <th>Label Position</th> </tr> </thead> <tbody> <tr> <td>40</td> <td>70 x 55 x 585</td> <td>X</td> </tr> </tbody> </table>	Number of Magazines	Dimensions (A x B x C)	Label Position	40	70 x 55 x 585	X												
Package Pin Count	4 or 5 (SO6)																								
Quantity (pcs)	125																								
Number of Magazines	Dimensions (A x B x C)	Label Position																							
40	70 x 55 x 585	X																							
SO6L	<p>Unit: mm</p>  <p>Length = 555 Thickness = 0.5</p>	<table border="1"> <tr> <td>Package Pin Count</td> <td>6 (SO6L)</td> </tr> <tr> <td>Quantity (pcs)</td> <td>125</td> </tr> </table>	Package Pin Count	6 (SO6L)	Quantity (pcs)	125	<table border="1"> <thead> <tr> <th>Number of Magazines</th> <th>Dimensions (A x B x C)</th> <th>Label Position</th> </tr> </thead> <tbody> <tr> <td>20</td> <td>70 x 55 x 585</td> <td>X</td> </tr> </tbody> </table>	Number of Magazines	Dimensions (A x B x C)	Label Position	20	70 x 55 x 585	X												
Package Pin Count	6 (SO6L)																								
Quantity (pcs)	125																								
Number of Magazines	Dimensions (A x B x C)	Label Position																							
20	70 x 55 x 585	X																							

*All dimensions are typical values.

6 Packing Information

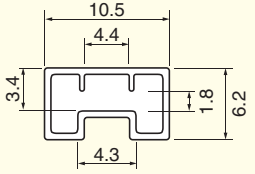
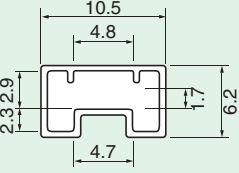
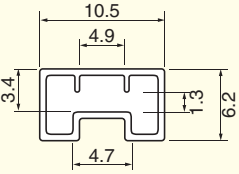
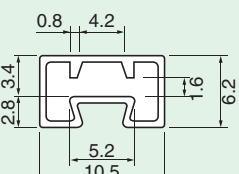
	Magazine Dimensions*	Device Quantities per Magazine	Packing Dimensions*																		
SO8	Unit: mm  Length = 555 Thickness = 0.5	<table border="1"> <tr> <td>Package Pin Count</td> <td>8 (SO8)</td> </tr> <tr> <td>Quantity (pcs)</td> <td>100</td> </tr> </table>	Package Pin Count	8 (SO8)	Quantity (pcs)	100	<table border="1"> <tr> <th>Number of Magazines</th> <th>Dimensions (A x B x C)</th> <th>Label Position</th> </tr> <tr> <td>24</td> <td>75 x 29 x 579</td> <td>X</td> </tr> </table>	Number of Magazines	Dimensions (A x B x C)	Label Position	24	75 x 29 x 579	X								
		Package Pin Count	8 (SO8)																		
Quantity (pcs)	100																				
Number of Magazines	Dimensions (A x B x C)	Label Position																			
24	75 x 29 x 579	X																			
SO16	Unit: mm  Length = 555 Thickness = 0.5	<table border="1"> <tr> <td>Package Pin Count</td> <td>16 (SO16)</td> </tr> <tr> <td>Quantity (pcs)</td> <td>50</td> </tr> </table>	Package Pin Count	16 (SO16)	Quantity (pcs)	50	<table border="1"> <tr> <th>Number of Magazines</th> <th>Dimensions (A x B x C)</th> <th>Label Position</th> </tr> <tr> <td>40</td> <td>61 x 56 x 586</td> <td>X</td> </tr> </table>	Number of Magazines	Dimensions (A x B x C)	Label Position	40	61 x 56 x 586	X								
		Package Pin Count	16 (SO16)																		
Quantity (pcs)	50																				
Number of Magazines	Dimensions (A x B x C)	Label Position																			
40	61 x 56 x 586	X																			
MFSOP6	Unit: mm  Length = 555 Thickness = 0.5	<table border="1"> <tr> <td>Package Pin Count</td> <td>4 or 5 (MFSOP6)</td> </tr> <tr> <td>Quantity (pcs)</td> <td>150</td> </tr> </table>	Package Pin Count	4 or 5 (MFSOP6)	Quantity (pcs)	150	<table border="1"> <tr> <th>Number of Magazines</th> <th>Dimensions (A x B x C)</th> <th>Label Position</th> </tr> <tr> <td>4</td> <td>29 x 13 x 563</td> <td>Y</td> </tr> <tr> <td>24</td> <td>77 x 31 x 586</td> <td>Y</td> </tr> <tr> <td>40</td> <td>67 x 55 x 586</td> <td>X</td> </tr> </table>	Number of Magazines	Dimensions (A x B x C)	Label Position	4	29 x 13 x 563	Y	24	77 x 31 x 586	Y	40	67 x 55 x 586	X		
		Package Pin Count	4 or 5 (MFSOP6)																		
		Quantity (pcs)	150																		
Number of Magazines	Dimensions (A x B x C)	Label Position																			
4	29 x 13 x 563	Y																			
24	77 x 31 x 586	Y																			
40	67 x 55 x 586	X																			
SOP Photocoupler	Unit: mm  Length = 555 Thickness = 0.5	<table border="1"> <tr> <td>Package Pin Count</td> <td>4 (SOP4)</td> <td>16 (SOP16)</td> </tr> <tr> <td>Quantity (pcs)</td> <td>150</td> <td>50</td> </tr> </table>	Package Pin Count	4 (SOP4)	16 (SOP16)	Quantity (pcs)	150	50	<table border="1"> <tr> <th>Number of Magazines</th> <th>Dimensions (A x B x C)</th> <th>Label Position</th> </tr> <tr> <td>4</td> <td>29 x 13 x 563</td> <td>Y</td> </tr> <tr> <td>24</td> <td>77 x 31 x 586</td> <td>Y</td> </tr> <tr> <td>40</td> <td>67 x 55 x 586</td> <td>X</td> </tr> </table>	Number of Magazines	Dimensions (A x B x C)	Label Position	4	29 x 13 x 563	Y	24	77 x 31 x 586	Y	40	67 x 55 x 586	X
		Package Pin Count	4 (SOP4)	16 (SOP16)																	
		Quantity (pcs)	150	50																	
Number of Magazines	Dimensions (A x B x C)	Label Position																			
4	29 x 13 x 563	Y																			
24	77 x 31 x 586	Y																			
40	67 x 55 x 586	X																			
<table border="1"> <tr> <td>Package Pin Count</td> <td>4 (2.54SOP4)</td> <td>6 (2.54SOP6)</td> <td>8 (2.54SOP8)</td> </tr> <tr> <td>Quantity (pcs)</td> <td>100</td> <td>75</td> <td>50</td> </tr> </table>	Package Pin Count	4 (2.54SOP4)	6 (2.54SOP6)	8 (2.54SOP8)	Quantity (pcs)	100	75	50													
Package Pin Count	4 (2.54SOP4)	6 (2.54SOP6)	8 (2.54SOP8)																		
Quantity (pcs)	100	75	50																		

*All dimensions are typical values.

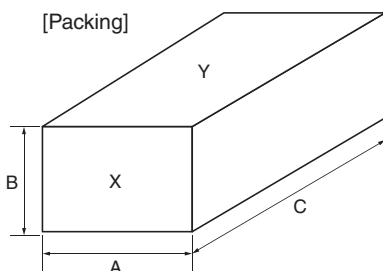

2 Tape-and-Reel Specifications

1. Embossed Tape Specifications for Surface-Mount Lead Form Options

Photocoupler Package Types	Tape Option Symbol	Typical Devices
VSON4	(TP)	TLP3403, TLP3412, TLP3417, TLP3420, TLP3440, TLP3475
MFSOP6	(TPL) or (TPR)	TLP165J, TLP190B, TLP127
SO6	(TPL) or (TPR)	TLP185(SE), TLP2301, TLP2309, TLP265J, TLP175A
SO6L	(TP)	TLP5701, TLP5702, TLP5751, TLP5752, TLP5754
SO16L	(TP)	TLP5214
SO4	(TP)	TLP290(SE), TLP291(SE), TLP292, TLP293
SOP16	(TP)	TLP280-4, TLP281-4
SO16	(TP)	TLP290-4, TLP291-4, TLP292-4, TLP293-4
2.54SOP4	(TP)	TLP176G, TLP176A, TLP176D, TLP171A
2.54SOP6	(TP)	TLP197G
2.54SOP8	(TP)	TLP200D, TLP206A, TLP206G
SSOP4	(TP15)	TLP3212, TLP3214 to TLP3217, TLP3230 to TLP3250
SDIP6	(TP)	TLP701, TLP705A, TLP719, TLP2766
DIP(LF1, LF5)	(TP1) or (TP5)	TLP550, TLP560G, TLP351A, TLP352, TLP240A
DIP(LF4)	(TP4)	TLP560G, TLP351A, TLP352, TLP240A
SO8	(TP)	TLP2168, TLP2468

2. Tape Dimensions

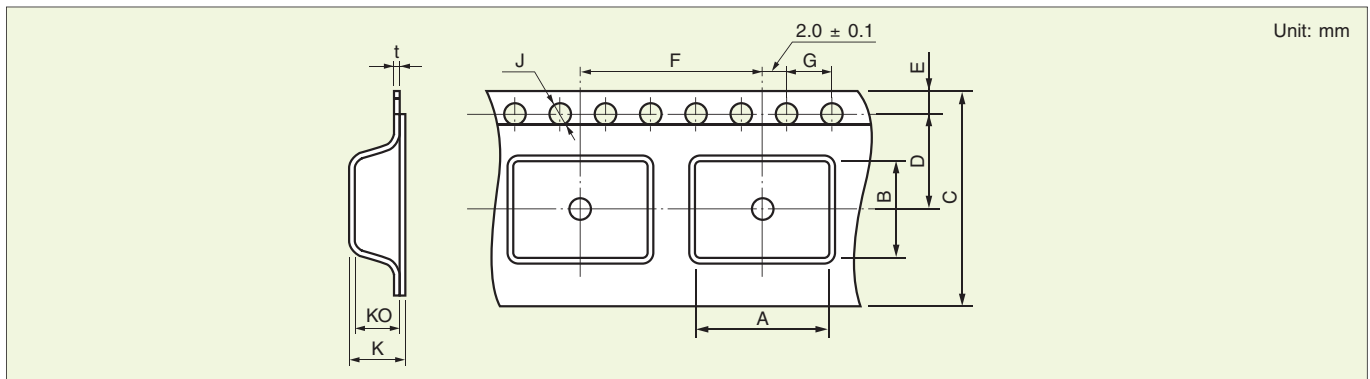

Photocoupler Package Type		VSON4	MFSOP6	SO6	SO6L	SO16L	SO8	SOP4	SO4	SOP16	SO16	2.54SOP4	2.54SOP6	2.54SOP8	SSOP4	SDIP6	SDIP6 F type	DIP (LF1, LF5)	DIP(LF4)	
Tape Option		(TP)	(TPL), (TPR)	(TPL), (TPR)	(TP)	(TP)	(TP)	(TP)	(TP)	(TP)	(TP)	(TP)	(TP)	(TP)	(TP15)	(TP)	(TP)	(TP1), (TP5)	(TP4)	
Symbol (See figure above)	A	1.6 ± 0.1	4.2 ± 0.1	4.0 ± 0.1	10.4 ± 0.1	10.4 ± 0.1	6.5 ± 0.1	3.1 ± 0.1		7.5 ± 0.1		4.3 ± 0.1	7.5 ± 0.1		2.35 ± 0.2	10.4 ± 0.1	12.3 ± 0.1	10.4 ± 0.1	12.3 ± 0.1	
	B	3.0 ± 0.1	7.6 ± 0.1		4.24 ± 0.1	10.7 ± 0.1	5.6 ± 0.1	7.5 ± 0.1		10.5 ± 0.1		7.5 ± 0.1	6.7 ± 0.1	10.5 ± 0.1	4.5 ± 0.1	5.1 ± 0.1		*1	*1	
	C	8.0 ± 0.3	12.0 ± 0.3		16.0 ± 0.3	16.0 ± 0.3	12.0 ± 0.3		16.0 ± 0.3		12.0 ± 0.3	16.0 ± 0.3		12.0 ± 0.3	16.0 ± 0.3					
	D	3.5 ± 0.1	5.5 ± 0.1		7.5 ± 0.1	7.5 ± 0.1	5.5 ± 0.1		7.5 ± 0.1		5.5 ± 0.1	7.5 ± 0.1		5.5 ± 0.1	7.5 ± 0.1					
	E	1.75 ± 0.1																		
	F	4.0 ± 0.1	8.0 ± 0.1		12.0 ± 0.1	12.0 ± 0.1	8.0 ± 0.1		12.0 ± 0.1		8.0 ± 0.1	12.0 ± 0.1	8.0 ± 0.1	12.0 ± 0.1	4.0 ± 0.1	12.0 ± 0.1	16.0 ± 0.1	12.0 ± 0.1	16.0 ± 0.1	
	G	4.0 ± 0.1																		
	J	1.5 ^{+0.1} ₋₀																		
	K	(1.8 ± 0.1)	3.15 ± 0.2	2.9 ± 0.2	(2.7 ± 0.1)	(2.7 ± 0.1)	3.4 ± 0.2	2.5 ± 0.2	3.15 ± 0.2	2.4 ± 0.2	2.6 ± 0.2	2.6 ± 0.2	2.5 ± 0.2	2.4 ± 0.2	2.4 ± 0.2	4.55 ± 0.2				
	KO	1.5 ± 0.1	2.8 ± 0.1	2.6 ± 0.1	2.4 ± 0.1	2.4 ± 0.1	3.1 ± 0.1	2.3 ± 0.1		2.2 ± 0.1		2.4 ± 0.1	2.3 ± 0.1	2.2 ± 0.1	2.1 ± 0.1	4.1 ± 0.1				
t	0.2 ± 0.05		0.3 ± 0.05																0.4 ± 0.05	

*1: Typical devices

DIP4	TLP620, TLP627, TLP240A	5.1 ± 0.1
DIP6 (short package)	TLP560G, TLP590B, TLP748J	7.6 ± 0.1
DIP8	TLP351A, TLP754	10.1 ± 0.1 (TP4) is not available

6 Packing Information

3. Reel Dimensions

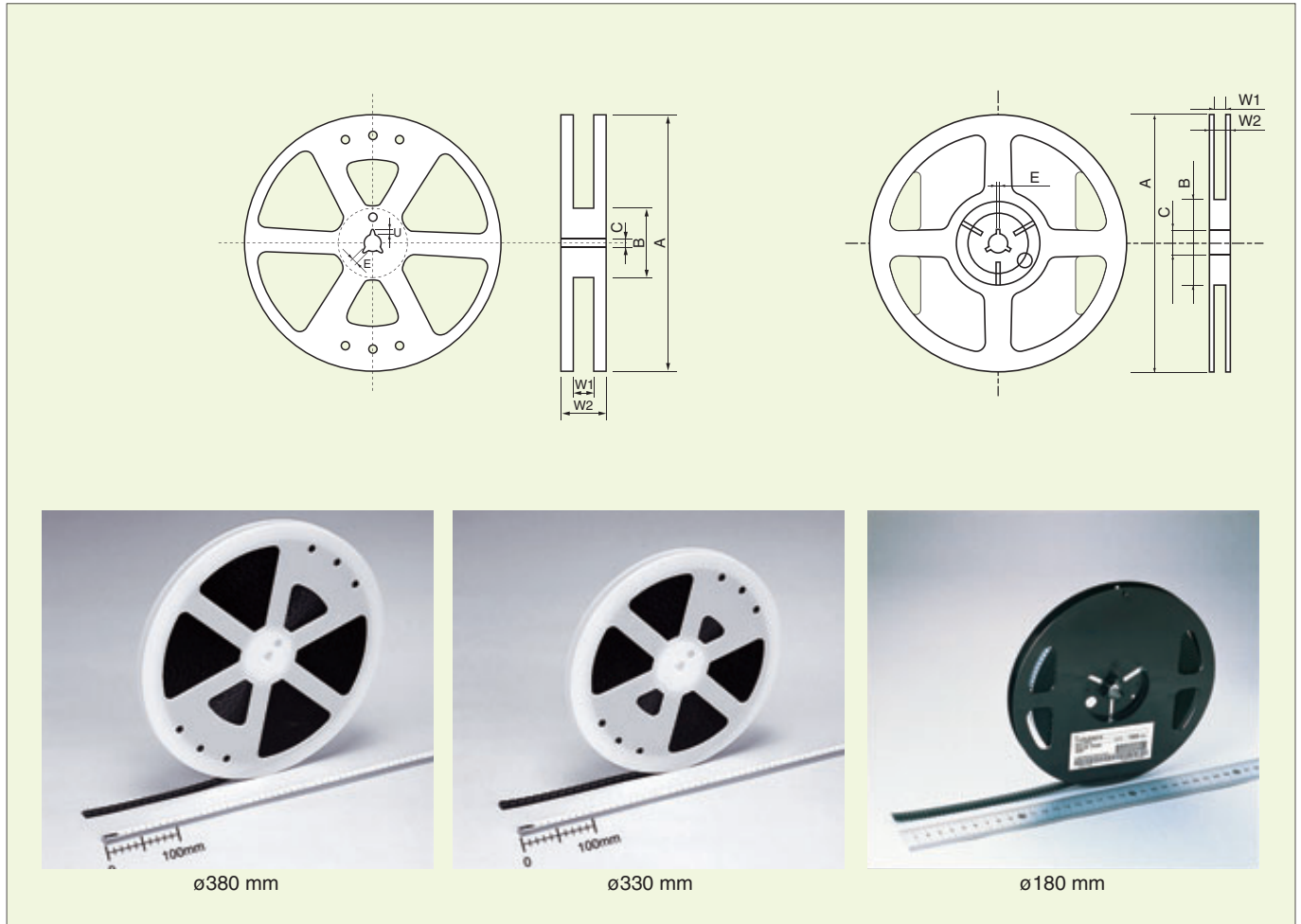

Unit: mm

Photocoupler Package Type	MFSOP, SO6	SOP4	SO4	SO6L, SO16L	SOP16	SO16	SO8	2.54SOP4	2.54SOP6	2.54SOP8	SSOP4	VSON4	SDIP6	SDIP6 F type	DIP (LF1, LF5)	DIP (LF4)		
Tape Option	(TPL), (TPR)	(TP)	(TP)	(TP)	(TP)	(TP)	(TP)	(TP)	(TP)	(TP)	(TP15)	(TP)	(TP)	(TP)	(TP1), (TP5)	(TP4)		
Symbol (See figure above)	A	ø380 ± 2		ø330 ± 2							180 ⁺⁰ ₋₄		ø180 ± 3		ø380 ± 2			
	B	ø80 ± 1		ø100 ± 1		ø80 ± 1					ø60		ø60 ± 1		ø80 ± 1			
	C	ø13 ± 0.5										ø13		ø13 ± 0.5				
	E	2.0 ± 0.5										2 ± 0.5		2.0 ± 0.5				
	U	4.0 ± 0.5																
	W1	13.5 ± 0.5		17.4 ± 1.0		17.5 ± 0.5		13.5 ± 0.5		17.5 ± 0.5		13 ± 0.3		9.0 ± 0.3		17.5 ± 0.5		
	W2	17.5 ± 1.0		21.4 ± 1.0		21.5 ± 1.0		17.5 ± 1.0		21.5 ± 1.0		15.4 ± 1.0		11.4 ± 1.0		21.5 ± 1.0		

Some products are provided in black reels.

4. Other Packing Information

a) Device orientation on tape

Photocouplers are oriented in cavity, as shown below.

Photocoupler Package Type	Tape Option
MFSOP6, SO6, SO6L	TPR

A)

Photocoupler Package Type	Tape Option
MFSOP6, SO6	TPL
SO4, SOP4, 2.54SOP4, VSON4	TP
SSOP4	TP15

B)

Photocoupler Package Type	Tape Option
SO16, SOP16, SO8, SO6L, SO16L	TP
2.54SOP6/8	TP
SDIP6, SDIP(F type)	TP
DIP(LF1, LF5)	TP1, TP5
DIP(LF4), DIP(F type)	TP4

C)

User direction of feed →

b) Tape Specifications

■ Quantities Per Reel

Photocoupler Package Type	MFSOP6, SO6, VSON4	SO6L, SO16L	SO4, SOP4, SO8	SOP16	SO16	2.54SOP4/6/8	SSOP4	SDIP6	SDIP6 F type	DIP(LF1, LF5)	DIP(LF4)
Quantity (pcs)	3000	1500	2500	2500	2000	2500	1500	1500	1000	1500	1000

■ Empty Cavities

Item	Specification	Note
Consecutive empty cavities	Zero	Any 40-mm portion of tape except leader and trailer.
Non-consecutive empty cavities	0.2% max/reel *2	Except leader and trailer.

*2: 6 pcs max/reel for DIP and SDIP packages

c) Packing boxes

One or five reels per box

d) Label

The reel label includes the following information:

1. Part number
2. Tape type
3. Quantity
4. Lot number

7 Board Assembly

1 Example Land Patterns

Unit: mm

SO6 (4-pin) MFSOP6 (4-pin) 2.54SOP4	SO6 (5-pin) MFSOP6 (5-pin)	SOP4 SO4	SSOP4	VSON4

Unit: mm

SO16L	SO6L	SO8	SOP16 SO16

Unit: mm

SDIP6	SDIP6 (F type)	DIP package* (LF1), (LF5)	DIP package* (LF4), (F type)
		<p>Example: DIP 6pin</p>	<p>Example: DIP 6pin</p>

*: For the example land patterns for the TLP781 and TLP785, see their respective datasheets.

2 Board Assembly Considerations

1. Soldering

The profile below shows only the typical temperature profile and conditions, which might not apply to all Toshiba photocouplers. Temperature profiles and conditions may differ from product to product. Refer to the relevant technical datasheets and databooks when mounting a device.

When using a soldering iron or medium infrared ray/hot air reflow, avoid a rise in device temperature as much as possible by observing the following conditions.

1.1) Using a soldering iron

- Solder once within 10 seconds for a lead temperature of up to 260°C.
- Solder once within 3 seconds for a lead temperature of up to 350°C.

1.2) Using medium infrared ray/hot air reflow

- Complete the infrared ray/hot air reflow process at once within 30 seconds at a package surface temperature between 210°C and 240°C.
- Example of temperature profile of lead (Pb)-free solder

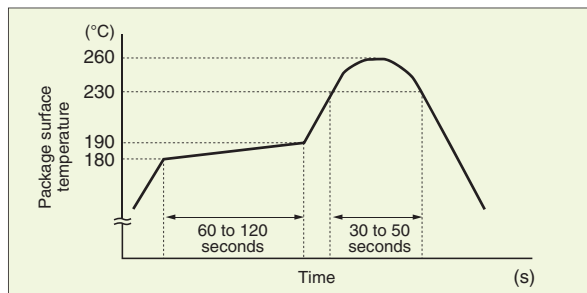

Example of temperature profile of lead (Pb)-free solder

c. Temperature Profile of JEDEC Pb-Free Solder (For Reference Only)

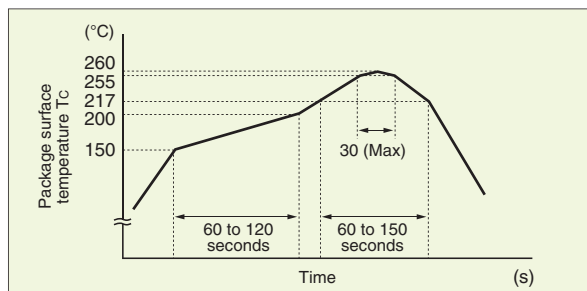

d. Precautions for heating

Keeping packages at high temperature for a long period of time can degrade the quality and reliability of devices. Soldering time has to be kept as short as possible to avoid a rise in package temperature.

When using a halogen lamp or infrared heater, avoid direct irradiation of packages, since this may cause a rise in package temperature.

1.3) Dip soldering (flow soldering)

The thermal shock of dip soldering increases thermal stress on devices. To avoid stress, the use of a soldering iron or medium infrared ray/hot air reflow is recommended. If you want to use dip soldering, contact your nearest Toshiba sales representative.

2. Flux Cleaning

- When cleaning circuit boards to remove flux, make sure that no residual reactive ions such as sodium(Na⁺) or chloride(Cl⁻) ions remain. Note that organic solvents react with water to generate hydrogen chloride and other corrosive gases, which can degrade device performance.
- Washing devices with water will not cause any problems. However, make sure that no reactive ions such as sodium(Na⁺) or chloride(Cl⁻) ions are left as residue. Also, be sure to dry devices sufficiently after washing.
- Do not rub device markings with a brush or with your hand during cleaning or while the devices are still wet from the cleaning agent. Doing so can rub off the markings.
- Dip cleaning, shower cleaning and steam cleaning processes all involve the chemical action of a solvent. Use only recommended solvents for these cleaning methods. When immersing devices in a solvent or steam bath, make sure that the temperature of the liquid is 50°C or below and that the circuit board is removed from the bath within one minute.
- If a device package allows ultrasonic cleaning, keep the duration of ultrasonic cleaning as short as possible, since long hours of ultrasonic cleaning degrade the adhesion between the mold resin and the frame material.

■ The following ultrasonic cleaning conditions are recommended.

Frequency: 27 kHz to 29 kHz

Ultrasonic output power: 300 W or less (0.25 W/cm² or less)

Cleaning time: 30 seconds or less

Suspend the circuit board in the solvent bath during ultrasonic cleaning in such a way that the ultrasonic vibrator does not come into direct contact with the circuit board or the device.

Conventional cleaning solvents that contain freon are not recommended due to its adverse effects on the earth's ozone layer. Alternative freon-free products are available on the market. Some of these alternative cleaning agents are listed in the table below.

Contact Toshiba or a Toshiba distributor regarding cleaning conditions and other relevant information for each product type.

8 Device Degradation

1 Projected Operating Life Based on LED Light Output Degradation

Toshiba photocouplers use one of four types of LEDs and a projection of the operating life has been made for each LED. The table on page 69 shows the types of LED used in photocouplers and the figures on pages 70 to 72 show projections of long-term light output performance and operating life. Note that these operating life data are estimates extrapolated from long-term light output degradation over a single wafer lot and are shown as reference only.

	Projected Operating Life ($T_a = 40^\circ\text{C}$, $I_F = 20\text{ mA}$, failure criteria: degradation rate $\Delta P_o < -50\%$)		Photocouplers
	F50% operating life	F0.1% operating life	
① GaAs LED	1,300,000 h	260,000 h	Mainly for phototransistor output devices and phototriac output devices
② GaAlAs(SH) LED	540,000 h	100,000 h	Mainly for photo-IC couplers
③ GaAlAs(DH) LED	1,000,000 h	200,000 h	Mainly for photorelays (MOSFET output), photovoltaic couplers and photo-IC couplers
④ GaAlAs(MQW) LED	Ask your local Toshiba sales representative.		Mainly for photo-IC couplers

F50% (cumulative failure rate 50%) operating life: Time period until the projected long-term light output degradation curve of the average light output change (\bar{X}) shown on pages 70 to 72 reaches the failure criteria.

F0.1% (cumulative failure rate 0.1%) operating life: Time period until the projected long-term light output degradation curve of $\bar{X} - 3\sigma$ shown on pages 70 to 72 reaches the failure criteria.

The relationship between LED light output degradation and optical coupling characteristics is shown below.

- (1) The relationship between LED light output degradation and current transfer ratio (CTR)/short circuit current (I_{sc}) is 1:1.

$$\frac{CTR(t)}{CTR(o)} = \frac{P_o(t)}{P_o(o)}$$

- (2) The relationship between a reciprocal value of LED light output degradation and $I_{FT}/I_{FLH}/I_{FHL}/I_{FH}$ change is 1:1.

$$\frac{I_{FT}(t)}{I_{FT}(o)} = \left(\frac{P_o(t)}{P_o(o)} \right)^{-1}$$

LEDs Used in Photocouplers

LED: ① GaAs ② GaAlAs (SH) ③ GaAlAs (DH) ④ GaAlAs (MQW)

Photocouplers	LED	Photocouplers	LED	Photocouplers	LED	Photocouplers	LED	Photocouplers	LED
TLP104	④	TLP224G Series	①	TLP555	②	TLP759 Series	②	TLP2766	④
TLP105	④	TLP225A	①	TLP557	②	TLP762J	①	TLP2767	★
TLP108	④	TLP227 Series	①	TLP558	②	TLP763J	①	TLP2768	④
TLP109 Series	④	TLP228 Series	①	TLP559 Series	②	TLP785	①	TLP2955	④
TLP116A	④	TLP240 Series	④	TLP560 Series	①	TLP797 Series	①	TLP2958	④
TLP117	④	TLP241A	④	TLP561 Series	①	TLP798GA	③	TLP2962	④
TLP118	④	TLP250H	④	TLP570	①	TLP2066	③	TLP3022(S)	①
TLP124	①	TLP265J	④	TLP571	①	TLP2095	④	TLP3023(S)	①
TLP126	①	TLP266J	④	TLP572	①	TLP2098	④	TLP3042(S)	①
TLP127	①	TLP267J	④	TLP590B	③	TLP2105	②	TLP3043	①
TLP130	①	TLP268J	④	TLP591B	③	TLP2108	②	TLP3052	①
TLP131	①	TLP280-4	①	TLP592 Series	①	TLP2116	②	TLP3062	①
TLP137	①	TLP281-4	①	TLP597 Series	①	TLP2118E	④	TLP3063(S)	①
TLP148G	①	TLP290-4	①	TLP598 Series	③	TLP2160	④	TLP3064	③
TLP151A	④	TLP290(SE	①	TLP620 Series	①	TLP2161	④	TLP3082	①
TLP152	④	TLP291-4	①	TLP624 Series	①	TLP2166A	②	TLP31xx Series	①
TLP155 Series	④	TLP291(SE	①	TLP626 Series	①	TLP2167	★	TLP3203	①
TLP160 Series	①	TLP292 Series	④	TLP627 Series	①	TLP2168	④	TLP321x Series	①
TLP161 Series	①	TLP293 Series	④	TLP628 Series	①	TLP2200	②	TLP3220	①
TLP163J	①	TLP331	①	TLP630	①	TLP2301	④	TLP3230	①
TLP165J	①	TLP332	①	TLP631	①	TLP2309	④	TLP3231	①
TLP166J	①	TLP350	②	TLP632	①	TLP2310	★	TLP3240	③
TLP168J	③	TLP350H	④	TLP651	②	TLP2345	★	TLP3241	③
TLP170 Series	①	TLP351	②	TLP663J	①	TLP2348	★	TLP3250	③
TLP171 Series	④	TLP351A	④	TLP665 Series	①	TLP2355	④	TLP3275	①
TLP172 Series	①	TLP351H	④	TLP666 Series	①	TLP2358	④	TLP33xx Series	①
TLP173A	①	TLP352	④	TLP668J	③	TLP2361	④	TLP34xx Series	④
TLP174G Series	①	TLP358	④	TLP669L	④	TLP2362	④	TLP35xx Series	③
TLP175A	④	TLP358H	④	TLP700	④	TLP2366	④	TLP3762(S)	①
TLP176 Series	①	TLP360J	①	TLP700A	④	TLP2367	★	TLP3782	④
TLP179D	①	TLP361J	①	TLP700H	④	TLP2368	④	TLP3783	④
TLP182	④	TLP363J	①	TLP701	②	TLP2395	④	TLP3902	①
TLP183	④	TLP371	①	TLP701A	④	TLP2398	④	TLP3904	①
TLP184(SE	①	TLP372	①	TLP701H	④	TLP2403	④	TLP3905	④
TLP185(SE	①	TLP373	①	TLP705A	④	TLP2404	④	TLP3906	④
TLP187	④	TLP385	★	TLP708	④	TLP2405	④	TLP3914	③
TLP188	④	TLP512	②	TLP714	④	TLP2408	④	TLP3924	③
TLP190B	③	TLP513	②	TLP715	②	TLP2409	④	TLP4xxx Series	①
TLP191B	③	TLP523 Series	①	TLP716	②	TLP2418	④	TLP5701	④
TLP192 Series	①	TLP525G Series	①	TLP718	②	TLP2451A	④	TLP5702	④
TLP197 Series	①	TLP531	①	TLP719	②	TLP2466	④	TLP5751	④
TLP199D	①	TLP532	①	TLP731	①	TLP2468	④	TLP5752	④
TLP200D	①	TLP548J	①	TLP732	①	TLP2530	②	TLP5754	④
TLP202 Series	①	TLP549J	①	TLP733	①	TLP2531	②	TLPN137	④
TLP206 Series	①	TLP550	②	TLP734	①	TLP2601	②	6N135	②
TLP209D	①	TLP551	②	TLP748J	①	TLP2630	②	6N136	②
TLP220 Series	④	TLP552	②	TLP750	②	TLP2631	②	6N137	②
TLP221A	④	TLP553	②	TLP751	②	TLP2662	④	6N138	②
TLP222 Series	①	TLP554	②	TLP754	④	TLP2703	④	6N139	②

★: Under development

8 Device Degradation

① GaAs LED Projected Light Output Degradation Data

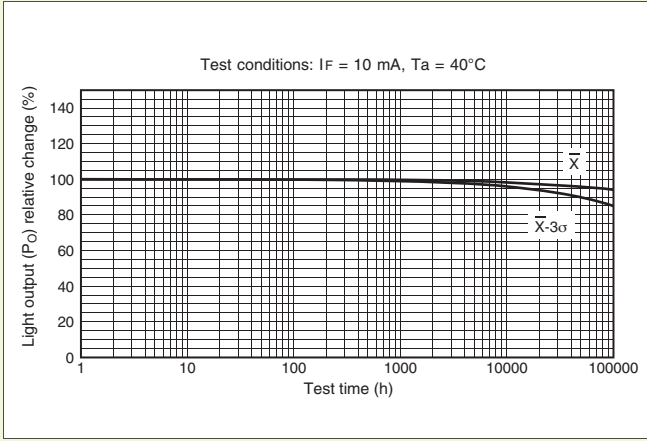
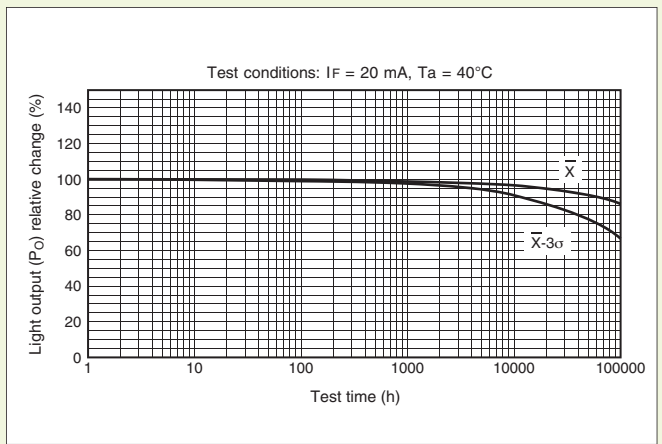
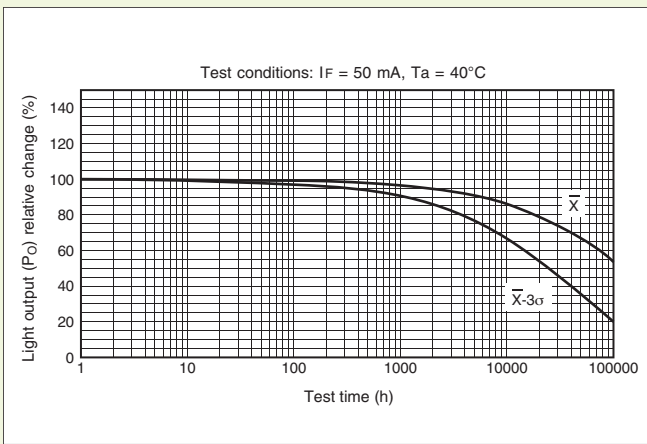

① GaAs LED Projected Operating Life Data

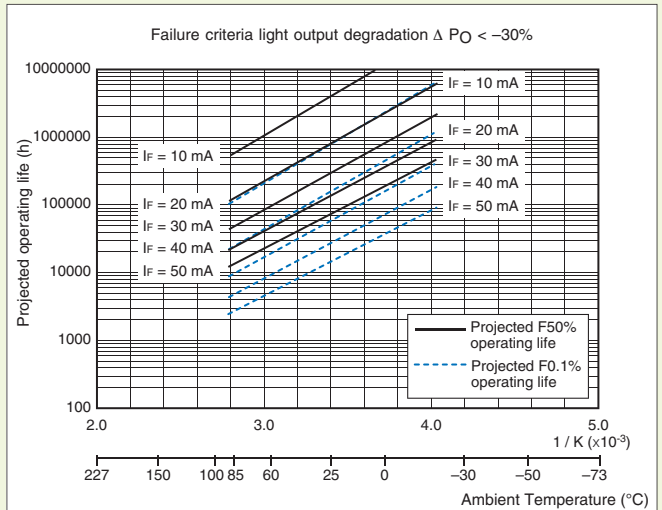
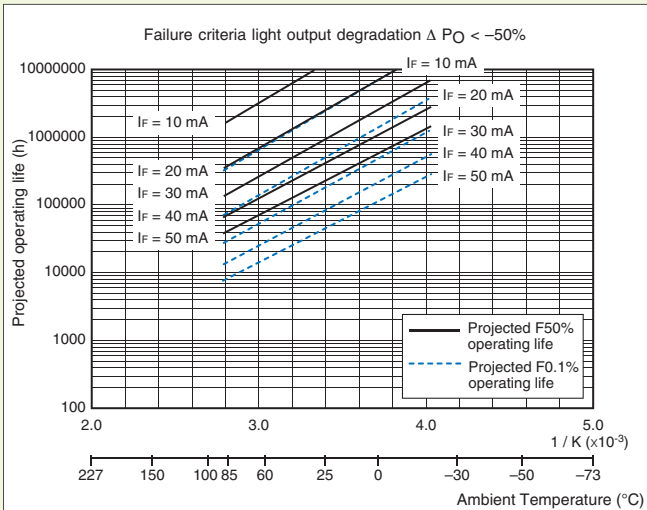

The above operating life data are estimates extrapolated from long-term light output degradation over a single wafer lot and are shown as reference only. Operating conditions exceeding the maximum ratings are not guaranteed.

② GaAlAs (SH) LED Projected Light Output Degradation Data

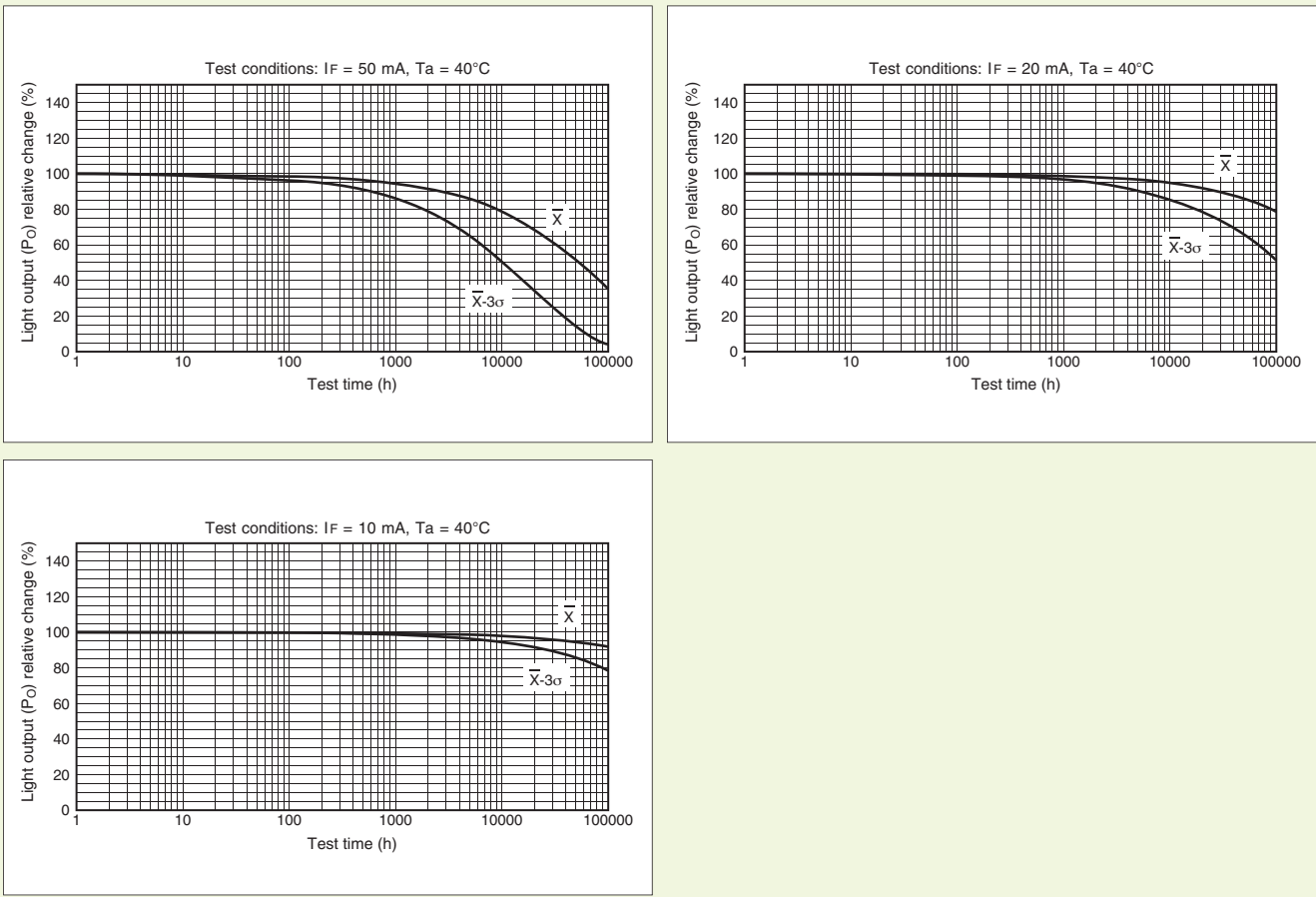

② GaAlAs (SH) LED Projected Operating Life Data

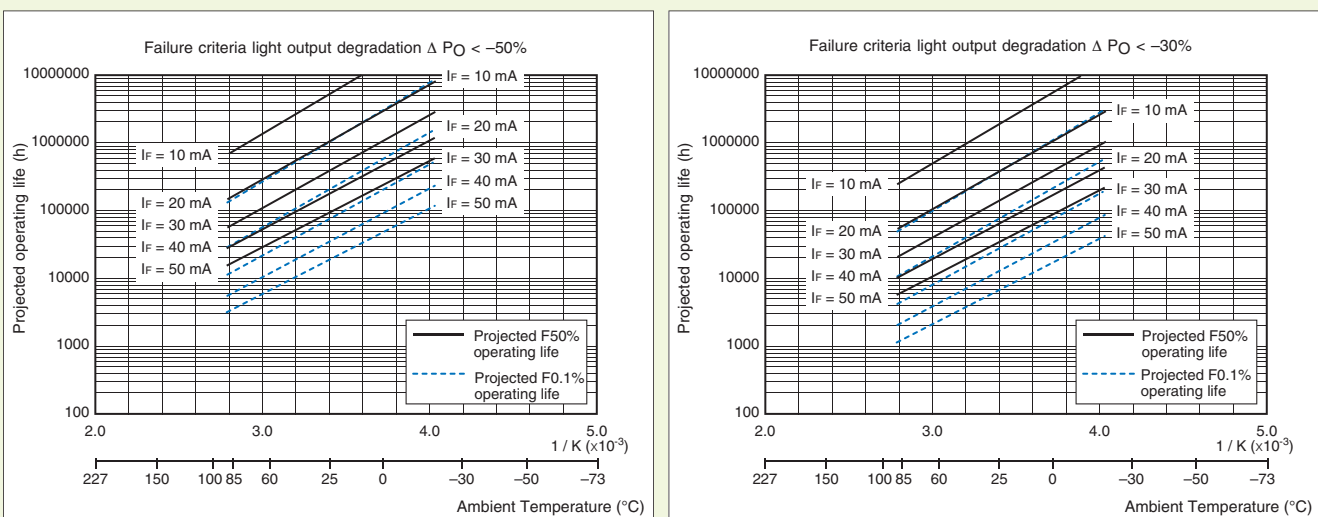

The above operating life data are estimates extrapolated from long-term light output degradation over a single wafer lot and are shown as reference only. Operating conditions exceeding the maximum ratings are not guaranteed.

8 Device Degradation

③ GaAlAs (DH) LED Projected Light Output Degradation Data

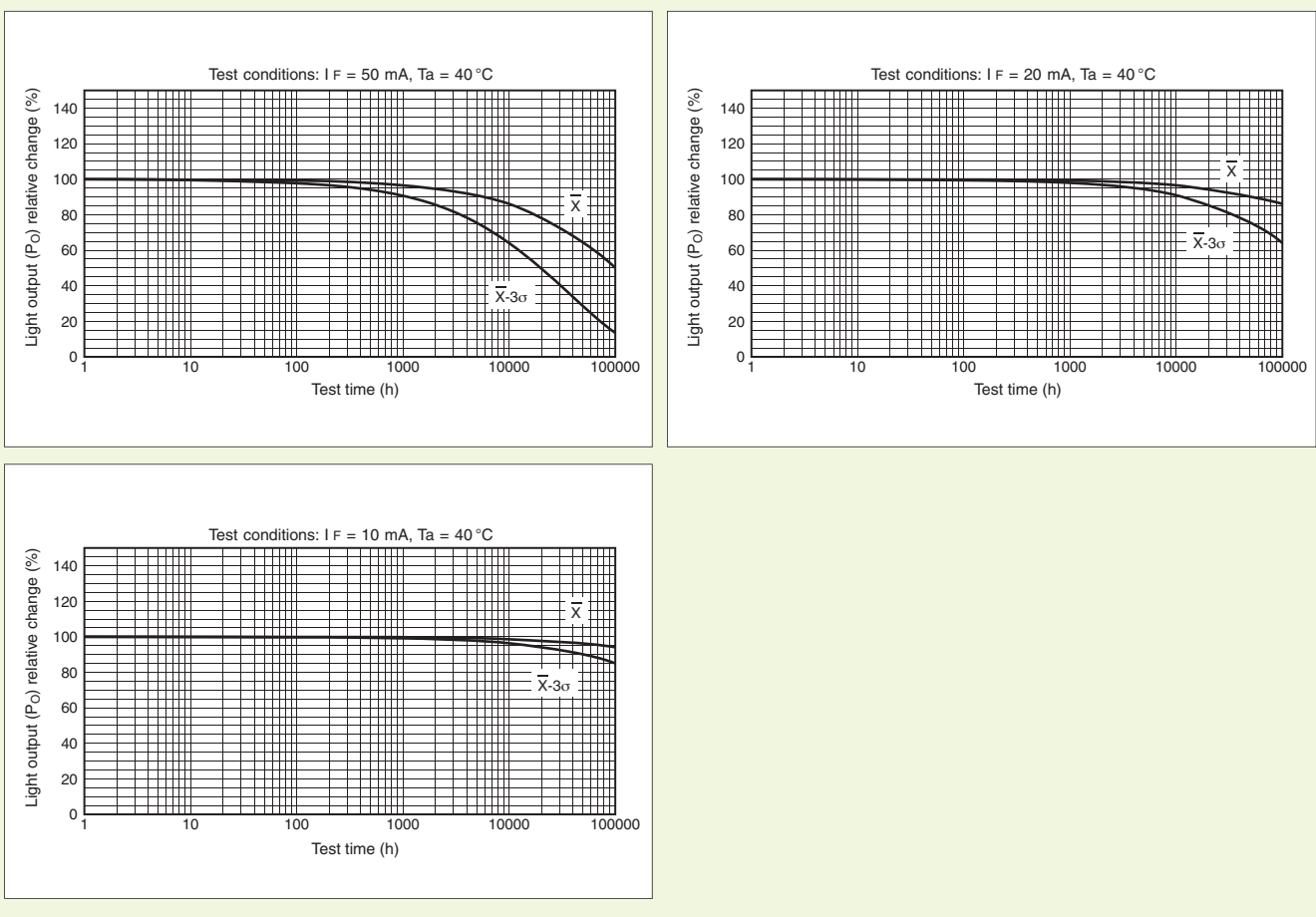

③ GaAlAs (DH) LED Projected Operating Life Data

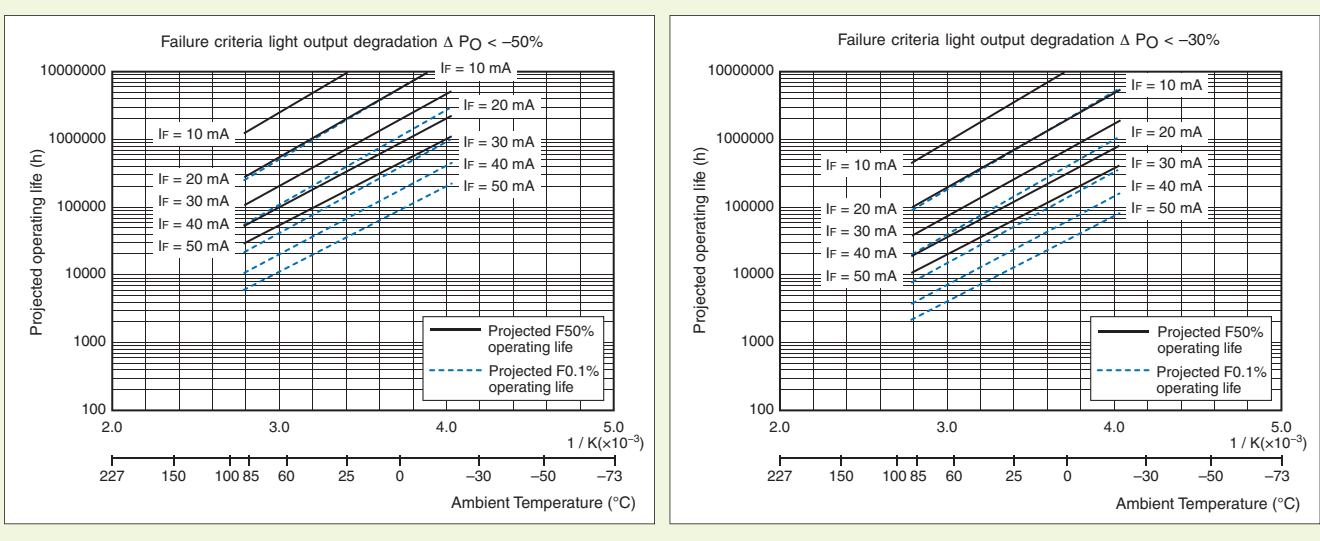

The above operating life data are estimates extrapolated from long-term light output degradation over a single wafer lot and are shown as reference only. Operating conditions exceeding the maximum ratings are not guaranteed.

④ GaAlAs (MQW) LED Projected Light Output Degradation and Operating Life Data

Toshiba is now preparing the light output degradation and operating life data for GaAlAs (MQW) LEDs. These data are available for individual LEDs. Ask your local Toshiba sales representative.

Reading the Projected LED Operating Life Graph

For example, let's calculate the operating life of the GaAs LED, based on the data shown on page 70.

Here is an example of how to read an operating life, assuming that the ambient temperature (T_a) is 40°C and that the failure criterion is a 30% decrease in light output.

Suppose that the initial LED current, I_F , is 20 mA. Since the horizontal axis of the failure criteria graph is the reciprocal of absolute temperature, it is necessary to convert the ambient temperature (T_a) to the reciprocal of absolute temperature (T):

$$T = \frac{I}{T_a + 273.15} = \frac{I}{40 + 273.15} \doteq 3.19 \times 10^{-3}$$

The graph shows the projected lifetimes for F50% and F0.1% cumulative failure probabilities in solid and dashed lines respectively. Normally, it is recommended to use F0.1% lines.

As $X = 3.19$, its intersection with the $I_F = 20$ mA line for F0.1% is approximately 80,000 hours. (This figure is for reference only.)

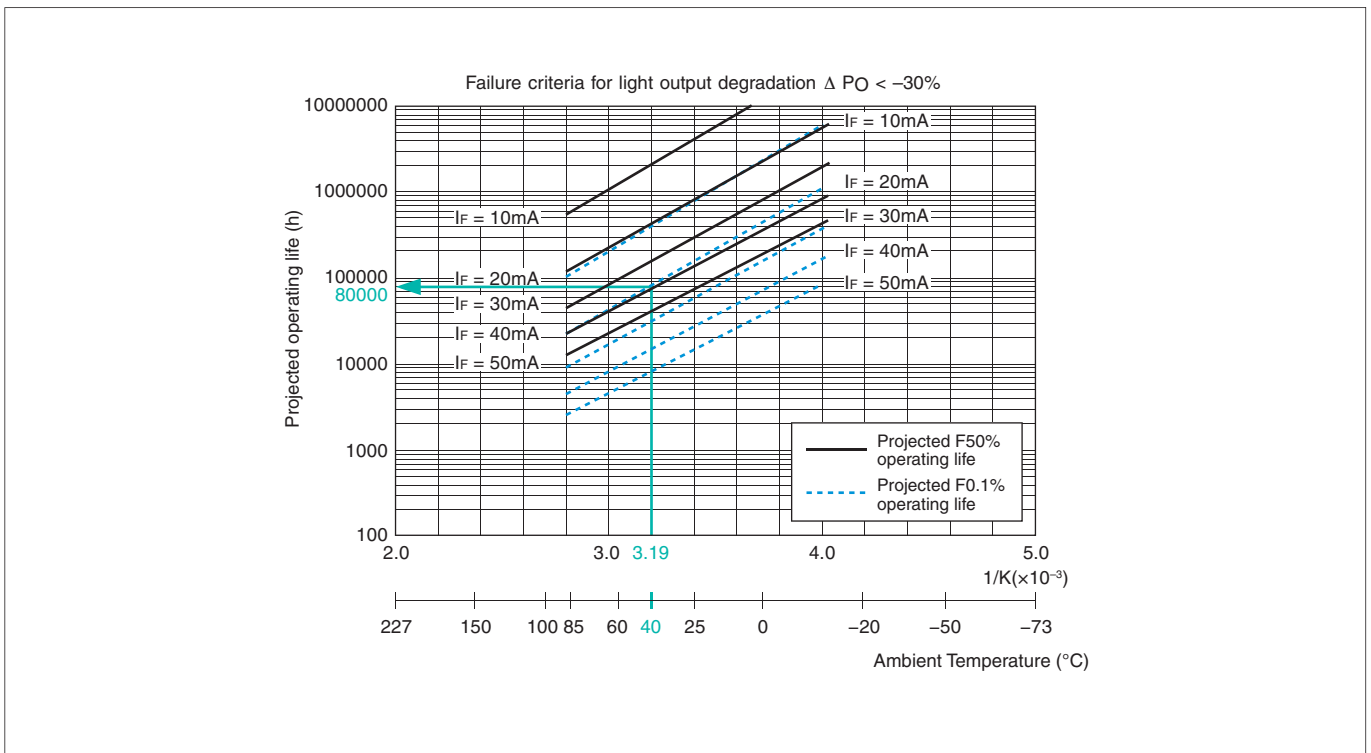

You can also estimate the projected operating life from the projected light output degradation data.

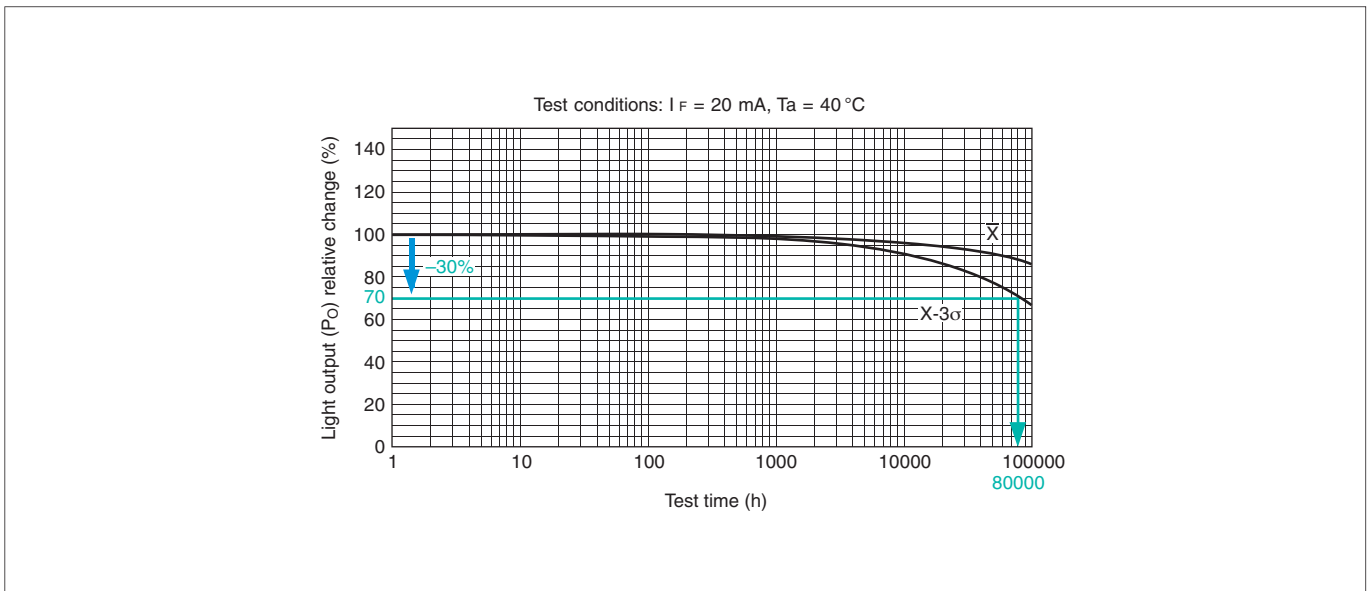

9 Safety Standard Approvals

Toshiba offers a wide selection of photocouplers with a transistor output, IC output, thyristor output and triac output, as well as photorelays certified to UL (USA), cUL (Canada), VDE (Germany), BSI (Britain), SEMKO (Sweden) and CQC (China).

Safety Standard Approvals for Photocouplers (DIN EN60747-5)

Mechanical Construction		Reflective Photocouplers in Single-Molded Packages			Transmissive Photocouplers in Single-Molded Packages				
Internal Construction									
Package		SOP4/SOP16		MFSOP6	MFSOP6	SO8 (2 ch)	2.54SOP 4/6/8	DIP	DIP (F type)
Construction Mechanical Ratings (min)	Isolation Creepage Path (mm)	4.0	5.0	4.0	4.0	4.2	4.0	6.4/7.0	8.0
	Isolation Clearance (mm)	4.0	5.0	4.0	4.0	4.2	4.0	6.4/7.0	8.0
	Isolation Thickness (mm)	0.4	0.4	0.4	–	–	–	(0.4)	(0.4)
	Internal Creepage Path (mm)	–	–	–	–	–	–	–	–
VDE/TÜV DIN EN 60747-5-5	Max. Working Insulation Voltage (Viorm)	565 Vpk	707 Vpk	565 Vpk	565 Vpk	565 Vpk	565 Vpk	630 Vpk /890 Vpk	1140 Vpk
	Highest Allowable Overvoltage (Viotm)	4000 Vpk	6000 Vpk	6000 Vpk	4000 Vpk	4000 Vpk	2500 Vpk	4000 Vpk	6000 Vpk

Certified Devices	IC Output					TLP2105 TLP2108 TLP2166A TLP2116 TLP2118E TLP2168 TLP2160		TLP350 TLP351 TLP559	TLP350F TLP351F
	Transistor Output	TLP280-4 TLP281-4				TLP127			
	Triac/Thyristor Output					TLP160G TLP160J TLP161G TLP161J TLP168J		TLP560G TLP560J TLP561G TLP561J	
	Photorelay/Photovoltaic						TLP176A TLP176D TLP176G TLP197G TLP206G	TLP227G TLP227G-2 TLP597G	

The table above lists photocouplers and photorelays that have already been approved as of August 2014.
 The information herein is subject to change. For the latest information, please contact your nearest Toshiba sales representative.

Transmissive Photocouplers with an Insulating Film in Single-Molded Packages					Transmissive Photocouplers in Double-Molded Packages							
SO8 (1 ch)	SDIP6	SDIP6 (F type)	DIP	DIP (F type)	MFSOP6	SO4	SO6	SO6L	SO16	DIP	DIP (F type)	
4.0	7.0	8.0	6.4/7.0	8.0	4.0	5.0	5.0	8.0	5.0	6.5/7.0	8.0	
4.0	7.0	8.0	6.4/7.0	8.0	4.0	5.0	5.0	8.0	5.0	6.5/7.0	8.0	
–	0.4	0.4	0.4/0.5	0.4/0.5	–	0.4	0.4	0.4	–	0.4/0.5	0.4/0.5	
–	–	–	–	–	–	–	–	–	–	0.4/0.5	4.0	
565 Vpk	890 Vpk	1140 Vpk	890 Vpk	1140 Vpk	565 Vpk	707 Vpk	707 Vpk	1140 Vpk /1230 Vpk	565 Vpk	890 Vpk /1130 Vpk	890 Vpk /1130 Vpk	
6000 Vpk	8000 Vpk	8000 Vpk	6000 Vpk /8000 Vpk	6000 Vpk /8000 Vpk	4000 Vpk /6000 Vpk	6000 Vpk	6000 Vpk	8000 Vpk	4000 Vpk	6000 Vpk /8000 Vpk	6000 Vpk /8000 Vpk	
TLP2403 TLP2404 TLP2405 TLP2408 TLP2409 TLP2418 TLP2451A TLP2466 TLP2468	TLP700 TLP700A TLP700H TLP701 TLP701A TLP701H TLP705A TLP708 TLP714 TLP715 TLP716 TLP718 TLP719 TLP2766 TLP2768	TLP700F TLP700AF TLP700HF TLP701F TLP701AF TLP701HF TLP705AF TLP708F TLP714F TLP715F TLP716F TLP718F TLP719F TLP2766F TLP2768F	TLP750 TLP751 TLP759 TLP350H TLP351H TLP352 TLP358 TLP358H TLPN137 TLP250H TLP351A TLP754 TLP2662 TLP2955 TLP2958 TLP2958F TLP2962	TLP750F TLP751F TLP759F TLP350HF TLP351HF TLP352F TLP358F TLP358HF TLP250HF TLP351AF TLP754F TLP2662F TLP2955F TLP2958F TLP2962F	TLP117 TLP2066 TLP2095 TLP2098		TLP109 TLP116A TLP104 TLP118 TLP151A TLP155 TLP155E TLP2309 TLP2345 TLP2348 TLP2355 TLP2358 TLP2362 TLP2366 TLP2368 TLP152 TLP2301 TLP2303 TLP2361 TLP2391 TLP2395 TLP2398	TLP2703 TLP2768A TLP5701 TLP5702 TLP5751 TLP5752 TLP5754				
			TLP620 TLP624 TLP626 TLP627 TLP628 TLP731 TLP732	TLP620F		TLP290(SE) TLP291(SE) TLP292 TLP293	TLP184(SE) TLP185(SE) TLP182 TLP183 TLP187 TLP188	TLP385	TLP290-4 TLP291-4 TLP292-4 TLP293-4	TLP733 TLP734 TLP785	TLP733F TLP734F TLP785F	
			TLP360J TLP361J TLP363J TLP3022(S) TLP3023(S) TLP3042(S) TLP3043(S) TLP3052(S) TLP3062(S) TLP3063(S) TLP3064(S) TLP3082(S) TLP3762(S) TLP3782(S) TLP3783(S) TLP663J(S) TLP665G(S) TLP665J(S) TLP666G(S) TLP666L(S) TLP668J(S) TLP669L(S)	TLP360JF TLP361JF TLP363JF TLP3022F(S) TLP3023F(S) TLP3042F(S) TLP3043F(S) TLP3052F(S) TLP3062F(S) TLP3063F(S) TLP3064F(S) TLP3082F(S) TLP3762F(S) TLP3782F(S) TLP3783F(S) TLP663JF(S) TLP665GF(S) TLP665JF(S) TLP666GF(S) TLP666LF(S) TLP668JF(S) TLP669LF(S)	TLP165J TLP166J		TLP265J TLP266J TLP267J TLP268J		TLP762J TLP763J TLP748J	TLP762JF TLP763JF TLP748JF		
			TLP797GA TLP797J	TLP797GAF TLP797JF			TLP175A TLP3905 TLP3906			TLP220A TLP220D TLP220G TLP220GA TLP220J TLP221A TLP240A TLP240D TLP240G TLP240GA TLP240J TLP241A	TLP220AF TLP220DF TLP220GF TLP220GAF TLP220JF TLP221AF TLP240AF TLP240DF TLP240GF TLP240GAF TLP240JF TLP241AF	

Toshiba America**Electronic Components, Inc.**

- Irvine, Headquarters
Tel: (949)462-7700 Fax: (949)462-2200
- Buffalo Grove (Chicago)
Tel: (847)484-2400 Fax: (847)541-7287
- Duluth/Atlanta
Tel: (770)931-3363 Fax: (770)931-7602
- El Paso
Tel: (915)533-4242
- Marlborough
Tel: (508)481-0034 Fax: (508)481-8828
- Parsippany
Tel: (973)541-4715 Fax: (973)541-4716
- San Jose
Tel: (408)526-2400 Fax: (408)526-2410
- Wixom (Detroit)
Tel: (248)347-2607 Fax: (248)347-2602

Toshiba Electronics do Brasil Ltda.

- Tel: (011)2936-6681 Fax: (011)2936-6675

Toshiba India Private Ltd.

- New Delhi Office
Tel: (0124)499-6600 Fax: (0124)499-6611
- Bangalore Office
Tel: (080)251-90800 Fax: (080)490-91945

Toshiba Electronics Europe GmbH

- Düsseldorf Head Office
Tel: (0211)5296-0 Fax: (0211)5296-400
- France Branch
Tel: (1)47282181
- Italy Branch
Tel: (039)68701 Fax: (039)6870205
- Munich Office
Tel: (089)20302030 Fax: (089)203020310
- Spain Branch
Tel: (91)660-6798 Fax: (91)660-6799
- Sweden Branch
Tel: (08)704-0900 Fax: (08)80-8459
- U.K. Branch
Tel: (1932)841600

Toshiba Vietnam Consumer Products Co.,Ltd.

- Tel: (043)776-5950 Fax: (043)776-5956

Toshiba Electronics Asia (Singapore) Pte. Ltd.

- Tel: (6278)5252 Fax: (6271)5155

Toshiba Electronics Service (Thailand) Co., Ltd.

- Tel: (02)835-3491 Fax: (02)835-3490

Toshiba Electronics Trading (Malaysia)Sdn. Bhd.

- Kuala Lumpur Head Office
Tel: (03)5631-6311 Fax: (03)5631-6307
- Penang Office
Tel: (04)226-8523 Fax: (04)226-8515

Toshiba Electronics (China) Co., Ltd.

- Shanghai Head Office
Tel: (021)6139-3888 Fax: (021)6190-8288
- Beijing Branch
Tel: (010)6590-8796 Fax: (010)6590-8791
- Chengdu Branch
Tel: (028)8675-1773 Fax: (028)8675-1065
- Hangzhou Office
Tel: (0571)8717-5004 Fax: (0571)8717-5013
- Nanjing Office
Tel: (025)8689-0070 Fax: (025)8689-0125
- Qingdao Branch
Tel: (532)8579-3328 Fax: (532)8579-3329
- Shenzhen Branch
Tel: (0755)3686-0880 Fax: (0755)3686-0816
- Dalian Branch
Tel: (0411)8368-6882 Fax: (0411)8369-0822
- Xiamen Branch
Tel: (0592)226-1398 Fax: (0592)226-1399
- Dongguan Branch
Tel: (0769)8155-6858 Fax: (0769)8155-6368
- Toshiba Electronics Asia, Ltd.
Tel: 2375-6111 Fax: 2375-0969
- Toshiba Electronics Korea Corporation
Tel: (02)3484-4334 Fax: (02)3484-4302
- Toshiba Electronics Taiwan Corporation
Tel: (02)2508-9988 Fax: (02)2508-9999

RESTRICTIONS ON PRODUCT USE

- ▶ Toshiba Corporation, and its subsidiaries and affiliates (collectively "TOSHIBA"), reserve the right to make changes to the information in this document, and related hardware, software and systems (collectively "Product") without notice.
- ▶ This document and any information herein may not be reproduced without prior written permission from TOSHIBA. Even with TOSHIBA's written permission, reproduction is permissible only if reproduction is without alteration/omission.
- ▶ Though TOSHIBA works continually to improve Product's quality and reliability, Product can malfunction or fail. Customers are responsible for complying with safety standards and for providing adequate designs and safeguards for their hardware, software and systems which minimize risk and avoid situations in which a malfunction or failure of Product could cause loss of human life, bodily injury or damage to property, including data loss or corruption. Before customers use the Product, create designs including the Product, or incorporate the Product into their own applications, customers must also refer to and comply with (a) the latest versions of all relevant TOSHIBA information, including without limitation, this document, the specifications, the data sheets and application notes for Product and the precautions and conditions set forth in the "TOSHIBA Semiconductor Reliability Handbook" and (b) the instructions for the application with which the Product will be used with or for. Customers are solely responsible for all aspects of their own product design or applications, including but not limited to (a) determining the appropriateness of the use of this Product in such design or applications; (b) evaluating and determining the applicability of any information contained in this document, or in charts, diagrams, programs, algorithms, sample application circuits, or any other referenced documents; and (c) validating all operating parameters for such designs and applications. **TOSHIBA ASSUMES NO LIABILITY FOR CUSTOMERS' PRODUCT DESIGN OR APPLICATIONS.**
- ▶ **PRODUCT IS NEITHER INTENDED NOR WARRANTED FOR USE IN EQUIPMENTS OR SYSTEMS THAT REQUIRE EXTRAORDINARILY HIGH LEVELS OF QUALITY AND/OR RELIABILITY, AND/OR A MALFUNCTION OR FAILURE OF WHICH MAY CAUSE LOSS OF HUMAN LIFE, BODILY INJURY, SERIOUS PROPERTY DAMAGE AND/OR SERIOUS PUBLIC IMPACT ("UNINTENDED USE").** Except for specific applications as expressly stated in this document, Unintended Use includes, without limitation, equipment used in nuclear facilities, equipment used in the aerospace industry, medical equipment, equipment used for automobiles, trains, ships and other transportation, traffic signaling equipment, equipment used to control combustions or explosions, safety devices, elevators and escalators, devices related to electric power, and equipment used in finance-related fields. **IF YOU USE PRODUCT FOR UNINTENDED USE, TOSHIBA ASSUMES NO LIABILITY FOR PRODUCT.** For details, please contact your TOSHIBA sales representative.
- ▶ Do not disassemble, analyze, reverse-engineer, alter, modify, translate or copy Product, whether in whole or in part.
- ▶ Product shall not be used for or incorporated into any products or systems whose manufacture, use, or sale is prohibited under any applicable laws or regulations.
- ▶ The information contained herein is presented only as guidance for Product use. No responsibility is assumed by TOSHIBA for any infringement of patents or any other intellectual property rights of third parties that may result from the use of Product. No license to any intellectual property right is granted by this document, whether express or implied, by estoppel or otherwise.
- ▶ **ABSENT A WRITTEN SIGNED AGREEMENT, EXCEPT AS PROVIDED IN THE RELEVANT TERMS AND CONDITIONS OF SALE FOR PRODUCT, AND TO THE MAXIMUM EXTENT ALLOWABLE BY LAW, TOSHIBA (1) ASSUMES NO LIABILITY WHATSOEVER, INCLUDING WITHOUT LIMITATION, INDIRECT, CONSEQUENTIAL, SPECIAL, OR INCIDENTAL DAMAGES OR LOSS, INCLUDING WITHOUT LIMITATION, LOSS OF PROFITS, LOSS OF OPPORTUNITIES, BUSINESS INTERRUPTION AND LOSS OF DATA, AND (2) DISCLAIMS ANY AND ALL EXPRESS OR IMPLIED WARRANTIES AND CONDITIONS RELATED TO SALE, USE OF PRODUCT, OR INFORMATION, INCLUDING WARRANTIES OR CONDITIONS OF MERCHANTABILITY, FITNESS FOR A PARTICULAR PURPOSE, ACCURACY OF INFORMATION, OR NONINFRINGEMENT.**
- ▶ GaAs (Gallium Arsenide) is used in Product. GaAs is harmful to humans if consumed or absorbed, whether in the form of dust or vapor. Handle with care and do not break, cut, crush, grind, dissolve chemically or otherwise expose GaAs in Product.
- ▶ Do not use or otherwise make available Product or related software or technology for any military purposes, including without limitation, for the design, development, use, stockpiling or manufacturing of nuclear, chemical, or biological weapons or missile technology products (mass destruction weapons). Product and related software and technology may be controlled under the applicable export laws and regulations including, without limitation, the Japanese Foreign Exchange and Foreign Trade Law and the U.S. Export Administration Regulations. Export and re-export of Product or related software or technology are strictly prohibited except in compliance with all applicable export laws and regulations.
- ▶ Please contact your TOSHIBA sales representative for details as to environmental matters such as the RoHS compatibility of Product. Please use Product in compliance with all applicable laws and regulations that regulate the inclusion or use of controlled substances, including without limitation, the EU RoHS Directive. **TOSHIBA ASSUMES NO LIABILITY FOR DAMAGES OR LOSSES OCCURRING AS A RESULT OF NONCOMPLIANCE WITH APPLICABLE LAWS AND REGULATIONS.**

TOSHIBA**TOSHIBA CORPORATION**

Semiconductor & Storage Products Company

Website: <http://toshiba.semicon-storage.com/>

Mouser Electronics

Authorized Distributor

Click to View Pricing, Inventory, Delivery & Lifecycle Information:

[Toshiba:](#)

[TLP385\(D4-TPR,E](#)