

# Single-Channel, Power-Distribution Switch EVM

---



---



---

This user's guide describes the TPS20xxEVM-290 and TPS20xxEVM-292 evaluation modules (EVM). This guide contains the EVM schematics, bill of materials, assembly drawings, and top and bottom board layouts.

### Contents

1	Introduction .....	2
2	Schematics and Bill of Materials .....	2
	2.1 EVM Options .....	2
	2.2 Schematics .....	3
	2.3 Bill of Material .....	5
3	Board Layout .....	7
	3.1 TPS20xxEVM-290 Board .....	7
	3.2 TPS20xxEVM-292 Board .....	9
	3.3 Layout Considerations .....	10
4	EVM Setup .....	10
	4.1 Recommended Test Equipment .....	10
	4.2 Measuring Current Limit .....	10
5	Related Documentation from Texas Instruments .....	11

### List of Figures

1	TPS20xxEVM-290 Schematic .....	3
2	TPS20xxEVM-292 Schematic .....	4
3	TPS20xxEVM-290 Component Placement .....	7
4	TPS20xxEVM-290 Top-Side Layout .....	8
5	TPS20xxEVM-290 Bottom-Side Layout .....	8
6	TPS20xxEVM-292 Component Placement .....	9
7	TPS20xxEVM-292 Top-Side Layout .....	9
8	TPS20xxEVM-292 Bottom-Side Layout .....	10
9	EVM Setup For Measuring Current Limit .....	11
10	TPS2051BEVM-290 Short-Circuit Output Current and $\overline{OC}$ Status .....	11

### List of Tables

1	TPS20xxEVM-290 Options .....	2
2	TPS20xxEVM-292 Options .....	2
3	TPS20xxEVM-290 Bill of Materials .....	5
4	TPS20xxEVM-292 Bill of Materials .....	7

## 1 Introduction

The TPS20xxEVM-290 and TPS20xxEVM-292 are evaluation modules (EVM) for the Texas Instruments family of single-channel, current-limited, power distribution switches. These EVMs operate over a 2.7-V to 5.5-V range and provide a continuous output current of up to 2 A (see [Table 1](#)). Test points provide convenient access to all critical node voltages.

The TPS20xxEVM-290 accepts an S0-8 packaged power-distribution switch whereas the TPS20xxEVM-292 accepts MSOP-8 packaged switch with a thermal pad. These switches have an enable input, an overcurrent status output, and overtemperature shutdown; the switch pinouts are identical.

[Table 1](#) and [Table 2](#) summarize the available EVM options.

## 2 Schematics and Bill of Materials

### 2.1 EVM Options

**Table 1. TPS20xxEVM-290 Options**

EVM	Device	Continuous Output Current (A)	ENABLE
TPS2020EVM-290	TPS2020D	0.2	Active Low
TPS2021EVM-290	TPS2021D	0.6	Active Low
TPS2022EVM-290	TPS2022D	1	Active Low
TPS2023EVM-290	TPS2023D	1.5	Active Low
TPS2024EVM-290	TPS2024D	2	Active Low
TPS2030EVM-290	TPS2030D	0.2	Active High
TPS2031EVM-290	TPS2031D	0.6	Active High
TPS2032EVM-290	TPS2032D	1	Active High
TPS2033EVM-290	TPS2033D	1.5	Active High
TPS2034EVM-290	TPS2034D	2	Active High
TPS2041BEVM-290	TPS2041BD	0.5	Active Low
TPS2045AEVM-290	TPS2045AD	0.25	Active Low
TPS2049EVM-290	TPS2049D	0.1	Active Low
TPS2051BEVM-290	TPS2051BD	0.5	Active High
TPS2055AEVM-290	TPS2055AD	0.25	Active High
TPS2061EVM-290	TPS2061D	1	Active Low
TPS2065EVM-290	TPS2065D	1	Active High

**Table 2. TPS20xxEVM-292 Options**

EVM	Device	Continuous Output Current (A)	ENABLE
TPS2041BEVM-292	TPS2041BDGN	0.5	Active Low
TPS2051BEVM-292	TPS2051BDGN	0.5	Active High
TPS2061EVM-292	TPS2061DGN	1	Active Low
TPS2065EVM-292	TPS2065DGN	1	Active High
TPS2065-1EVM-292	TPS2065DGN-1	1	Active High
TPS2068EVM-292	TPS2068DGN	1.5	Active Low
TPS2069EVM-292	TPS2069DGN	1.5	Active High

## 2.2 Schematics

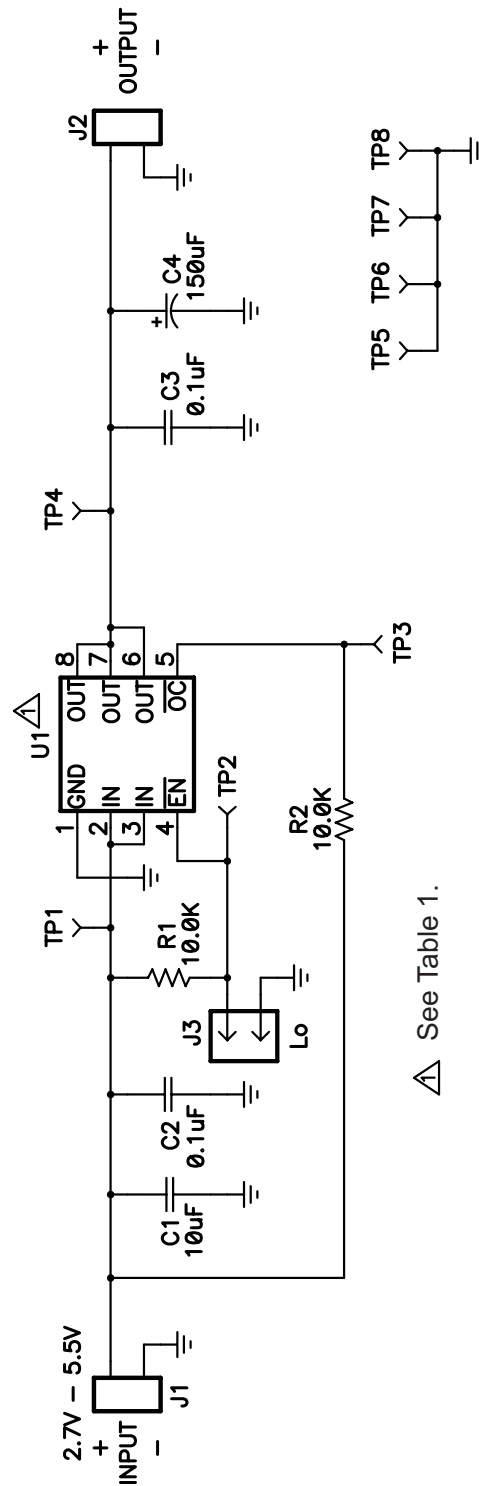

Figure 1. TPS20xxEVM-290 Schematic



**2.3 Bill of Material**

**Table 3. TPS20xxEVM-290 Bill of Materials**

QTY																	Ref Des	Value	Description	Size	Part No.	MFR
-001	-002	-003	-004	-005	-006	-007	-008	-009	-010	-011	-012	-013	-014	-015	-016	-017						
1	1	1	1	1	1	1	1	1	1	1	1	1	1	1	1	1	C1	10uF	Capacitor, Ceramic, 10-µF, X7R, 10V, 10%	1206	STD	STD
2	2	2	2	2	2	2	2	2	2	2	2	2	2	2	2	2	C2, C3	0.1uF	Capacitor, Ceramic, 16V, X7R, 10%	0805	STD	STD
1	1	1	1	1	1	1	1	1	1	1	1	1	1	1	1	1	C4	150uF	Capacitor, Tantalum, 150µF, 10V, 100milliohm, 10%	7343 (D)	B45197A2157K409	Kemet
1	0	0	0	0	0	0	0	0	0	0	0	0	0	0	0	0	U1	TPS2020D	IC, Current-Limited Power Distribution Switch, 5.5V, 200mA	SO8	TPS2020D	TI
0	1	0	0	0	0	0	0	0	0	0	0	0	0	0	0	0	U1	TPS2021D	IC, Current-Limited Power Distribution Switch, 5.5V, 600mA	SO8	TPS2021D	TI
0	0	1	0	0	0	0	0	0	0	0	0	0	0	0	0	0	U1	TPS2022D	IC, Current-Limited Power Distribution Switch, 5.5V, 1000mA	SO8	TPS2022D	TI
0	0	0	1	0	0	0	0	0	0	0	0	0	0	0	0	0	U1	TPS2023D	IC, Current-Limited Power Distribution Switch, 5.5V, 1500mA	SO8	TPS2023D	TI
0	0	0	0	1	0	0	0	0	0	0	0	0	0	0	0	0	U1	TPS2024D	IC, Current-Limited Power Distribution Switch, 5.5V, 2000mA	SO8	TPS2024D	TI
0	0	0	0	0	1	0	0	0	0	0	0	0	0	0	0	0	U1	TPS2030D	IC, Current-Limited Power Distribution Switch, 5.5V, 200mA	SO8	TPS2030D	TI
0	0	0	0	0	0	1	0	0	0	0	0	0	0	0	0	0	U1	TPS2031D	IC, Current-Limited Power Distribution Switch, 5.5V, 600mA	SO8	TPS2031D	TI
0	0	0	0	0	0	0	1	0	0	0	0	0	0	0	0	0	U1	TPS2032D	IC, Current-Limited Power Distribution Switch, 5.5V, 1000mA	SO8	TPS2032D	TI
0	0	0	0	0	0	0	0	1	0	0	0	0	0	0	0	0	U1	TPS2033D	IC, Current-Limited Power Distribution Switch, 5.5V, 1500mA	SO8	TPS2033D	TI
0	0	0	0	0	0	0	0	0	1	0	0	0	0	0	0	0	U1	TPS2034D	IC, Current-Limited Power Distribution Switch, 5.5V, 2000mA	SO8	TPS2034D	TI
0	0	0	0	0	0	0	0	0	0	1	0	0	0	0	0	0	U1	TPS2041BD	IC, Current-Limited Power Distribution Switch, 5.5V, 500mA	SO8	TPS2041BD	TI
0	0	0	0	0	0	0	0	0	0	0	1	0	0	0	0	0	U1	TPS2045AD	IC, Current-Limited Power Distribution Switch, 5.5V, 250mA	SO8	TPS2045AD	TI
0	0	0	0	0	0	0	0	0	0	0	0	1	0	0	0	0	U1	TPS2049D	IC, Current-Limited Power Distribution Switch, 5.5V, 100mA	SO8	TPS2049D	TI

**Table 3. TPS20xxEVM-290 Bill of Materials (continued)**

QTY																	Ref Des	Value	Description	Size	Part No.	MFR
-001	-002	-003	-004	-005	-006	-007	-008	-009	-010	-011	-012	-013	-014	-015	-016	-017						
0	0	0	0	0	0	0	0	0	0	0	0	0	1	0	0	0	U1	TPS2051BD	IC, Current-Limited Power Distribution Switch, 5.5V, 500mA	SO8	TPS2051BD	TI
0	0	0	0	0	0	0	0	0	0	0	0	0	0	1	0	0	U1	TPS2055AD	IC, Current-Limited Power Distribution Switch, 5.5V, 250mA	SO8	TPS2055AD	TI
0	0	0	0	0	0	0	0	0	0	0	0	0	0	0	1	0	U1	TPS2061D	IC, Current-Limited Power Distribution Switch, 5.5V, 1500mA	SO8	TPS2061D	TI
0	0	0	0	0	0	0	0	0	0	0	0	0	0	0	0	1	U1	TPS2065D	IC, Current-Limited Power Distribution Switch, 5.5V, 1500mA	SO8	TPS2065D	TI
1	1	1	1	1	1	1	1	1	1	1	1	1	1	1	1	1	--	HPA290	PCB, 3 ln x 3 ln x 0.062 ln	2.25 inch x 2.225 inch	HPA290	Any
2	2	2	2	2	2	2	2	2	2	2	2	2	2	2	2	2	R1, R2	10.0K	Resistor, Chip, 1/10W, 1%	0805	CRCW0805-1002F	Vishay

**Table 4. TPS20xxEVM-292 Bill of Materials**

QTY							RefDes	Value	Description	Size	Part Number	MFR
-001	-002	-003	-004	-005	-006	-007						
1	1	1	1	1	1	1	C1	10uF	Capacitor, ceramic, 10-μF, X7R, 10V, 10%	1206	STD	STD
2	2	2	2	2	2	2	C2, C3	0.1uF	Capacitor, Ceramic, 16V, X7R, 10%	0805	STD	STD
1	1	1	1	1	1	1	C4	150uF	Capacitor, Tantalum, 150μF, 10V, 100mΩ, 10%	7343 (D)	B45197A2157K409	Kemet
1	0	0	0	0	0	0	U1	TPS2041BDGN	IC, Current-Limited Power Distribution Switch, 5.5V, 500mA	MSOP-8	TPS2041BDGN	TI
0	1	0	0	0	0	0	U1	TPS2051BDGN	IC, Current-Limited Power Distribution Switch, 5.5V, 500mA	MSOP-8	TPS2051BDGN	TI
0	0	1	0	0	0	0	U1	TPS2061DGN	IC, Current-Limited Power Distribution Switch, 5.5V, 1000mA	MSOP-8	TPS2061DGN	TI
0	0	0	1	0	0	0	U1	TPS2065DGN	IC, Current-Limited Power Distribution Switch, 5.5V, 1000mA	MSOP-8	TPS2065DGN	TI
0	0	0	0	1	0	0	U1	TPS2065DGN-1	IC, Current-Limited Power Distribution Switch, 5.5V, 1000mA	MSOP-8	TPS2065DGN-1	TI
0	0	0	0	0	1	0	U1	TPS2068DGN	IC, Current-Limited Power Distribution Switch, 5.5V, 1500mA	MSOP-8	TPS2068DGN	TI
0	0	0	0	0	0	1	U1	TPS2069DGN	IC, Current-Limited Power Distribution Switch, 5.5V, 1500mA	MSOP-8	TPS2069DGN	TI
1	1	1	1	1	1	1	--	HPA292	PCB, 3 In x 3 In x 0.062 In	2.25" x 2.225"	HPA292	Any
2	2	2	2	2	2	2	R1, R2	10.0K	Resistor, Chip, 1/10W, 1%	0805	CRCW0805-1002F	Vishay

### 3 Board Layout

This section contains three views of the TPS20xxEVM-290 and the TPS20xxEVM-292 evaluation boards as well as some layout considerations.

#### 3.1 TPS20xxEVM-290 Board

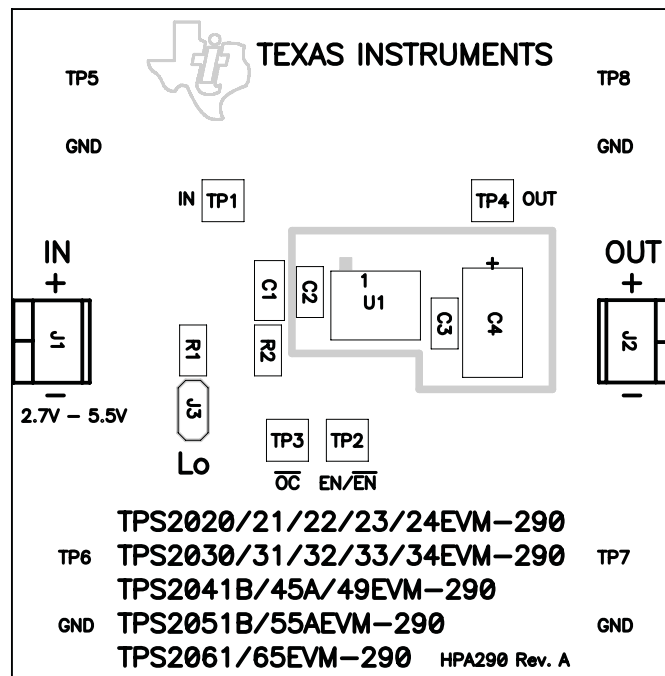

**Figure 3. TPS20xxEVM-290 Component Placement**

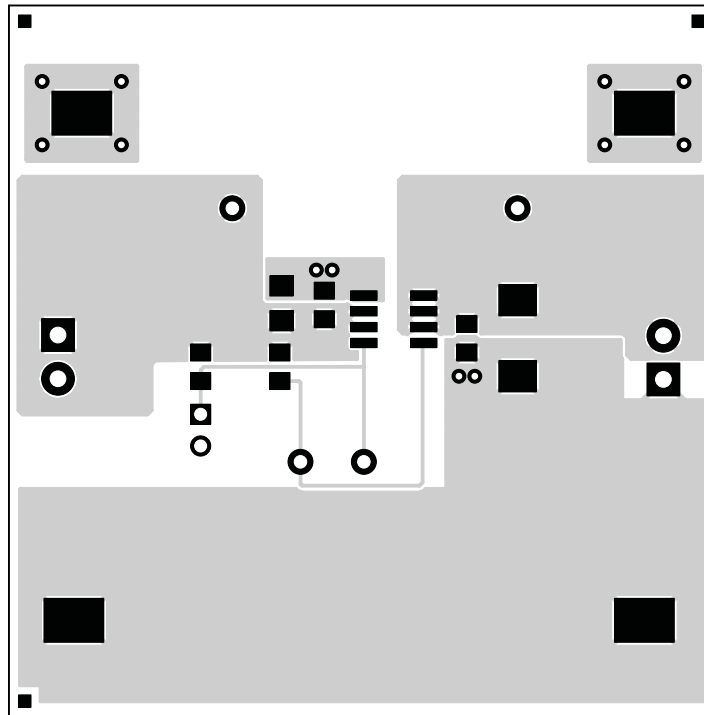

**Figure 4. TPS20xxEVM-290 Top-Side Layout**

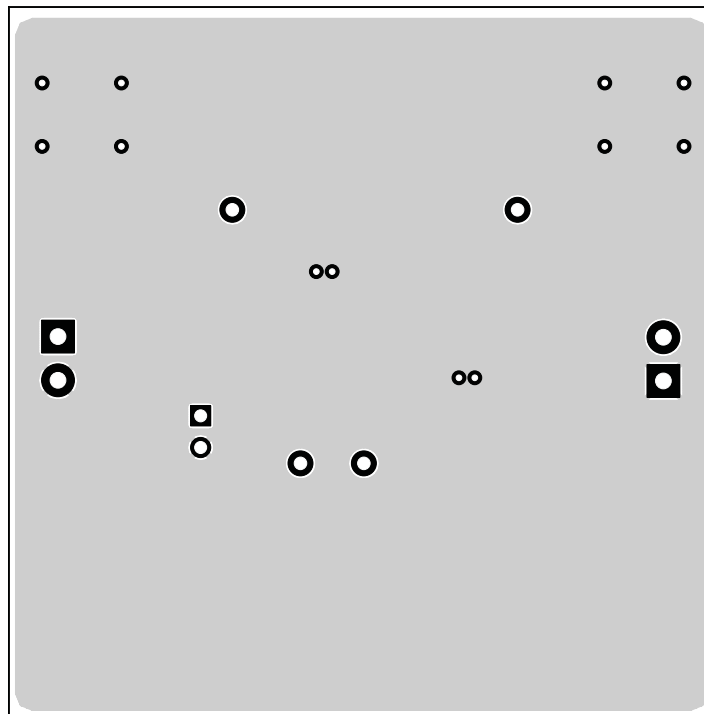

**Figure 5. TPS20xxEVM-290 Bottom-Side Layout**



### 3.2 TPS20xxEVM-292 Board

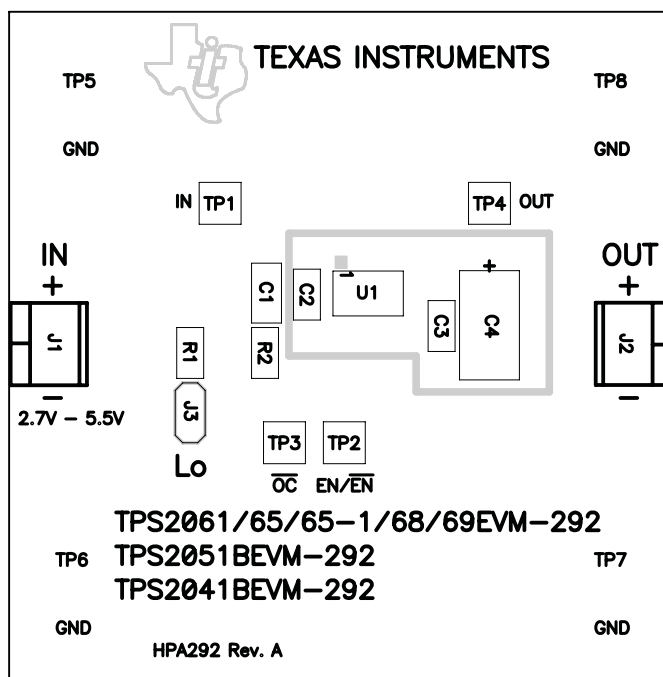

Figure 6. TPS20xxEVM-292 Component Placement

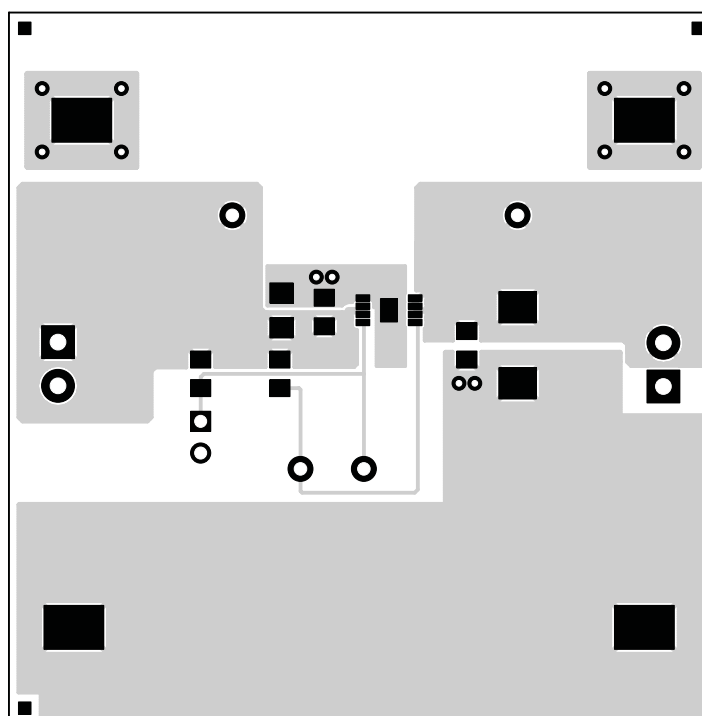
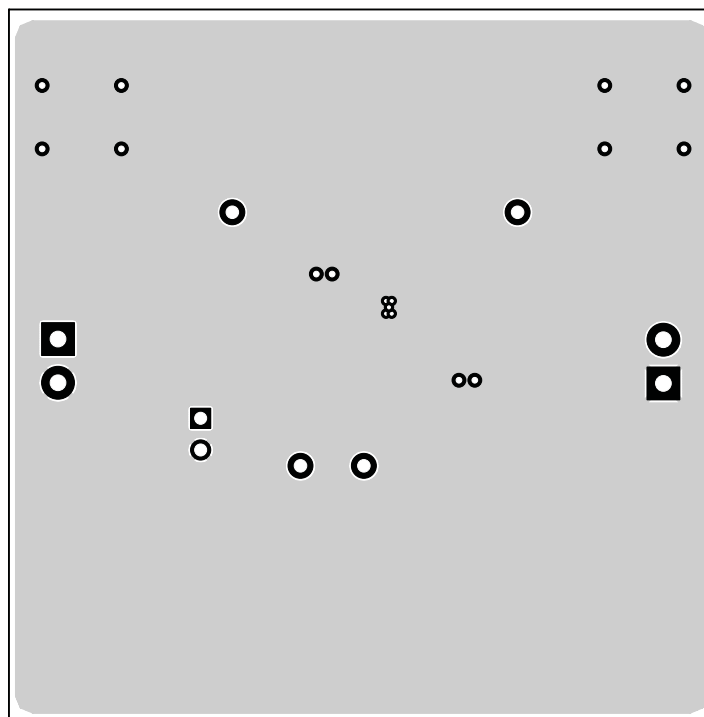

Figure 7. TPS20xxEVM-292 Top-Side Layout



**Figure 8. TPS20xxEVM-292 Bottom-Side Layout**

### 3.3 *Layout Considerations*

The IN and OUT pins of U1 can carry significant current; so, traces to these pins should be of suitable length and width to minimize the voltage drop to the load. Locate the 0.1- $\mu$ F bypass capacitors close to the IN and OUT pins of U1.

## 4 **EVM Setup**

### 4.1 *Recommended Test Equipment*

The following test equipment is recommended:

- Two-channel storage oscilloscope
- Current probe
- Voltage probe
- 5 V at 5-A power supply
- Volt-ohm meter
- A passive or active load

### 4.2 *Measuring Current Limit*

The user should read the applicable data sheet before using the EVM.

[Figure 9](#) shows the EVM test set up for measuring current limit. The power distribution switch is enabled into a short circuit for this measurement. [Figure 10](#) shows the current waveform for TPS2051BEVM-290.

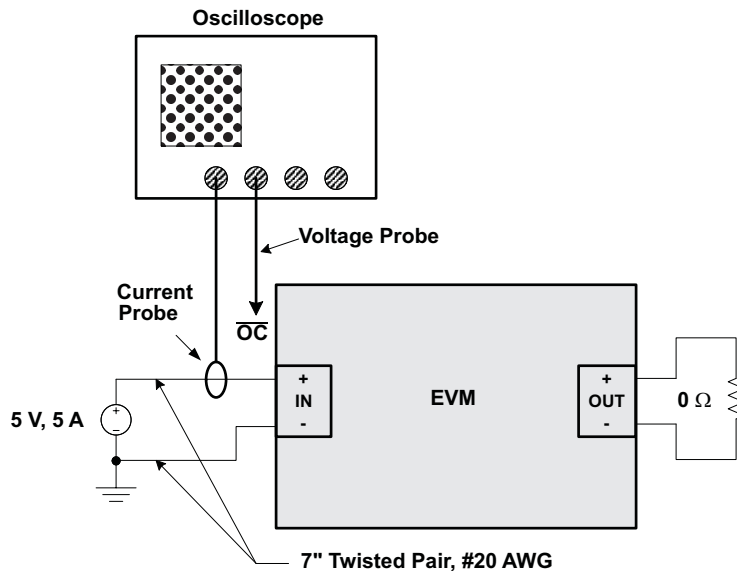

Figure 9. EVM Setup For Measuring Current Limit

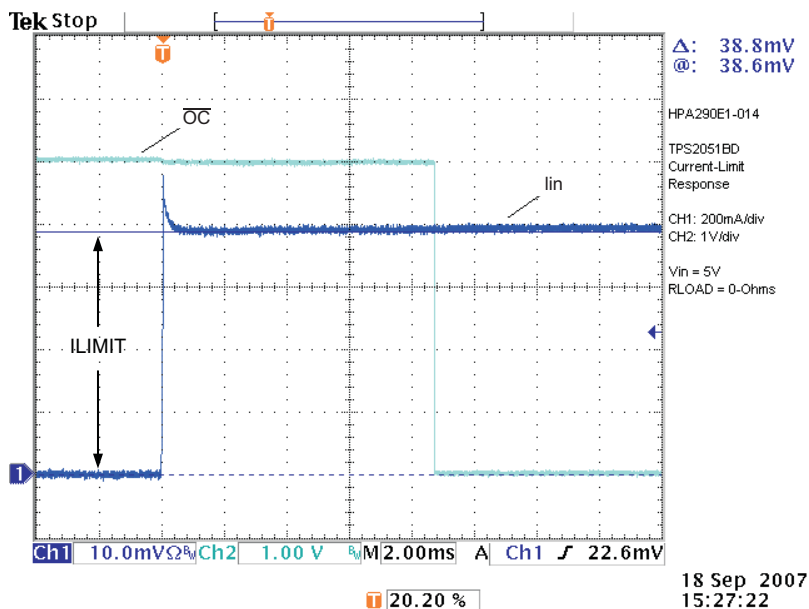

Figure 10. TPS2051BEVM-290 Short-Circuit Output Current and  $\overline{OC}$  Status

## 5 Related Documentation from Texas Instruments

- *TPS2020, TPS2021, TPS2022, TPS2023, TPS2024, Power-Distribution Switches* data sheet ([SLVS175](#))
- *TPS2030, TPS2031, TPS2032, TPS2033, TPS2034, Power-Distribution Switches* data sheet ([SLVS190](#))
- *TPS2041B, TPS2042B, TPS2043B, TPS2044B, TPS2051B, TPS2052B, TPS2053B, TPS2054B, Current-Limited, Power-Distribution Switches* data sheet ([SLVS514](#))
- *TPS2045A, TPS2046A, TPS2047A, TPS2056A, TPS2057A, TPS2058A, Current-Limited, Power-Distribution Switches* data sheet ([SLVS251](#))
- *TPS2049, Single-Channel 100 mA Power Switch* data sheet ([SLVS713](#))

*Related Documentation from Texas Instruments*

---

- *TPS2061, TPS2062, TPS2063, TPS2065, TPS2066, TPS2067, Current-Limited, Power-Distribution Switches* data sheet ([SLVS490](#))
- *TPS2061-1, TPS2065-1, TPS2066-1, Current-Limited, Power-Distribution Switches* data sheet ([SLVS714](#))
- *TPS2060, TPS2064, TPS2068, TPS2069, Current-Limited, Power-Distribution Switches* data sheet ([SLVS553](#))

## EVALUATION BOARD/KIT IMPORTANT NOTICE

Texas Instruments (TI) provides the enclosed product(s) under the following conditions:

This evaluation board/kit is intended for use for **ENGINEERING DEVELOPMENT, DEMONSTRATION, OR EVALUATION PURPOSES ONLY** and is not considered by TI to be a finished end-product fit for general consumer use. Persons handling the product(s) must have electronics training and observe good engineering practice standards. As such, the goods being provided are not intended to be complete in terms of required design-, marketing-, and/or manufacturing-related protective considerations, including product safety and environmental measures typically found in end products that incorporate such semiconductor components or circuit boards. This evaluation board/kit does not fall within the scope of the European Union directives regarding electromagnetic compatibility, restricted substances (RoHS), recycling (WEEE), FCC, CE or UL, and therefore may not meet the technical requirements of these directives or other related directives.

Should this evaluation board/kit not meet the specifications indicated in the User's Guide, the board/kit may be returned within 30 days from the date of delivery for a full refund. **THE FOREGOING WARRANTY IS THE EXCLUSIVE WARRANTY MADE BY SELLER TO BUYER AND IS IN LIEU OF ALL OTHER WARRANTIES, EXPRESSED, IMPLIED, OR STATUTORY, INCLUDING ANY WARRANTY OF MERCHANTABILITY OR FITNESS FOR ANY PARTICULAR PURPOSE.**

The user assumes all responsibility and liability for proper and safe handling of the goods. Further, the user indemnifies TI from all claims arising from the handling or use of the goods. Due to the open construction of the product, it is the user's responsibility to take any and all appropriate precautions with regard to electrostatic discharge.

**EXCEPT TO THE EXTENT OF THE INDEMNITY SET FORTH ABOVE, NEITHER PARTY SHALL BE LIABLE TO THE OTHER FOR ANY INDIRECT, SPECIAL, INCIDENTAL, OR CONSEQUENTIAL DAMAGES.**

TI currently deals with a variety of customers for products, and therefore our arrangement with the user **is not exclusive.**

TI assumes **no liability for applications assistance, customer product design, software performance, or infringement of patents or services described herein.**

Please read the User's Guide and, specifically, the Warnings and Restrictions notice in the User's Guide prior to handling the product. This notice contains important safety information about temperatures and voltages. For additional information on TI's environmental and/or safety programs, please contact the TI application engineer or visit [www.ti.com/esh](http://www.ti.com/esh).

No license is granted under any patent right or other intellectual property right of TI covering or relating to any machine, process, or combination in which such TI products or services might be or are used.

### FCC Warning

This evaluation board/kit is intended for use for **ENGINEERING DEVELOPMENT, DEMONSTRATION, OR EVALUATION PURPOSES ONLY** and is not considered by TI to be a finished end-product fit for general consumer use. It generates, uses, and can radiate radio frequency energy and has not been tested for compliance with the limits of computing devices pursuant to part 15 of FCC rules, which are designed to provide reasonable protection against radio frequency interference. Operation of this equipment in other environments may cause interference with radio communications, in which case the user at his own expense will be required to take whatever measures may be required to correct this interference.

### EVM WARNINGS AND RESTRICTIONS

It is important to operate this EVM within the input voltage range of 2.7 V to 5.5 V and the output voltage range of 2.7 V to 5.5 V.

Exceeding the specified input range may cause unexpected operation and/or irreversible damage to the EVM. If there are questions concerning the input range, please contact a TI field representative prior to connecting the input power.

Applying loads outside of the specified output range may result in unintended operation and/or possible permanent damage to the EVM. Please consult the EVM User's Guide prior to connecting any load to the EVM output. If there is uncertainty as to the load specification, please contact a TI field representative.

During normal operation, some circuit components may have case temperatures greater than 85°C. The EVM is designed to operate properly with certain components above 85°C as long as the input and output ranges are maintained. These components include but are not limited to linear regulators, switching transistors, pass transistors, and current sense resistors. These types of devices can be identified using the EVM schematic located in the EVM User's Guide. When placing measurement probes near these devices during operation, please be aware that these devices may be very warm to the touch.

Mailing Address: Texas Instruments, Post Office Box 655303, Dallas, Texas 75265  
Copyright © 2007, Texas Instruments Incorporated

## IMPORTANT NOTICE

Texas Instruments Incorporated and its subsidiaries (TI) reserve the right to make corrections, modifications, enhancements, improvements, and other changes to its products and services at any time and to discontinue any product or service without notice. Customers should obtain the latest relevant information before placing orders and should verify that such information is current and complete. All products are sold subject to TI's terms and conditions of sale supplied at the time of order acknowledgment.

TI warrants performance of its hardware products to the specifications applicable at the time of sale in accordance with TI's standard warranty. Testing and other quality control techniques are used to the extent TI deems necessary to support this warranty. Except where mandated by government requirements, testing of all parameters of each product is not necessarily performed.

TI assumes no liability for applications assistance or customer product design. Customers are responsible for their products and applications using TI components. To minimize the risks associated with customer products and applications, customers should provide adequate design and operating safeguards.

TI does not warrant or represent that any license, either express or implied, is granted under any TI patent right, copyright, mask work right, or other TI intellectual property right relating to any combination, machine, or process in which TI products or services are used. Information published by TI regarding third-party products or services does not constitute a license from TI to use such products or services or a warranty or endorsement thereof. Use of such information may require a license from a third party under the patents or other intellectual property of the third party, or a license from TI under the patents or other intellectual property of TI.

Reproduction of TI information in TI data books or data sheets is permissible only if reproduction is without alteration and is accompanied by all associated warranties, conditions, limitations, and notices. Reproduction of this information with alteration is an unfair and deceptive business practice. TI is not responsible or liable for such altered documentation. Information of third parties may be subject to additional restrictions.

Resale of TI products or services with statements different from or beyond the parameters stated by TI for that product or service voids all express and any implied warranties for the associated TI product or service and is an unfair and deceptive business practice. TI is not responsible or liable for any such statements.

TI products are not authorized for use in safety-critical applications (such as life support) where a failure of the TI product would reasonably be expected to cause severe personal injury or death, unless officers of the parties have executed an agreement specifically governing such use. Buyers represent that they have all necessary expertise in the safety and regulatory ramifications of their applications, and acknowledge and agree that they are solely responsible for all legal, regulatory and safety-related requirements concerning their products and any use of TI products in such safety-critical applications, notwithstanding any applications-related information or support that may be provided by TI. Further, Buyers must fully indemnify TI and its representatives against any damages arising out of the use of TI products in such safety-critical applications.

TI products are neither designed nor intended for use in military/aerospace applications or environments unless the TI products are specifically designated by TI as military-grade or "enhanced plastic." Only products designated by TI as military-grade meet military specifications. Buyers acknowledge and agree that any such use of TI products which TI has not designated as military-grade is solely at the Buyer's risk, and that they are solely responsible for compliance with all legal and regulatory requirements in connection with such use.

TI products are neither designed nor intended for use in automotive applications or environments unless the specific TI products are designated by TI as compliant with ISO/TS 16949 requirements. Buyers acknowledge and agree that, if they use any non-designated products in automotive applications, TI will not be responsible for any failure to meet such requirements.

Following are URLs where you can obtain information on other Texas Instruments products and application solutions:

<b>Products</b>		<b>Applications</b>	
Amplifiers	<a href="http://amplifier.ti.com">amplifier.ti.com</a>	Audio	<a href="http://www.ti.com/audio">www.ti.com/audio</a>
Data Converters	<a href="http://dataconverter.ti.com">dataconverter.ti.com</a>	Automotive	<a href="http://www.ti.com/automotive">www.ti.com/automotive</a>
DSP	<a href="http://dsp.ti.com">dsp.ti.com</a>	Broadband	<a href="http://www.ti.com/broadband">www.ti.com/broadband</a>
Interface	<a href="http://interface.ti.com">interface.ti.com</a>	Digital Control	<a href="http://www.ti.com/digitalcontrol">www.ti.com/digitalcontrol</a>
Logic	<a href="http://logic.ti.com">logic.ti.com</a>	Military	<a href="http://www.ti.com/military">www.ti.com/military</a>
Power Mgmt	<a href="http://power.ti.com">power.ti.com</a>	Optical Networking	<a href="http://www.ti.com/opticalnetwork">www.ti.com/opticalnetwork</a>
Microcontrollers	<a href="http://microcontroller.ti.com">microcontroller.ti.com</a>	Security	<a href="http://www.ti.com/security">www.ti.com/security</a>
RFID	<a href="http://www.ti-rfid.com">www.ti-rfid.com</a>	Telephony	<a href="http://www.ti.com/telephony">www.ti.com/telephony</a>
Low Power Wireless	<a href="http://www.ti.com/lpw">www.ti.com/lpw</a>	Video & Imaging	<a href="http://www.ti.com/video">www.ti.com/video</a>
		Wireless	<a href="http://www.ti.com/wireless">www.ti.com/wireless</a>

Mailing Address: Texas Instruments, Post Office Box 655303, Dallas, Texas 75265  
Copyright © 2007, Texas Instruments Incorporated

# Mouser Electronics

Authorized Distributor

Click to View Pricing, Inventory, Delivery & Lifecycle Information:

## Texas Instruments:

[TPS2033EVM-290](#) [TPS2051BEVM-292](#) [TPS2041BEVM-292](#) [TPS2061EVM-290](#) [TPS2051BEVM-290](#)  
[TPS2061EVM-292](#) [TPS2023EVM-290](#) [TPS2030EVM-290](#) [TPS2031EVM-290](#) [TPS2032EVM-290](#) [TPS2024EVM-290](#)  
[TPS2034EVM-290](#) [TPS2022EVM-290](#) [TPS2020EVM-290](#) [TPS2065EVM-290](#) [TPS2055AEVM-290](#) [TPS2045AEVM-](#)  
[290](#) [TPS2069EVM-292](#) [TPS2041BEVM-290](#) [TPS2049EVM-290](#) [TPS2021EVM-290](#) [TPS2065EVM-292](#) [TPS2065-](#)  
[1EVM-292](#)