

## DS9637A Dual Differential Line Receiver

Check for Samples: [DS9637A](#)

### FEATURES

- Dual Channel
- Single 5V Supply
- Satisfies EIA Standards RS-422 and RS423
- Built-in  $\pm 35$  mV Hysteresis
- High Input Common Mode Voltage Range
- High Input impedance
- TTL Compatible Outputs
- Schottky Technology
- Extended Temperature Range

### DESCRIPTION

The DS9637A is a Schottky dual differential line receiver which has been specifically designed to satisfy the requirements of EIA Standards RS-422 and RS-423. In addition, the DS9637A satisfies the requirements of MIL-STD 188-114 and is compatible with the International Standard CCITT recommendations. The DS9637A is suitable for use as a line receiver in digital data systems, using either single ended or differential, unipolar or bipolar transmission. It requires a single 5V power supply and has Schottky TTL compatible outputs. The DS9637A has an operational input common mode range of  $\pm 7V$  either differentially or to ground.

### Connection Diagram

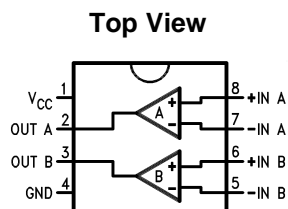

**Figure 1. 8-Lead SOIC (D Package)  
8-Lead PDIP (P Package)  
For Complete Military Product Specifications,  
refer to the appropriate SMD or MDS.  
8-Lead CDIP (NAB Package)**



Please be aware that an important notice concerning availability, standard warranty, and use in critical applications of Texas Instruments semiconductor products and disclaimers thereto appears at the end of this data sheet.

All trademarks are the property of their respective owners.



These devices have limited built-in ESD protection. The leads should be shorted together or the device placed in conductive foam during storage or handling to prevent electrostatic damage to the MOS gates.

### Absolute Maximum Ratings<sup>(1)(2)</sup>

Storage Temperature Range	
CDIP	-65°C to + 175°C
PDIP	-65°C to + 150°C
Lead Temperature CDIP (Soldering, 30 seconds)	300°C
PDIP and SOIC Packages (Soldering, 10 seconds)	265°C
Maximum Power Dissipation <sup>(3)</sup> at 25°C	
CDIP	1300 mW
PDIP	930 mW
SOIC	810 mW
V <sub>CC</sub> Lead Potential to Ground	-0.5V to 7.0V
Input Potential to Ground	±15V
Differential Input Voltage	±15V
Output Potential to Ground	-0.5V to +5.5V
Output Sink Current	50 mA
ESD Susceptibility, HBM	≥2 kV

- (1) Absolute Maximum Ratings are those values beyond which the safety of the device cannot be ensured. They are not meant to imply that the devices should be operated at these limits. The tables of ["Electrical Characteristics"](#) provide conditions for actual device operation.
- (2) If Military/Aerospace specified devices are required, please contact the Texas Instruments Sales Office/ Distributors for availability and specifications.
- (3) Derate CDIP 8.7 mW/°C above 25°C; derate PDIP 7.5 mW/°C above 25°C; derate SOIC package 6.5 mW/°C above 25°C.

### Recommended Operating Conditions

DS9637AM	Min	Max	Units
Supply Voltage (V <sub>CC</sub> )	4.5	5.5	V
Operating Temperature (T <sub>A</sub> )	-55	+125	°C
DS9637AC			
Supply Voltage (V <sub>CC</sub> )	4.75	5.25	V
Operating Temperature (T <sub>A</sub> )	0	+70	°C

## Electrical Characteristics<sup>(1)(2)</sup>

Over recommended operating temperature and supply voltage ranges, unless otherwise specified

Symbol	Parameter	Conditions	Min	Typ	Max	Units
$V_{TH}$	Differential Input Threshold Voltage <sup>(3)</sup>	$-7.0V \leq V_{CM} \leq +7.0V$	-0.2		+0.2	V
$V_{TH(R)}$	Differential Input Threshold Voltage <sup>(4)</sup>	$-7.0V \leq V_{CM} \leq +7.0V$	-0.4		+0.4	V
$I_I$	Input Current <sup>(5)</sup>	$V_I = 10V, 0V \leq V_{CC} \leq +5.5V$		1.1	3.25	mA
		$V_I = -10V, 0V \leq V_{CC} \leq +5.5V$		-1.6	-3.25	
$V_{OL}$	Output Voltage LOW	$I_{OL} = 20 \text{ mA}, V_{CC} = \text{Min}$		0.35	0.5	V
$V_{OH}$	Output Voltage HIGH	$I_{OH} = -1.0 \text{ mA}, V_{CC} = \text{Min}$	2.5	3.5		V
$I_{OS}$	Output Short Circuit Current <sup>(6)</sup>	$V_O = 0V, V_{CC} = \text{Max}$	-40	-75	-100	mA
$I_{CC}$	Supply Current	$V_{CC} = \text{Max}, V_{I+} = 0.5V,$		35	50	mA
		$V_{I-} = \text{GND}$				
$V_{HYST}$	Input Hysteresis	$V_{CM} = \pm 7.0V$ (See Curves)		70		mV

- (1) Unless otherwise specified Min/Max limits apply across the  $-55^{\circ}\text{C}$  to  $+125^{\circ}\text{C}$  temperature range for DS9637AM and across the  $0^{\circ}\text{C}$  to  $+70^{\circ}\text{C}$  range for the DS9637ASC. All typicals are given for  $V_{CC} = 5V$  and  $T_A = 25^{\circ}\text{C}$ .
- (2) All currents into the device pins are positive; all currents out of the device pins are negative. All voltages are referenced to ground unless otherwise specified.
- (3)  $V_{DIFF}$  (Differential Input Voltage) =  $(V_{I+}) - (V_{I-})$ .  $V_{CM}$  (Common Mode Input Voltage) =  $V_{I+}$  or  $V_{I-}$ .
- (4)  $500\Omega \pm 1\%$  in series with inputs.
- (5) The input not under test is tied to ground.
- (6) Only one output at a time should be shorted.

## Switching Characteristics

$V_{CC} = 5.0V, T_A = 25^{\circ}\text{C}$

Symbol	Parameter	Conditions	Min	Typ	Max	Units
$t_{PLH}$	Propagation Delay Time Low to High	See AC Test Circuit		15	25	ns
$t_{PHL}$	Propagation Delay Time High to Low	See AC Test Circuit		13	25	ns

### Equivalent Circuit

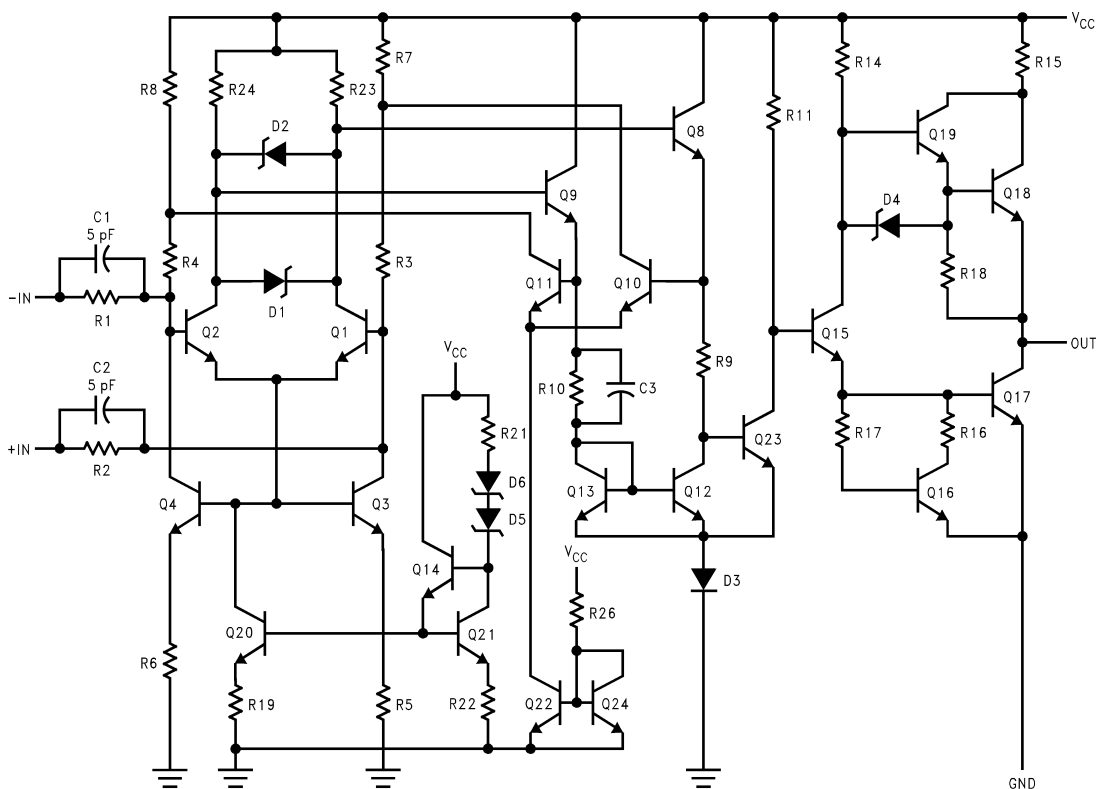

Figure 2. Equivalent Circuit

### Typical Input/Output Transfer Characteristics

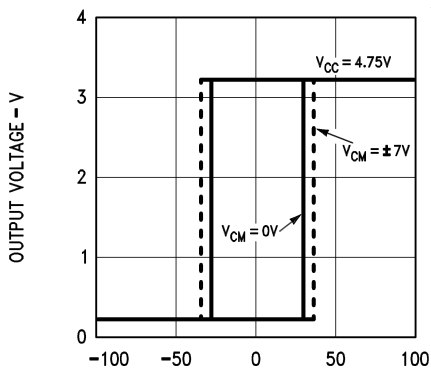

Figure 3.

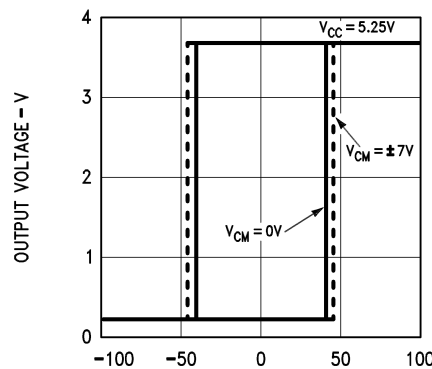
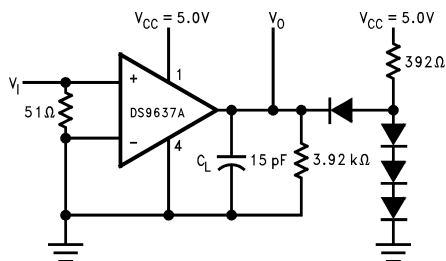

Figure 4.

### AC TEST CIRCUIT AND WAVEFORMS



**Notes:**

$C_L$  includes jig and probe capacitance.  
All diodes are FD700 or equivalent.

**Figure 5. AC Test Circuit and Waveforms**

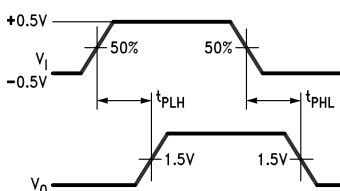

$V_I$   
Amplitude: 1.0V  
Offset: 0.5V  
Pulse Width: 100 ns  
PRR: 5.0 MHz  
 $t_r = t_f \leq 5.0$  ns

### Figure 6. Typical Applications

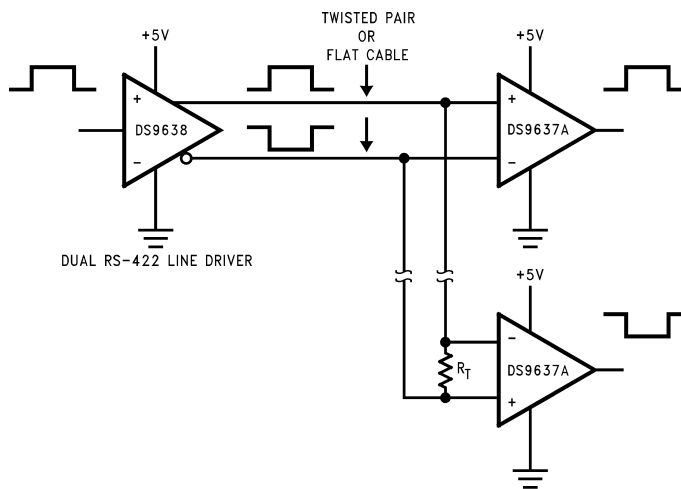

**Notes:**

$R_T \geq 50\Omega$  for RS-422 operation.  
 $R_T$  combined with input impedance of receivers must be greater than  $90\Omega$ .

**Figure 7. RS-422 System Application (FIPS 1020) Differential Simplex Bus Transmission**

### REVISION HISTORY

Changes from Revision C (April 2013) to Revision D	Page
• Changed layout of National Data Sheet to TI format .....	<a href="#">5</a>

## IMPORTANT NOTICE

Texas Instruments Incorporated and its subsidiaries (TI) reserve the right to make corrections, enhancements, improvements and other changes to its semiconductor products and services per JESD46, latest issue, and to discontinue any product or service per JESD48, latest issue. Buyers should obtain the latest relevant information before placing orders and should verify that such information is current and complete. All semiconductor products (also referred to herein as "components") are sold subject to TI's terms and conditions of sale supplied at the time of order acknowledgment.

TI warrants performance of its components to the specifications applicable at the time of sale, in accordance with the warranty in TI's terms and conditions of sale of semiconductor products. Testing and other quality control techniques are used to the extent TI deems necessary to support this warranty. Except where mandated by applicable law, testing of all parameters of each component is not necessarily performed.

TI assumes no liability for applications assistance or the design of Buyers' products. Buyers are responsible for their products and applications using TI components. To minimize the risks associated with Buyers' products and applications, Buyers should provide adequate design and operating safeguards.

TI does not warrant or represent that any license, either express or implied, is granted under any patent right, copyright, mask work right, or other intellectual property right relating to any combination, machine, or process in which TI components or services are used. Information published by TI regarding third-party products or services does not constitute a license to use such products or services or a warranty or endorsement thereof. Use of such information may require a license from a third party under the patents or other intellectual property of the third party, or a license from TI under the patents or other intellectual property of TI.

Reproduction of significant portions of TI information in TI data books or data sheets is permissible only if reproduction is without alteration and is accompanied by all associated warranties, conditions, limitations, and notices. TI is not responsible or liable for such altered documentation. Information of third parties may be subject to additional restrictions.

Resale of TI components or services with statements different from or beyond the parameters stated by TI for that component or service voids all express and any implied warranties for the associated TI component or service and is an unfair and deceptive business practice. TI is not responsible or liable for any such statements.

Buyer acknowledges and agrees that it is solely responsible for compliance with all legal, regulatory and safety-related requirements concerning its products, and any use of TI components in its applications, notwithstanding any applications-related information or support that may be provided by TI. Buyer represents and agrees that it has all the necessary expertise to create and implement safeguards which anticipate dangerous consequences of failures, monitor failures and their consequences, lessen the likelihood of failures that might cause harm and take appropriate remedial actions. Buyer will fully indemnify TI and its representatives against any damages arising out of the use of any TI components in safety-critical applications.

In some cases, TI components may be promoted specifically to facilitate safety-related applications. With such components, TI's goal is to help enable customers to design and create their own end-product solutions that meet applicable functional safety standards and requirements. Nonetheless, such components are subject to these terms.

No TI components are authorized for use in FDA Class III (or similar life-critical medical equipment) unless authorized officers of the parties have executed a special agreement specifically governing such use.

Only those TI components which TI has specifically designated as military grade or "enhanced plastic" are designed and intended for use in military/aerospace applications or environments. Buyer acknowledges and agrees that any military or aerospace use of TI components which have **not** been so designated is solely at the Buyer's risk, and that Buyer is solely responsible for compliance with all legal and regulatory requirements in connection with such use.

TI has specifically designated certain components as meeting ISO/TS16949 requirements, mainly for automotive use. In any case of use of non-designated products, TI will not be responsible for any failure to meet ISO/TS16949.

### Products

Audio	<a href="http://www.ti.com/audio">www.ti.com/audio</a>
Amplifiers	<a href="http://amplifier.ti.com">amplifier.ti.com</a>
Data Converters	<a href="http://dataconverter.ti.com">dataconverter.ti.com</a>
DLP® Products	<a href="http://www.dlp.com">www.dlp.com</a>
DSP	<a href="http://dsp.ti.com">dsp.ti.com</a>
Clocks and Timers	<a href="http://www.ti.com/clocks">www.ti.com/clocks</a>
Interface	<a href="http://interface.ti.com">interface.ti.com</a>
Logic	<a href="http://logic.ti.com">logic.ti.com</a>
Power Mgmt	<a href="http://power.ti.com">power.ti.com</a>
Microcontrollers	<a href="http://microcontroller.ti.com">microcontroller.ti.com</a>
RFID	<a href="http://www.ti-rfid.com">www.ti-rfid.com</a>
OMAP Applications Processors	<a href="http://www.ti.com/omap">www.ti.com/omap</a>
Wireless Connectivity	<a href="http://www.ti.com/wirelessconnectivity">www.ti.com/wirelessconnectivity</a>

### Applications

Automotive and Transportation	<a href="http://www.ti.com/automotive">www.ti.com/automotive</a>
Communications and Telecom	<a href="http://www.ti.com/communications">www.ti.com/communications</a>
Computers and Peripherals	<a href="http://www.ti.com/computers">www.ti.com/computers</a>
Consumer Electronics	<a href="http://www.ti.com/consumer-apps">www.ti.com/consumer-apps</a>
Energy and Lighting	<a href="http://www.ti.com/energy">www.ti.com/energy</a>
Industrial	<a href="http://www.ti.com/industrial">www.ti.com/industrial</a>
Medical	<a href="http://www.ti.com/medical">www.ti.com/medical</a>
Security	<a href="http://www.ti.com/security">www.ti.com/security</a>
Space, Avionics and Defense	<a href="http://www.ti.com/space-avionics-defense">www.ti.com/space-avionics-defense</a>
Video and Imaging	<a href="http://www.ti.com/video">www.ti.com/video</a>

### TI E2E Community

[e2e.ti.com](http://e2e.ti.com)

# Mouser Electronics

Authorized Distributor

Click to View Pricing, Inventory, Delivery & Lifecycle Information:

[Texas Instruments:](#)

[DS9637ACM](#) [DS9637ACM/NOPB](#) [DS9637ACMX](#) [DS9637ACMX/NOPB](#)