

20-1500W Single Output Industrial Power Supplies

<https://product.tdk.com/en/power/hws-hd>
www.emea.lambda.tdk.com/hws-hd

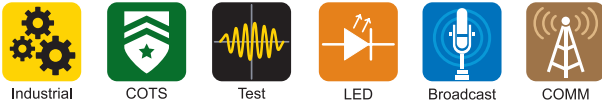
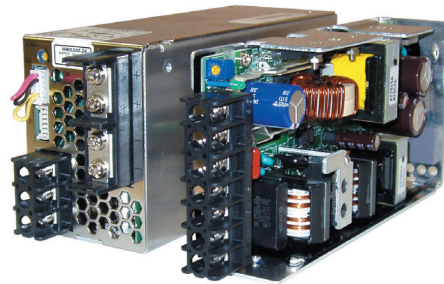

The ultra reliable, conservatively rated HWS/HD series of 20W to 1500W AC-DC power supplies has a limited lifetime warranty⁽¹⁾, unique to the industry. Based on the HWS-A and HWS series, the models offer pcb coating and start-up in -40°C ambient temperatures as standard for harsh environments. They accept a wide range 85 to 265Vac input with output voltages from 3.3V to 60V and are certified to IEC 62368-1. The HWS/HD also meet conducted and radiated emission standards without additional filtering or shielding.

Features	Benefits
• Pcb Coating and -40°C Ambient Start-up	• Operation in Harsh Environments
• Limited Lifetime Warranty ⁽¹⁾	• Low Cost of Ownership
• Very Conservative Electrolytic Capacitor Ratings	• Long Service Life
• Class B Conducted and Radiated EMI	• Easier System EMC Compliance

HWS	300	-	3	/	HD
Series	Nominal power level and product size		Output voltage 3 (3.3V), 5, 6, 7 (7.5V) 12, 15, 24, 36, 48, 60		blank No options /HDA The cover option for HWS50A-150A is special order only
					Preferred

Model Selector									
Model	Output Voltage (V)	Adjustment Range (V)	Maximum Current (A)	Peak Current (A) ⁽²⁾	Load Reg (mV)	Line Reg (mV)	Ripple Noise (mV)	Oversvoltage (V)	Efficiency (115/230Vac) (%)
HWS30A-3/HD	3.3	2.97 - 3.96	6	-	40	20	120	4.13 - 4.95	75 / 77
HWS50A-3/HD	3.3	2.97 - 3.96	10	-	40	20	120	4.13 - 4.95	82 / 84
HWS100A-3/HD	3.3	2.97 - 3.96	20	-	40	20	120	4.13 - 4.95	82 / 84
HWS150A-3/HD	3.3	2.97 - 3.96	30	-	40	20	120	4.13 - 4.95	78 / 81
HWS300-3/HD	3.3	2.64 - 3.96	60	-	30	20	120	4.13 - 4.95	74 / 77
HWS600-3/HD	3.3	2.64 - 3.96	120	-	30	20	120	4.13 - 4.95	75 / 78
HWS1000-3/HD	3.3	2.64 - 3.96	200	-	40	20	120	4.12 - 4.62	71 / 73
HWS1500-3/HD	3.3	2.64 - 3.96	300	-	60	36	150	4.12 - 4.62	72 / 75
HWS30A-5/HD	5	4.0 - 6.0	6	-	40	20	120	6.25 - 7.25	80 / 82
HWS50A-5/HD	5	4.0 - 6.0	10	-	40	20	120	6.25 - 7.25	82 / 84
HWS100A-5/HD	5	4.0 - 6.0	20	-	40	20	120	6.25 - 7.25	84 / 86
HWS150A-5/HD	5	4.0 - 6.0	30	-	40	20	120	6.25 - 7.25	85 / 87
HWS300-5/HD	5	4.0 - 6.0	60	-	30	20	120	6.25 - 7.25	79 / 82
HWS600-5/HD	5	4.0 - 6.0	120	-	30	20	120	6.25 - 7.25	80 / 83
HWS1000-5/HD	5	4.0 - 6.0	200	-	40	20	120	6.25 - 7.0	76 / 78
HWS1500-5/HD	5	4.0 - 6.0	300	-	60	36	150	6.25 - 7.0	77 / 81
HWS1000-6/HD	6	4.8 - 7.2	167	-	60	36	150	7.5 - 8.4	79 / 81
HWS1000-7/HD	7.5	6.0 - 9.0	134	160	60	36	150	9.37 - 10.5	80 / 82
HWS30A-12/HD	12	9.6 - 14.4	2.5	-	96	48	150	15.0 - 17.4	84 / 86
HWS50A-12/HD	12	9.6 - 14.4	4.3	-	96	48	150	15.0 - 17.4	83 / 85
HWS100A-12/HD	12	9.6 - 14.4	8.5	-	96	48	150	15.0 - 17.4	86 / 88
HWS150A-12/HD	12	9.6 - 14.4	13	-	96	48	150	15.0 - 17.4	85 / 88
HWS300-12/HD	12	9.6 - 14.4	27	-	72	48	150	15.0 - 17.4	80 / 83
HWS600-12/HD	12	9.6 - 14.4	53	-	72	48	150	15.0 - 17.4	80 / 83
HWS1000-12/HD	12	9.6 - 14.4	88	100	100	48	150	15.0 - 17.4	82 / 85
HWS1500-12/HD	12	9.6 - 14.4	125	-	72	48	150	15.0 - 17.4	82 / 85
HWS30A-15/HD	15	12.0 - 18.0	2	-	120	60	150	18.8 - 21.8	85 / 87
HWS50A-15/HD	15	12.0 - 18.0	3.5	-	120	60	150	18.8 - 21.8	83 / 86
HWS100A-15/HD	15	12.0 - 18.0	7	-	120	60	150	18.8 - 21.8	86 / 88
HWS150A-15/HD	15	12.0 - 18.0	10	-	120	60	150	18.8 - 21.8	86 / 89
HWS300-15/HD	15	12.0 - 18.0	22	-	90	60	150	18.8 - 21.8	80 / 83
HWS600-15/HD	15	12.0 - 18.0	43	-	90	60	150	18.8 - 21.8	81 / 84
HWS1000-15/HD	15	12.0 - 18.0	70	80	120	60	150	18.8 - 21.8	83 / 85
HWS1500-15/HD	15	12.0 - 18.0	100	-	90	60	150	18.8 - 21.8	83 / 87
HWS30A-24/HD	24	19.2 - 28.8	1.3	-	192	96	150	30.0 - 34.8	86 / 88
HWS50A-24/HD	24	19.2 - 28.8	2.2	-	192	96	150	30.0 - 34.8	84 / 87
HWS100A-24/HD	24	19.2 - 28.8	4.5	-	192	96	150	30.0 - 34.8	87 / 89
HWS150A-24/HD	24	19.2 - 28.8	6.5	-	192	96	150	30.0 - 34.8	88 / 90
HWS300-24/HD	24	19.2 - 28.8	14	16.5	144	96	150	30.0 - 34.8	82 / 85
HWS600-24/HD	24	19.2 - 28.8	27	31	144	96	150	30.0 - 34.8	82 / 85
HWS1000-24/HD	24	19.2 - 28.8	46	58.5	150	96	150	30.0 - 34.8	85 / 87
HWS1500-24/HD	24	19.2 - 28.8	65/70 ⁽³⁾	105	144	96	200	30.0 - 34.8	84 / 88
HWS1000-36/HD	36	28.8 - 43.2	30.7	39	150	144	200	45.0 - 49.7	85 / 88
HWS1500-36/HD	36	28.8 - 43.2	42/46.5 ⁽³⁾	70	150	144	200	45.0 - 49.7	84 / 88
HWS30A-48/HD	48	38.4 - 52.8	0.65	-	384	192	200	55.2 - 64.8	86 / 87
HWS50A-48/HD	48	38.4 - 52.8	1.1	-	384	192	200	55.2 - 64.8	84 / 86
HWS100A-48/HD	48	38.4 - 52.8	2.1	-	384	192	200	55.2 - 64.8	88 / 90
HWS150A-48/HD	48	38.4 - 52.8	3.3	-	384	192	200	55.2 - 64.8	89 / 91
HWS300-48/HD	48	38.4 - 52.8	7	-	288	192	200	55.2 - 64.8	82 / 85
HWS600-48/HD	48	38.4 - 52.8	13	-	288	192	200	55.2 - 64.8	83 / 86
HWS1000-48/HD	48	38.4 - 52.8	28	29.2	300	192	200	55.2 - 60.0	86 / 88
HWS1500-48/HD	48	38.4 - 52.8	32	-	288	192	200	55.2 - 64.8	86 / 90
HWS1000-60/HD	60	48.0 - 66.0	18.4	23.4	360	240	400	69.0 - 75.0	85 / 88

Specifications					
Model		HWS30A/HD HWS50A/HD	HWS100A/HD HWS150A/HD	HWS300/HD HWS600/HD	HWS1000/HD HWS1500/HD
Input					
Input Voltage Range (Operating)	Vac	85 - 265			
Nominal Input Voltage Range	Vac	100 - 240 (Note: Safety certified for 90-264Vac)			
Input Frequency	Hz	47 - 63 (Note: Safety certified for 50/60Hz only)			
DC Input Voltage range	Vdc	120 - 370 (Note: Safety certified for AC input only)		120 - 330 (Note: Safety certified for AC input only)	
Input Current (100/200Vac) ⁽⁴⁾	A	0.65 / 0.4 0.7 / 0.35	1.3 / 0.65 1.9 / 0.95	4.1 / 2.1 8.1 / 3.9	5-60V: 13.5/7.0 5-60V: 19.5/10.0
Inrush Current (100/200Vac)	A	14 / 28 (Typical at cold start)		20 / 40 (Typical at cold start)	
Leakage Current (240Vac, 60Hz)	mA	<0.5 (Typically 0.2 at 100Vac, 0.4 at 230Vac)		<0.75	<1.2 <1.5
Power Factor (100/200Vac)	-	N/A 0.97 / 0.91	0.98 / 0.93	0.99 / 0.95	0.98 / 0.95 0.98 / 0.94
Harmonic Compliance	-	Meets IEC61000-3-2 Class A			
Hold Up Time (typ)	ms	20			
Efficiency	-	See model selector table			
Conducted & Radiated EMI	-	EN55011 / EN55032-B, FCC-B, VCCI-B. (HWS1500: Class A)			
Immunity	-	See immunity table			
Safety Certifications and Markings	-	IEC/EN/UL/CSA62368-1, 60950-1, CE Mark and UKCA Mark			

Immunity				
Test	Standard	Test Level	Criteria	Notes See IEC61000 immunity test reports on website
ESD	EN61000-4-2	Air ± 8kV and contact ± 4kV	A/B	HWS30, 50, 100, 150, 300, 600; B
Radiated Susceptibility	EN61000-4-3	80M -1GHz: 10V/m 1.4 - 2.0GHz: 3V/m 2.0 - 2.7GHz: 1V/m	A	HWS30, 50, 100, 150; B
Electrical Fast Transient Burst	EN61000-4-4	± 2kV	A/B	HWS30, 50, 100, 150, 300, 600; B
Surge	EN61000-4-5	Normal ± 2kV Common ± 4kV	B	HWS30, 50, 100, 150, 300, 600; B
Conducted Susceptibility	EN61000-4-6	10Vrms	A	
Magnetic Fields	EN61000-4-8	30A/m	A	
Voltage Dips	EN61000-4-11	30% 500ms	A	
		60% 200ms	A	
		100% 20ms	A	
		100% 5000ms	B	
SEMI F47 Line Dip	SEMI F47	-	-	At input voltages > 200Vac

Specifications					
Model		HWS30A/HD HWS50A/HD	HWS100A/HD HWS150A/HD	HWS300/HD HWS600/HD	HWS1000/HD HWS1500/HD
Output					
Switching Frequency	kHz	100	120	190	3-5V: 45, 6-7V: 55, 12-60: 70
Line Regulation	mV	See Model Selector Table			
Load Regulation	mV	See Model Selector Table			
External Load Capacitance (Maximum)	uF	3.3V, 5V: 10,000 12V, 15V: 5,000 24V: 2,000, 48V: 500	3.3V, 5V: 10,000 12V, 15V: 10,000 24V: 5,000, 48V: 1,000	3.3V, 5V; 10,000 12V, 15V; up to 5,000 24V; up to 5,000, 48V; 1,000	
Ripple & Noise	-	See Model Selector Table			
Temperature Coefficient	%/°C	0.02			
Minimum Load	-	No minimum load required			
Overcurrent Protection	%	>105 (>101 of peak current for peak current capable models)			
Overvoltage Protection	-	See model selector table. Latching (unit shutdown), cycle AC input to reset			
Remote Sense	-	No		Yes	
Remote On/Off	-	No		Yes (Isolated from output)	
Indicators	-	Green LED indicates DC is OK			
Parallel Operation	-	No		Single wire connection (up to 5 units)	
Environmental					
Operating Temperature	°C	-10 to +70, derate linearly to 50% load from 50 to 70 ⁽⁵⁾ Guaranteed start up at -40°C (see specification sheets on website for details and derating)			
Storage Temperature	°C	-40 to +85			
Humidity (non condensing)	%RH	Operating: 30 - 90, Non operating 10 - 95		Operating: 10 - 90, Non operating 10 - 95	
Cooling	-	Convection		Internal fan	
Altitude	m	4,000		2,000	3,000 2,000
Withstand Voltage (For 1 minute)	Vac	Input to ground 2,000 Input to output 3,000 Output to ground 500		Input to ground 2,500 Input to output 3,000 Output to ground 500	Input to ground 2,000 Input to output 3,000 Output to ground 500
Isolation Resistance	MΩ	>100 at 25°C, 70%RH & 500Vdc			
Vibration (Non-operating)	-	MIL-STD-810F 514.5 Category 4, 10 (HWS1500 Cat 4, figure 514.5C-1)			
Shock (Non-operating)	-	MIL-STD-810F 516.5 Category I, VI (HWS1500 <196.1m/s ²)			
Other					
Weight (Typ)	g	240 300	470 520	1,000 1,600	3,200 4,000 (<12V 3,800)
Size (WxHxD)	mm	26.5 x 82 x 95 26.5 x 82 x 120	28 x 82 x 160 37 x 82 x 160	61 x 82 x 165 100 x 82 x 165	126.5 x 82 x 240 126.5 x 82 x 280
Size (WxHxD)	Inches	1.04 x 3.23 x 3.74 1.04 x 3.23 x 4.72	1.1 x 3.23 x 6.3 1.46 x 3.23 x 6.3	2.4 x 3.23 x 6.5 3.94 x 3.23 x 6.5	5 x 3.25 x 9.45 5 x 3.25 x 11
Connectors	-	Screw terminals			
Case Material	-	Aluminum			
MTBF - Telcordia SR-332 issue 3*	Hours	8,169,868 3,726,622	2,963,512 2,676,081	2,145,809 1,998,996	1,087,031 1,152,309
Warranty	Years	Limited lifetime ⁽¹⁾ or 5 years			

Notes

See website for detailed specifications, test methods and installation manual

(1) The Americas and EMEA regions: limited lifetime warranty. Other regions: 5 years. See applicable regional terms of sale.

(2) 200-265Vac input, 10s maximum on time with 35% duty cycle

(3) Rating at 100 / 200Vac input

(4) See website for input current on 3.3V and 5V models

(5) Input and output voltage dependent. See installation manuals for derating curves

* 24V output model, 25°C ambient, full load, 230Vac input

Outline Drawing HWS30A/HD

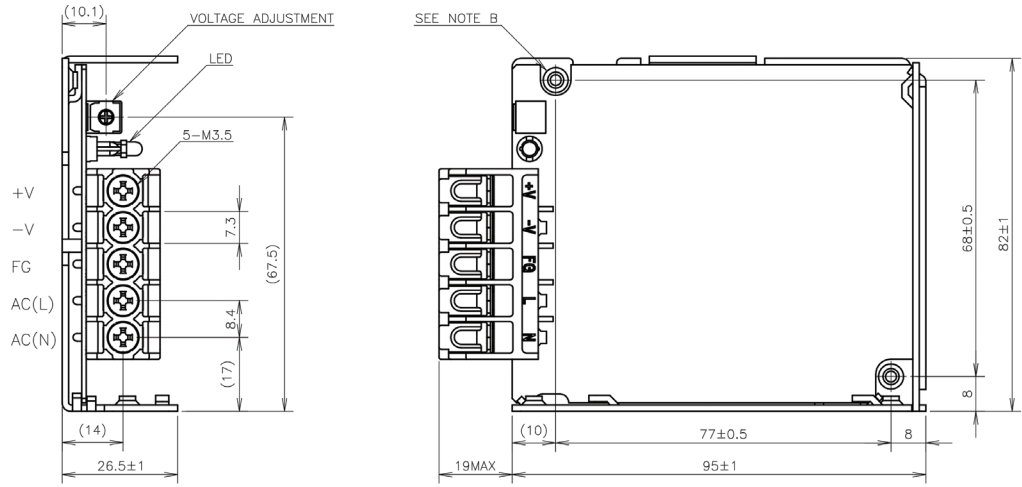

NOTES

- A : MODEL NAME, INPUT VOLTAGE RANGE, NOMINAL OUTPUT VOLTAGE, MAXIMUM OUTPUT CURRENT, COUNTRY OF MANUFACTURE AND SAFETY MARKING (FOR ONLY APPROVED PRODUCTS) ARE SHOWN HERE IN ACCORDANCE WITH THE SPECIFICATIONS.
- B : M3 EMBOSSED, TAPPED AND COUNTERSUNK HOLES (4) FOR CUSTOMER CHASSIS MOUNTING. SCREWS MUST NOT PROTRUDE INTO POWER SUPPLY BY MORE THAN 6mm.

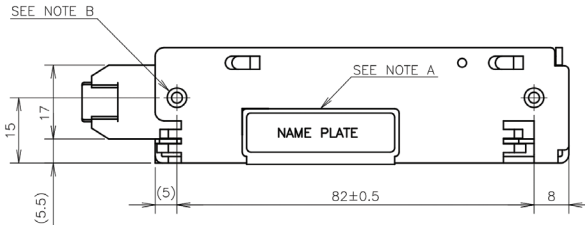

Outline Drawing HWS50A/HD

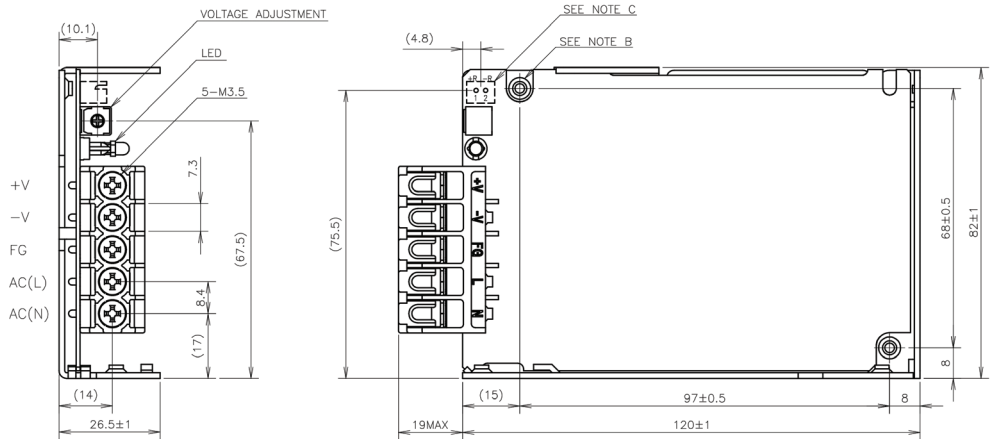

NOTES

- A : MODEL NAME, INPUT VOLTAGE RANGE, NOMINAL OUTPUT VOLTAGE, MAXIMUM OUTPUT CURRENT, COUNTRY OF MANUFACTURE AND SAFETY MARKING (FOR ONLY APPROVED PRODUCTS) ARE SHOWN HERE IN ACCORDANCE WITH THE SPECIFICATIONS.
- B : M3 EMBOSSED, TAPPED AND COUNTERSUNK HOLES (4) FOR CUSTOMER CHASSIS MOUNTING. SCREWS MUST NOT PROTRUDE INTO POWER SUPPLY BY MORE THAN 6mm.
- C : REMOTE ON/OFF CONTROL CONNECTOR --- OPTION B2B-XH-AM (JST)
 MATCHING HOUSING : XHP-2 (JST)
 MATCHING TERMINAL PIN : BXH-001T-P0.6 (JST) OR SXH-001T-P0.6 (JST)
 HAND CRIMPING TOOL : YC-110R (JST) OR YRS-110 (JST)
 MATCHING HOUSING AND TERMINAL PIN --- NOT INCLUDED WITH THE PRODUCT

OPTIONAL MODELS

MODEL	REMOTE ON/OFF CONTROL
HWS50A-*	—
HWS50A-*/R	○

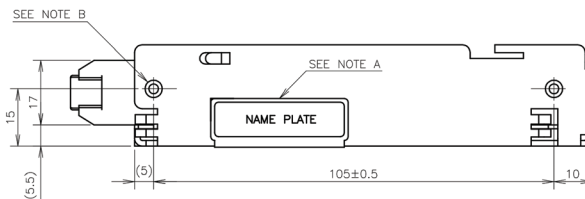

Outline Drawing HWS100A/HD

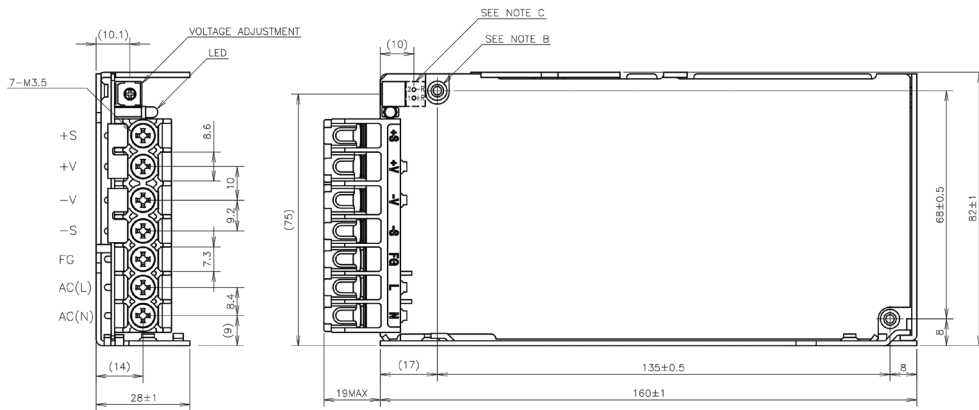

NOTES

- A : MODEL NAME, INPUT VOLTAGE RANGE, NOMINAL OUTPUT VOLTAGE, MAXIMUM OUTPUT CURRENT, COUNTRY OF MANUFACTURE AND SAFETY MARKING (FOR ONLY APPROVED PRODUCTS) ARE SHOWN HERE IN ACCORDANCE WITH THE SPECIFICATIONS.
- B : M3 EMBOSSED, TAPPED AND COUNTERSUNK HOLES (4) FOR CUSTOMER CHASSIS MOUNTING. SCREWS MUST NOT PROTRUDE INTO POWER SUPPLY BY MORE THAN 6mm.
- C : REMOTE ON/OFF CONTROL CONNECTOR --- OPTION B2B-XH-AM (JST)
 MATCHING HOUSING : XHP-2 (JST)
 MATCHING TERMINAL PIN : BXH-001T-P0.6 (JST) OR SXH-001T-P0.6 (JST)
 HAND CRIMPING TOOL : YC-110R (JST) OR YRS-110 (JST)
 MATCHING HOUSING AND TERMINAL PIN --- NOT INCLUDED WITH THE PRODUCT

ACCESSORIES

- * SHORT PIECE (NET 2) FOR SHORTING PURPOSE (+S~+V, -S~-V) : MOUNTED AT TIME OF SHIPMENT.

OPTIONAL MODELS

MODEL	REMOTE ON/OFF CONTROL
HWS100A-*	—
HWS100A-*/R1	○

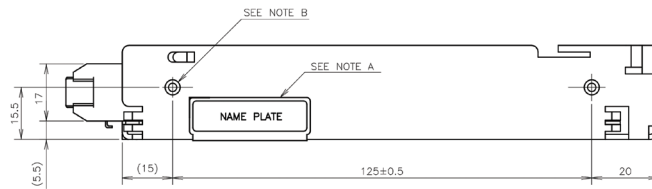

Outline Drawing HWS150A/HD

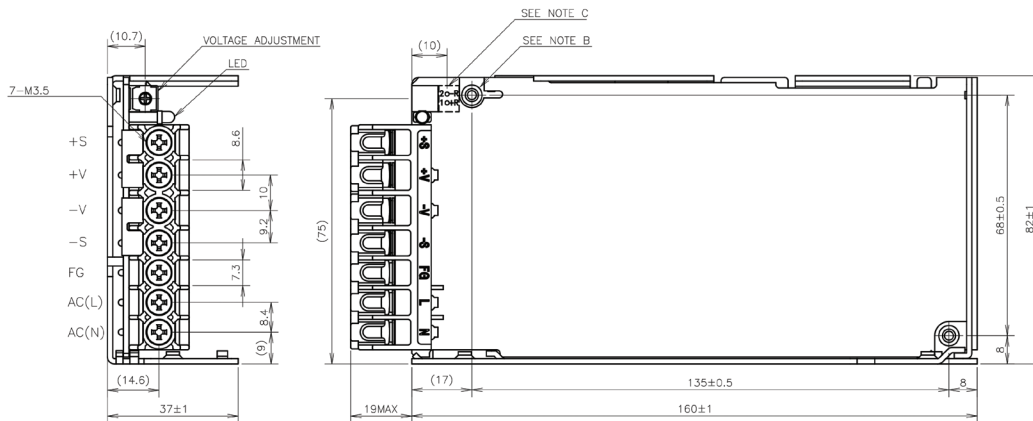

NOTES

- A : MODEL NAME, OPTION CODE, INPUT VOLTAGE RANGE, NOMINAL OUTPUT VOLTAGE, MAXIMUM OUTPUT CURRENT, COUNTRY OF MANUFACTURE AND SAFETY MARKING (FOR ONLY APPROVED PRODUCTS) ARE SHOWN HERE IN ACCORDANCE WITH THE SPECIFICATIONS.
- B : M3 EMBOSSED, TAPPED AND COUNTERSUNK HOLES (4) FOR CUSTOMER CHASSIS MOUNTING. SCREWS MUST NOT PROTRUDE INTO POWER SUPPLY BY MORE THAN 6mm.
- C : REMOTE ON/OFF CONTROL CONNECTOR --- OPTION B2B-XH-AM (JST)
 MATCHING HOUSING : XHP-2 (JST)
 MATCHING TERMINAL PIN : BXH-001T-P0.6 (JST) OR SXH-001T-P0.6 (JST)
 HAND CRIMPING TOOL : YC-110R (JST) OR YRS-110 (JST)
 MATCHING HOUSING AND TERMINAL PIN --- NOT INCLUDED

ACCESSORIES

- * SHORT PIECE (NET 2) FOR SHORTING PURPOSE (+S~+V, -S~-V) : MOUNTED AT TIME OF SHIPMENT.

OPTIONAL MODELS

MODEL	REMOTE ON/OFF CONTROL
HWS150A-*	—
HWS150A-*/R1	○

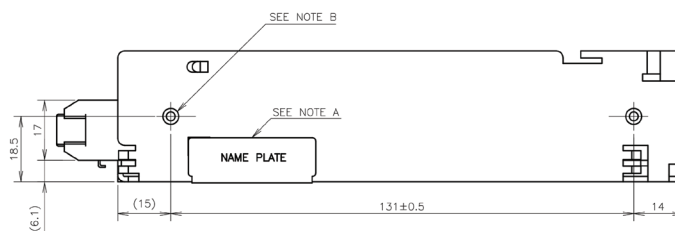

Outline Drawing HWS300/HD

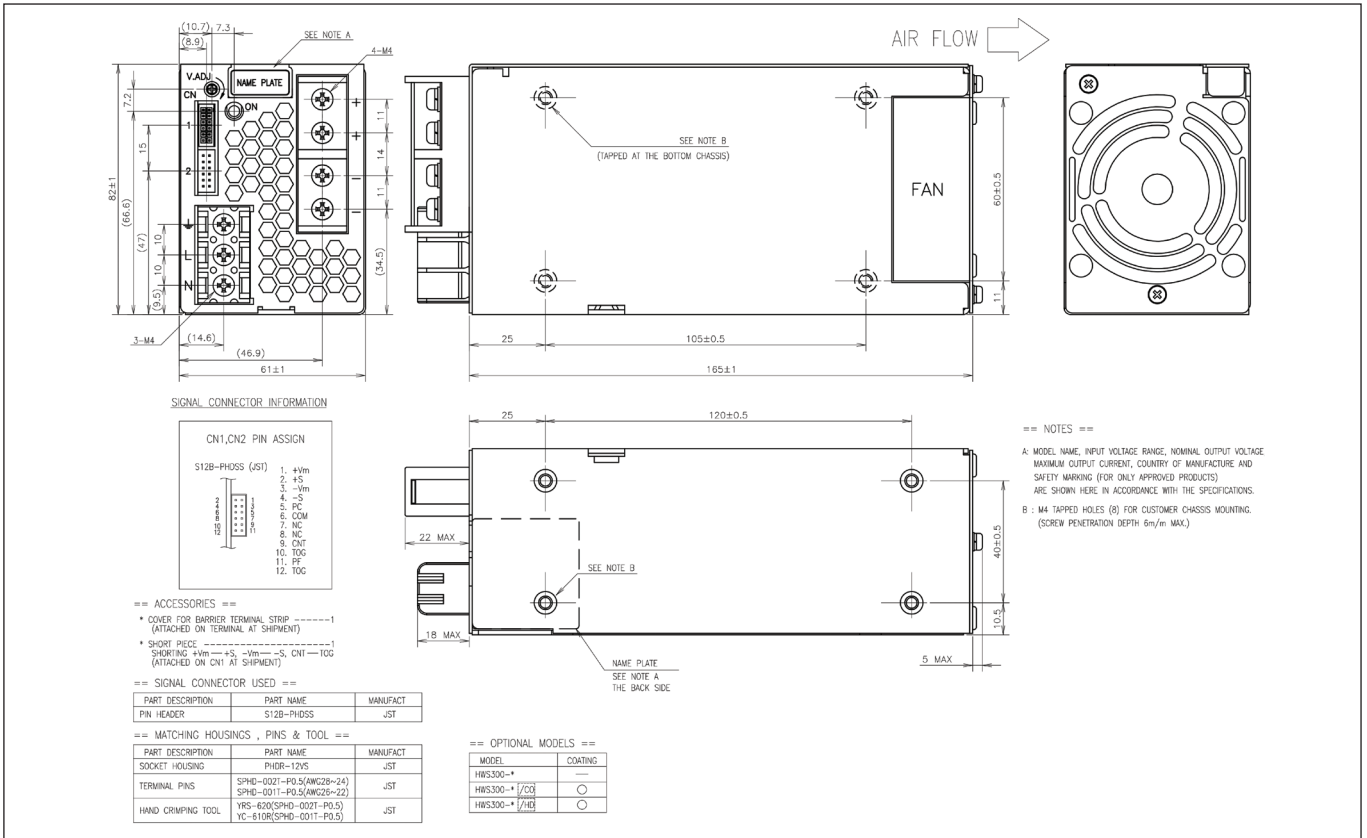

Outline Drawing HWS600/HD

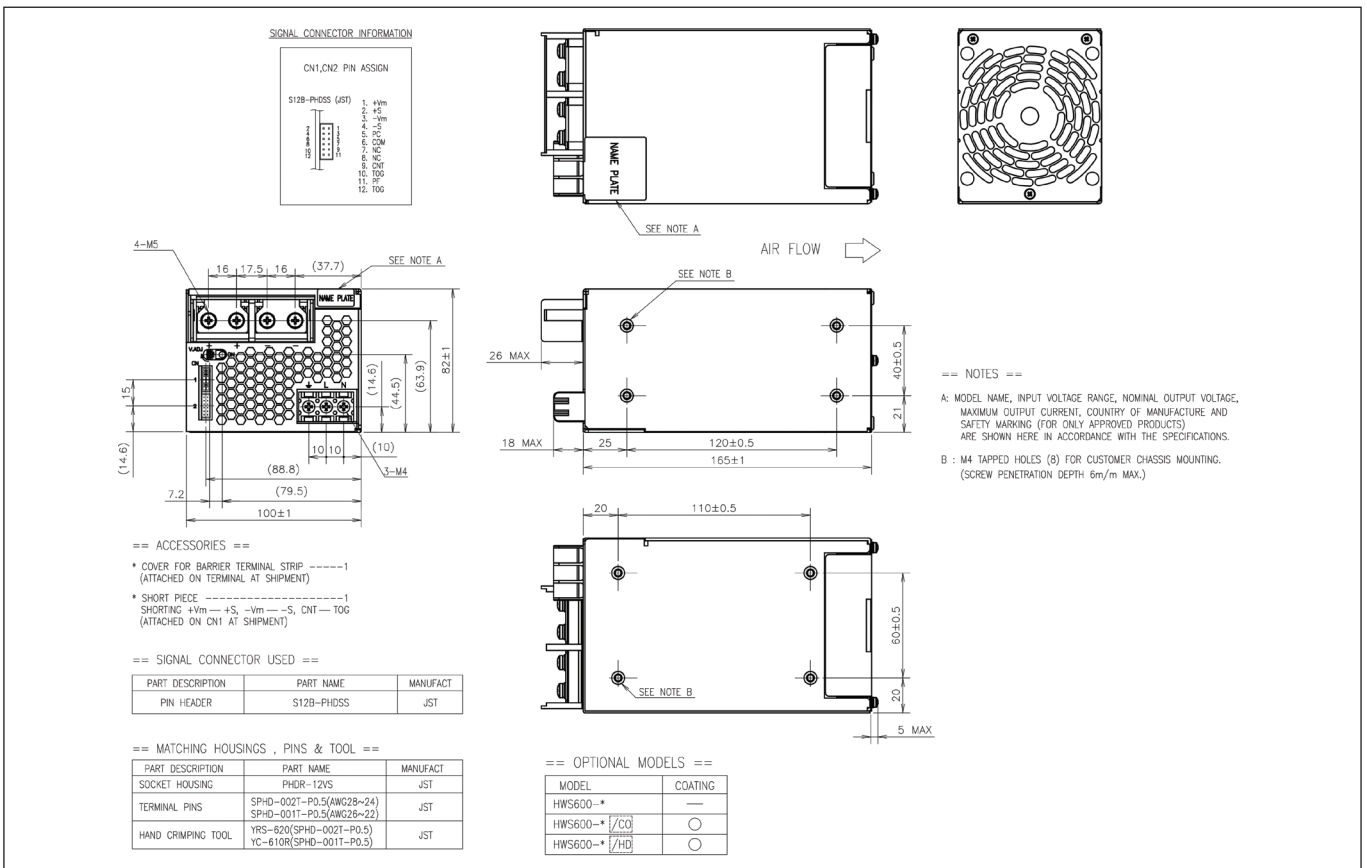

Outline Drawing HWS1000/HD

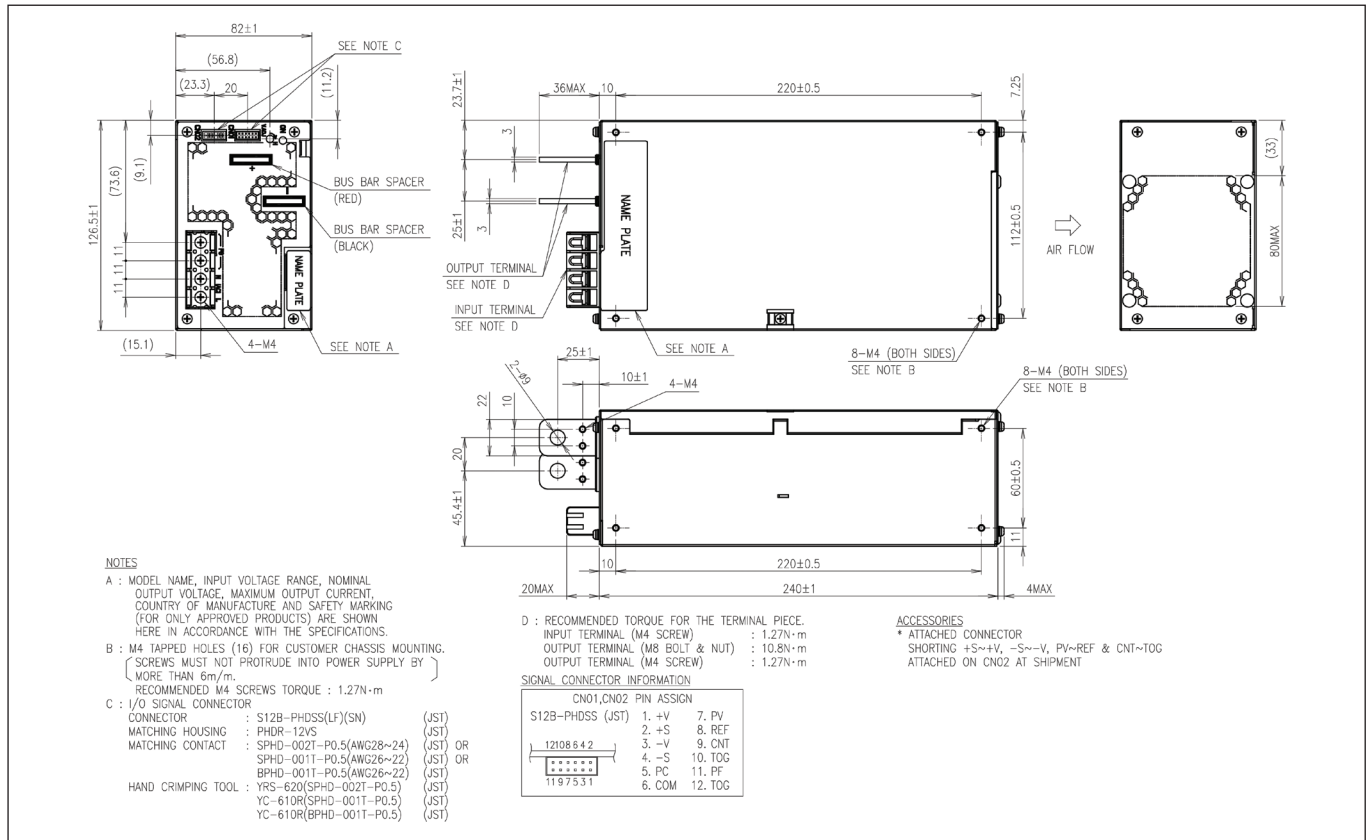

Outline Drawing HWS1500/HD

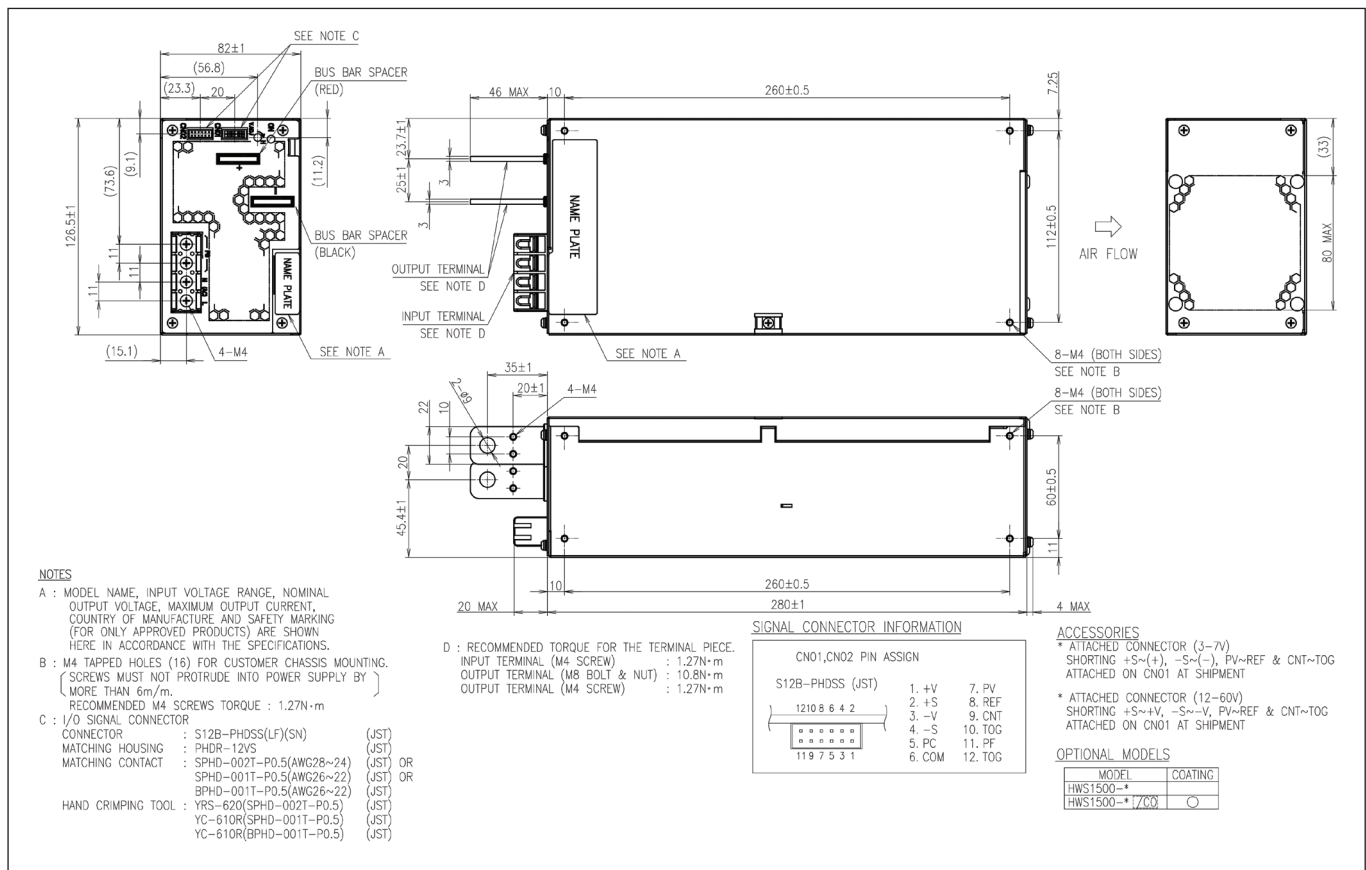



TDK-Lambda France SAS

Tel: +33 1 60 12 71 65
 tlf.fr-powersolutions@tdk.com
 www.emea.lambda.tdk.com/fr



Italy Sales Office

Tel: +39 02 61 29 38 63
 tlf.it-powersolutions@tdk.com
 www.emea.lambda.tdk.com/it



Netherlands

tlf.nl-powersolutions@tdk.com
 www.emea.lambda.tdk.com/nl



TDK-Lambda Germany GmbH

Tel: +49 7841 666 0
 tlq.powersolutions@tdk.com
 www.emea.lambda.tdk.com/de



Austria Sales Office

Tel: +43 2256 655 84
 tlq.at-powersolutions@tdk.com
 www.emea.lambda.tdk.com/at



Switzerland Sales Office

Tel: +41 44 850 53 53
 tlq.ch-powersolutions@tdk.com
 www.emea.lambda.tdk.com/ch



Nordic Sales Office

Tel: +45 8853 8086
 tlq.dk-powersolutions@tdk.com
 www.emea.lambda.tdk.com/dk



TDK-Lambda UK Ltd.

Tel: +44 (0) 12 71 85 66 66
 tlu.powersolutions@tdk.com
 www.emea.lambda.tdk.com/uk



TDK-Lambda Ltd.

Tel: +9 723 902 4333
 tli.powersolutions@tdk.com
 www.emea.lambda.tdk.com/il-en



TDK-Lambda Americas

Tel: +1 800-LAMBDA-4 or 1-800-526-2324
 tla.powersolutions@tdk.com
 www.us.lambda.tdk.com



TDK Electronics do Brasil Ltda

Tel: +55 11 3289-9599
 sales.br@tdk-electronics.tdk.com
 www.tdk-electronics.tdk.com/en



TDK-Lambda Corporation

Tel: +81-3-6778-1113
 www.jp.lambda.tdk.com



TDK-Lambda (China) Electronics Co. Ltd.

Tel: +86 21 6485-0777
 tlc.powersolutions@tdk.com
 www.lambda.tdk.com.cn



TDK-Lambda Singapore Pte Ltd.

Tel: +65 6251 7211
 tfs.marketing@tdk.com
 www.sg.lambda.tdk.com



TDK India Private Limited, Power Supply Division

Tel: +91 80 4039-0660
 mathew.philip@tdk.com
 www.sg.lambda.tdk.com



Mouser Electronics

Authorized Distributor

Click to View Pricing, Inventory, Delivery & Lifecycle Information:

[TDK-Lambda:](#)

[HWS1000-7/HD](#)