

0.4mm Pitch
Board to Board Connector

5804 Series

シリーズ (Series)	5804
基板間高さ (Stacking Height)	0.9 / 1.5 / 2.0mm
極間隔 (Pitch)	0.4mm
極数 (No. of Positions)	H=0.9mm; 10 to 60 Pos. H=1.5, 2.0mm; 10 to 80 Pos.
定格電流 (Rated Current)	DC 0.3A/Contact
定格電圧 (Rated Voltage)	DC 50V/Contact
耐電圧 (D. W. Voltage)	AC 250Vrms/min.
コンタクト材質 (Contact Material)	銅合金 (Copper alloy)
インシュレータ材質 (Insulator Material)	耐熱樹脂 (Heat-resistant plastic)
使用温度範囲 (Operating Temperature)	-40 to +85°C

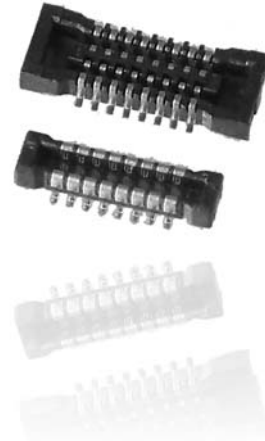

◆概要

5804 シリーズは、市場における携帯電話やデジタル AV 機器等の小型化、薄型化の要求に基づき開発された 0.4mm ピッチ、嵌合高さ 0.9mm/1.5mm/2.0mm の基板対基板コネクタです。幅寸法は 2.4mm と、省面積化を実現しています。

◆特長

- (1) 嵌合高さ 0.9mm/1.5mm/2.0mm、幅 2.4mm のスリムタイプのコネクタで、基板実装面積の省面積化に貢献します。
- (2) スリム・低背でありながらコネクタ裏面に下壁を設け金属の露出がなく、製品の端子ランド対向間にパターン配線が可能であり、高密度実装に最適な構造です。
- (3) 接点部は、「狭み込み接点形状」(2点接点)を採用し、振動や落下衝撃などに強い構造となっています。また、プラグコンタクトの形状は、集中荷重を上げて異物を排除(ワイピング効果)する機構を施し、高い接触信頼性を実現しています。
- (4) 嵌合時のロック構造は、独自のロック構造を採用。低背でありながらも優れたクリック感と、抜去時の保持力を強化しています。
- (5) 2,000 個または 5,000 個入りのエンボステープ梱包です。
- (6) 環境に優しい RoHS 指令対応品です。

◆Outline

The 5804 Series are 0.4mm pitch, ultra low profile Board to Board Connectors featuring a stacking height of 0.9/1.5/2.0mm. These products were developed to meet market needs for miniaturization of mobile phones, digital AV equipment, etc. Space saving is greatly achieved with a width of 2.4mm.

◆Features

- (1) Space saving is greatly achieved on the PCB with a stacking height of 0.9/1.5/2.0mm and width of 2.4mm.
- (2) There is little dead space as metal is not exposed on the back of the connector. Thus, it is possible to form wiring patterns on the substrate area which is positioned between the terminals, realizing a suitable structure for high-density packaging.
- (3) A pinching structure (two-point contact design), which is highly resistant to vibrations and drop shocks, has been adopted for the contact structure. Furthermore, the plug contacts have an original structure featuring a wiping effect which eliminates foreign matter with concentrated load, thus realizing high contact reliability.
- (4) An original locking structure is adopted for the mating lock structure, which generates a firm "click" sound and enhances the retention force when connectors are removed despite the low profile.
- (5) Packaged in tape and reel: 2,000 or 5,000 pieces/reel.
- (6) RoHS compliant product.

本カタログには推奨めっきを掲載しております。めっき種類・仕様、ならびに生産対応可能極数については営業部にご確認願います。
Recommended plating types are mentioned in this catalogue. For other plating types and their specifications, and available numbers of positions, please feel free to contact our sales department.

0.4mm Pitch 5804 Series

0.4mm ピッチ 嵌合高さ 0.9mm 金具無し SMT
0.4mm Pitch, Stacking Height=0.9mm, Without Metal tab, SMT

● Plug

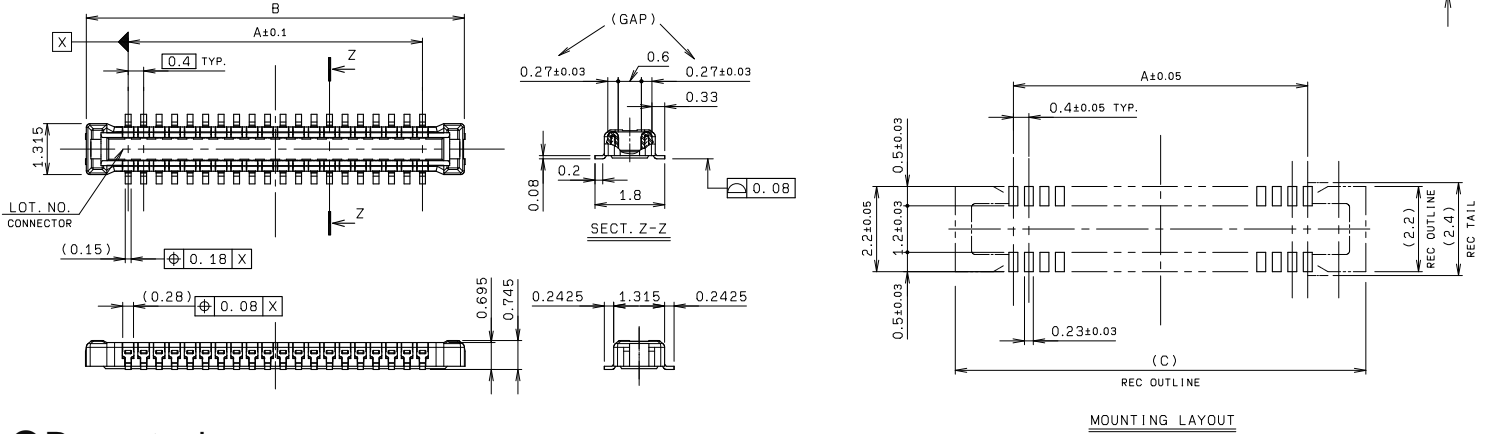

● Receptacle

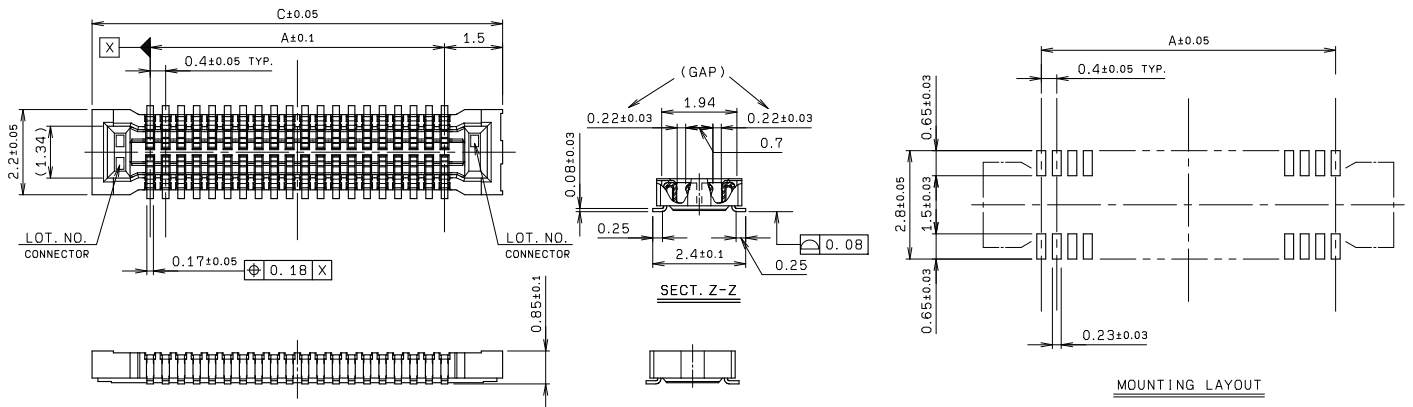

● Packaging

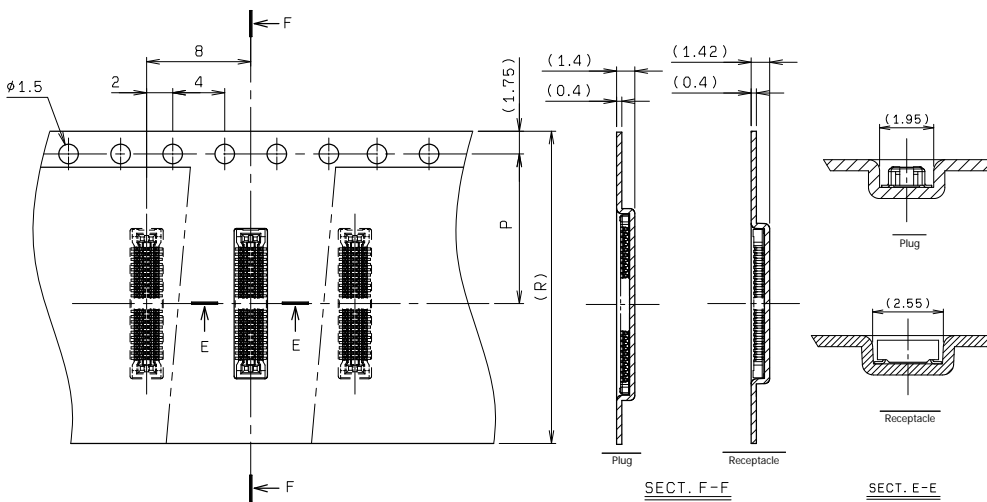

極数 NO. OF POS.	A	B	C	P	R
10	1.6	3.76	4.6	5.5	12.0
12	2.0	4.16	5.0	5.5	12.0
14	2.4	4.56	5.4	7.5	16.0
16	2.8	4.96	5.8	7.5	16.0
18	3.2	5.36	6.2	7.5	16.0
20	3.6	5.76	6.6	7.5	16.0
22	4.0	6.16	7.0	7.5	16.0
24	4.4	6.56	7.4	7.5	16.0
26	4.8	6.96	7.8	7.5	16.0
30	5.6	7.76	8.6	7.5	16.0
32	6.0	8.16	9.0	7.5	16.0
34	6.4	8.56	9.4	11.5	24.0
40	7.6	9.76	10.6	11.5	24.0
44	8.4	10.56	11.4	11.5	24.0
50	9.6	11.76	12.6	11.5	24.0
54	10.4	12.56	13.4	11.5	24.0
60	11.6	13.76	14.6	11.5	24.0

注文コード/Ordering Code

Plug
Part No. **14 5804 0XX 020 829+**
極数 No. of Pos.

Receptacle
Part No. **24 5804 0XX 500 829+**
極数 No. of Pos.

RoHS 対応品
RoHS Compliant Product

梱包数量：5,000個/リール
PACKING QUANTITY: 5,000/Reel

本カタログには推奨めっきを掲載しております。めっき種類・仕様、ならびに生産対応可能極数については営業部にご確認願います。
Recommended plating types are mentioned in this catalogue. For other plating types and their specifications, and available numbers of positions, please feel free to contact our sales department.

0.4mm Pitch 5804 Series



0570-1511-0
059B-1604-0
040D-1511-0
037C-1511-0
041B-1604-0

KYOCERA Connector Products Corporation

0.4mm ピッチ 嵌合高さ 1.5mm&2.0mm 金具無し SMT
0.4mm Pitch, Stacking Height=1.5mm&2.0mm, Without Metal tab, SMT

● Plug

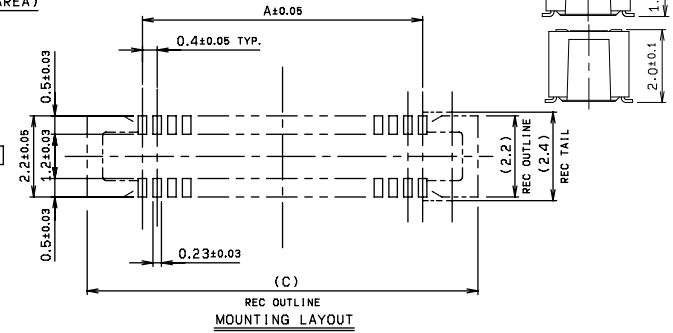
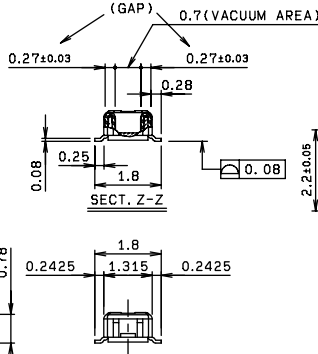
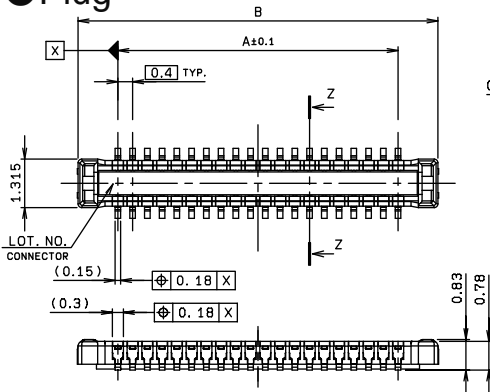

MATING CONDITION

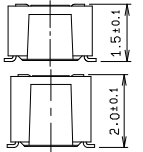

● Receptacle

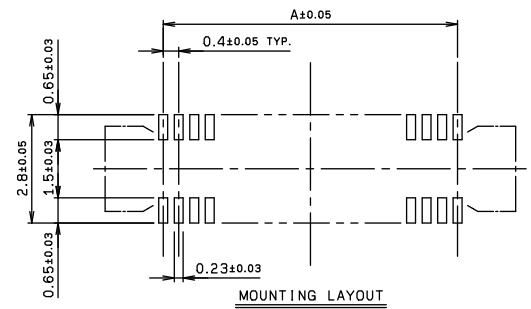
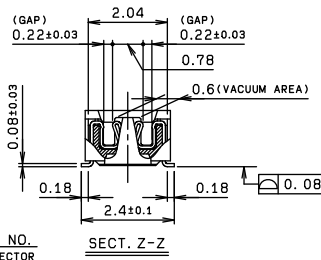
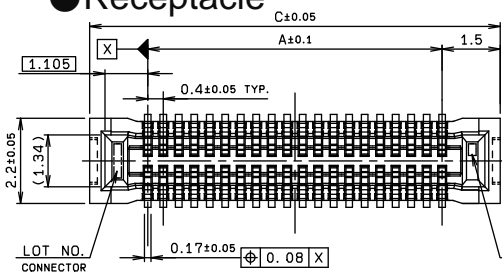

E	Stacking Height: 1.5mm	1.45mm
	Stacking Height: 2.0mm	1.95mm

● Packaging

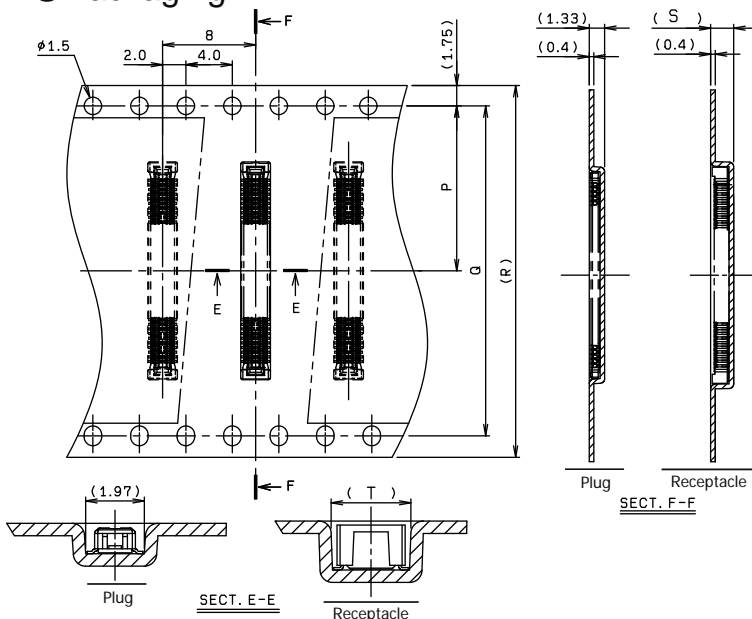

極数 NO. OF POS.	A	B	C	P	Q	R	Stack. H=1.5mm		Stack. H=2.0mm	
							S	T	S	T
							10	1.6	3.76	4.6
12	2.0	4.16	5.0	5.5	-	12.0	1.98	2.57	2.48	2.55
14	2.4	4.56	5.4	7.5	-	16.0	1.98	2.57	2.48	2.55
16	2.8	4.96	5.8	7.5	-	16.0	1.98	2.57	2.48	2.55
18	3.2	5.36	6.2	7.5	-	16.0	1.98	2.57	2.48	2.55
20	3.6	5.76	6.6	7.5	-	16.0	1.98	2.57	2.48	2.55
22	4.0	6.16	7.0	7.5	-	16.0	1.98	2.57	2.48	2.55
24	4.4	6.56	7.4	7.5	-	16.0	1.98	2.57	2.48	2.55
26	4.8	6.96	7.8	7.5	-	16.0	1.98	2.57	2.48	2.55
30	5.6	7.76	8.6	7.5	-	16.0	1.98	2.57	2.48	2.55
32	6.0	8.16	9.0	7.5	-	16.0	1.98	2.57	2.48	2.55
34	6.4	8.56	9.4	11.5	-	24.0	1.98	2.57	2.48	2.55
40	7.6	9.76	10.6	11.5	-	24.0	1.98	2.57	2.48	2.55
44	8.4	10.56	11.4	11.5	-	24.0	1.98	2.57	2.48	2.55
46	8.8	10.96	11.8	11.5	-	24.0	1.98	2.57	2.48	2.55
50	9.6	11.76	12.6	11.5	-	24.0	1.98	2.57	2.48	2.55
54	10.4	12.56	13.4	11.5	-	24.0	1.98	2.57	2.48	2.55
60	11.6	13.76	14.6	11.5	-	24.0	1.98	2.57	2.48	2.55
64	12.4	14.56	15.4	11.5	-	24.0	1.98	2.57	2.48	2.55
70	13.6	15.76	16.6	11.5	-	24.0	1.98	2.57	2.48	2.55
74	14.4	16.56	17.4	14.2	28.4	32.0	1.98	2.57	2.48	2.55
80	15.6	17.76	18.6	14.2	28.4	32.0	1.98	2.57	2.48	2.55

※極数により梱包仕様異なる可能性があります。
For some numbers of positions, the packaging specification would vary.

注文コード/Ordering Code

Plug
Part No. 14 5804 0XX 050 829+

Receptacle
Part No. 24 5804 0XX 0X0 829+

RoHS 対応品
RoHS Compliant Product

2: Stack. H=1.5mm
3: Stack. H=2.0mm

梱包数量: 2,000個/リール
PACKING QUANTITY: 2,000/Reel

本カタログには推奨めっきを掲載しております。めっき種類・仕様、ならびに生産対応可能極数については営業部にご確認願います。
Recommended plating types are mentioned in this catalogue. For other plating types and their specifications, and available numbers of positions, please feel free to contact our sales department.

Mouser Electronics

Authorized Distributor

Click to View Pricing, Inventory, Delivery & Lifecycle Information:

[AVX:](#)

[245804020000829+](#) [245804010000829+](#) [145804010000829+](#) [245804050000829+](#) [245804060000829+](#)
[145804024000829+](#) [245804030000829+](#) [145804040000829+](#) [245804040000829+](#) [245804014000829+](#)