



# TAOGLAS®



# Datasheet

## Hercules

**Part No:**  
IS.01.B.305111

### Description

433 MHz Heavy Duty Screw Mount Antenna

### Features:

Hercules Screw-Mount  
0dBi ISM 433 MHz Band  
Cable: 3m CFD200  
Connector: SMA (M)  
29mm\*49mm (Diameter)  
IP65 Rated Enclosure  
RoHS & REACH Compliant

<b>1.</b>	<b>Introduction</b>	<b>2</b>
<b>2.</b>	<b>Specification</b>	<b>3</b>
<b>3.</b>	<b>Antenna Characteristics</b>	<b>4</b>
<b>4.</b>	<b>Radiation Patterns</b>	<b>8</b>
<b>5.</b>	<b>Mechanical Drawing</b>	<b>23</b>
<b>6.</b>	<b>Installation</b>	<b>24</b>
<b>7.</b>	<b>Packaging</b>	<b>25</b>
<hr/>		
	Changelog	26

Taoglas makes no warranties based on the accuracy or completeness of the contents of this document and reserves the right to make changes to specifications and product descriptions at any time without notice. Taoglas reserves all rights to this document and the information contained herein. Reproduction, use or disclosure to third parties without express permission is strictly prohibited.



## 1. Introduction



The IS.01 is a high performance 433MHz thread mount antenna for external use on mesh Networks, vehicles and outdoor and indoor assets. It is designed for heavy duty work with extra thick threads. Durable UV resistant PC housing is IP65 rated, resistant to vandalism and direct attack. At only 29mm high it complies with the latest EU directives for vehicle height restrictions, whilst also enabling covert operation with a diameter of 49mm.

## 2. Specification

Electrical									
Band	Frequency (MHz)	Measurement	Efficiency (%)	Average Gain (dB)	Peak Gain (dBi)	Impedance	Polarization	Radiation Pattern	Input power
411.5MHz	411-412	30cmX30cm Ground Plane	67.1	-1.73	4.52	50 Ω	Linear	Omni	5W
		Freespace	41.0	-3.87	0.82				
420MHz	419-421	30cmX30cm Ground Plane	62.3	-2.05	4.53				
		Freespace	48.3	-3.16	2.36				
433MHz	432-434	30cmX30cm Ground Plane	56.0	-2.52	4.47				
		Freespace	65.2	-1.85	3.45				

Mechanical	
Dimensions	Height=29mm x Diameter=49mm
Material	UV Resistant PC
Connector	SMA Male (Fully Customizable)
Cable	3m CFD-200 (Fully Customizable)
Base and Thread	Nickel plated steel
Weather-proof gasket	CR4305 foam with 3M9448B double-side adhesive
Thread Diameter	18mm
Sealant	Rubber Stopper

Environmental	
Waterproof Rating	IP65
Operation Temperature	-40°C to +85°C
Relative Humidity	Non-condensing 65 C 95% RH
Corrosion	5% NaCl for 48hrs- Nickel plated steel base and thread
Shock (Drop Test)	1m drop on concrete 6 axes
Cable Pull	8 kgf

### 3. Antenna Characteristics

#### 3.1 Test Setup

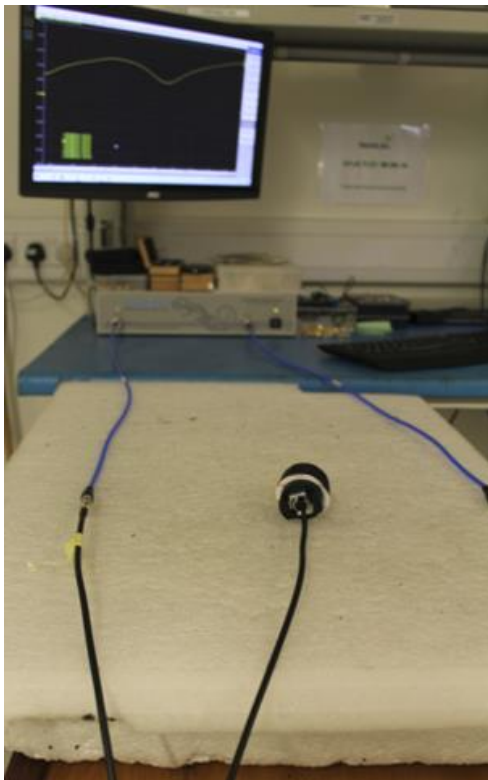
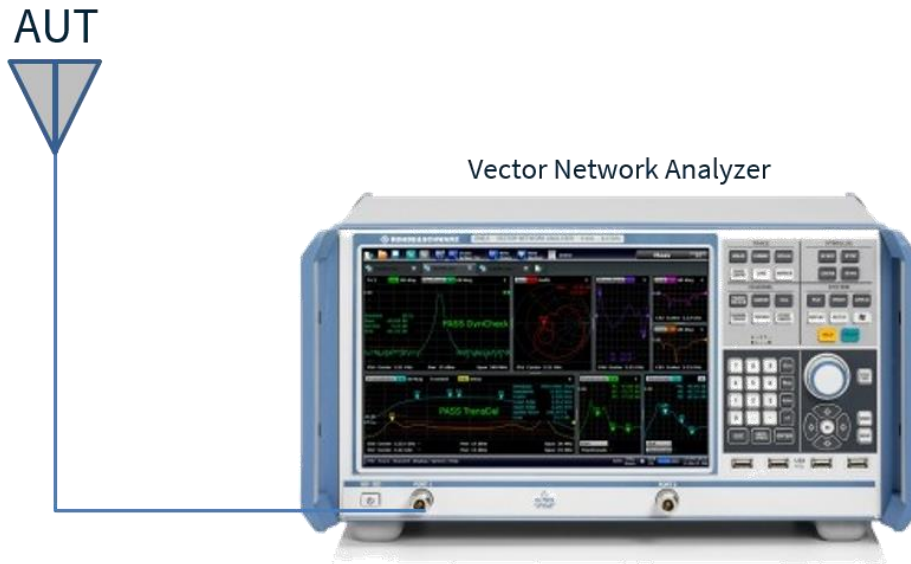

Free Space

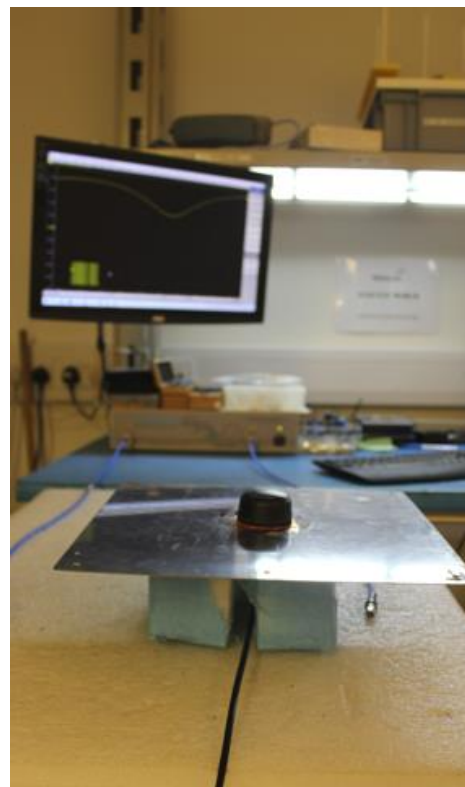

30x30cm Ground Plane

### 3.2 Return Loss

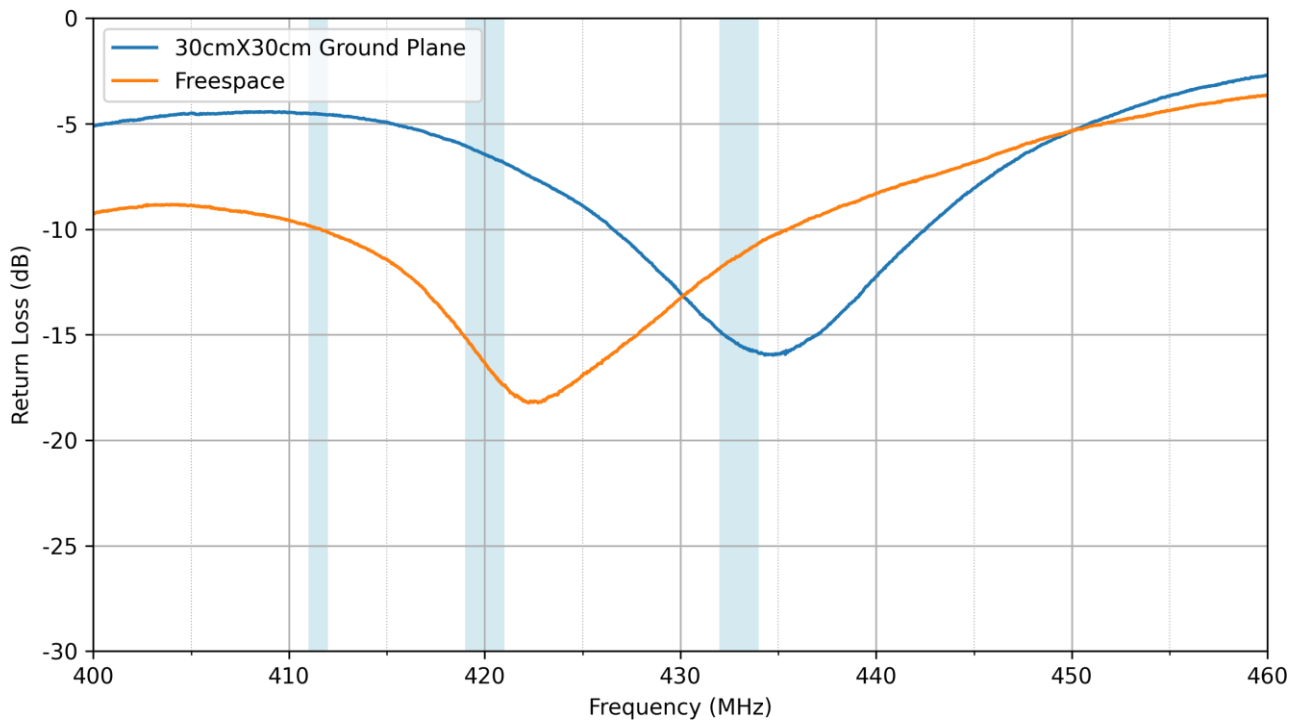

### 3.3 VSWR

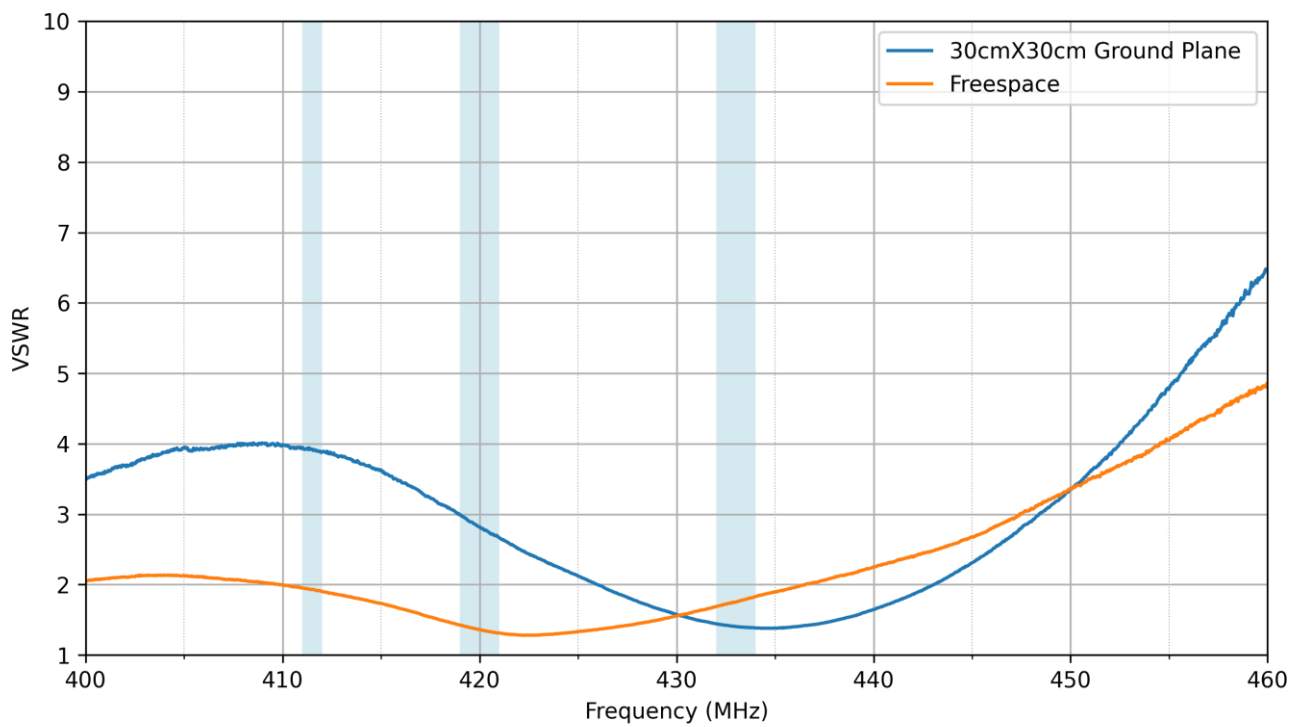

### 3.4 Efficiency

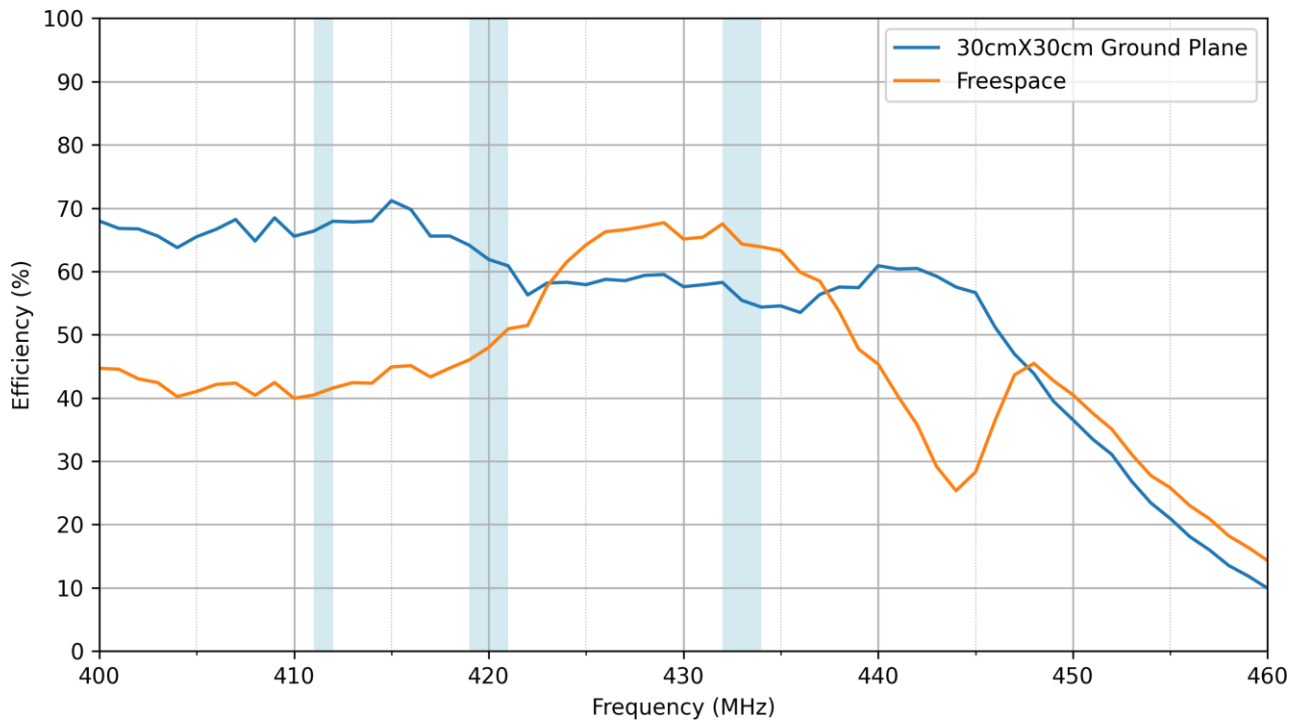

### 3.5 Average Gain

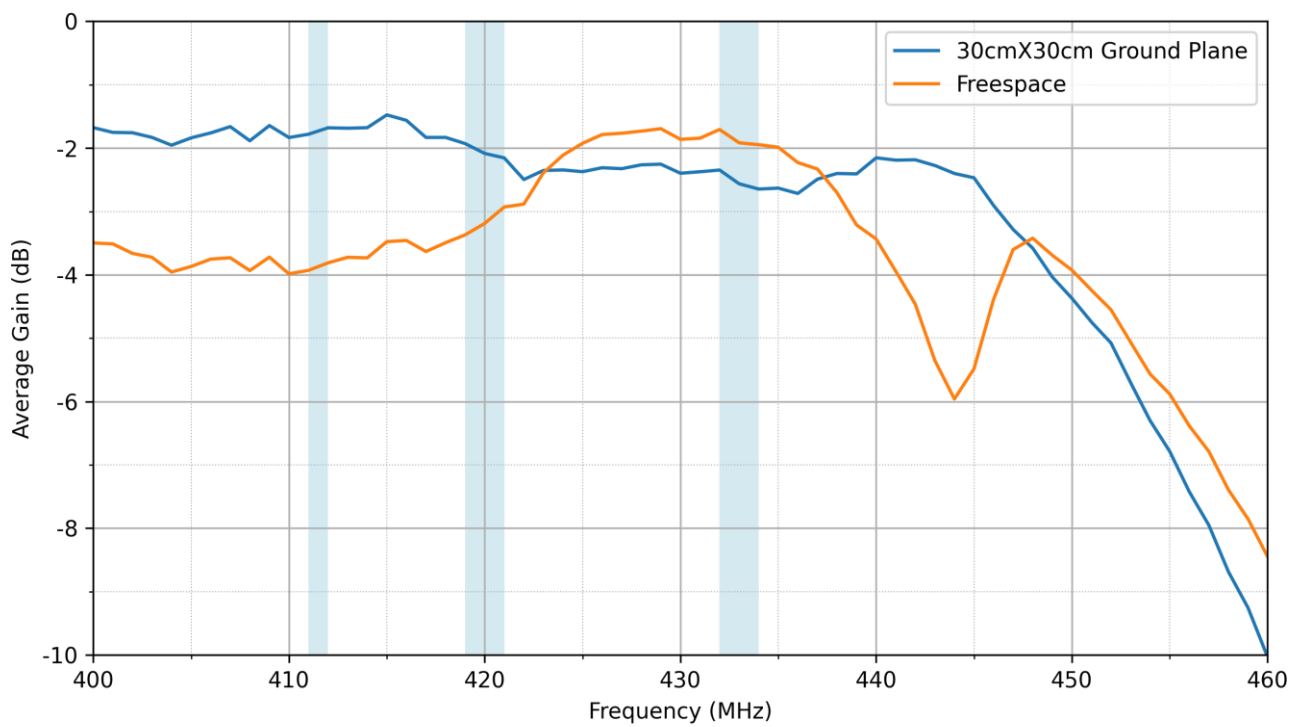

### 3.6 Peak Gain

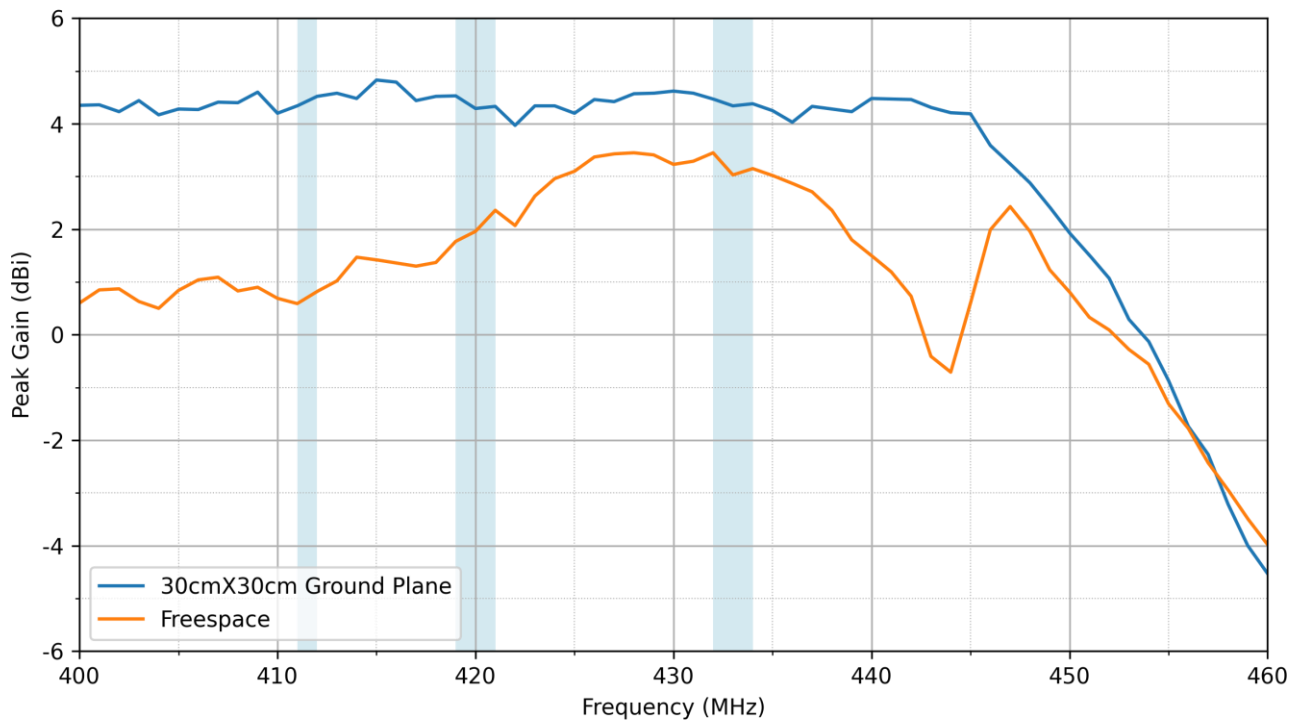



## 4. Radiation Patterns

### 4.1 Test Setup

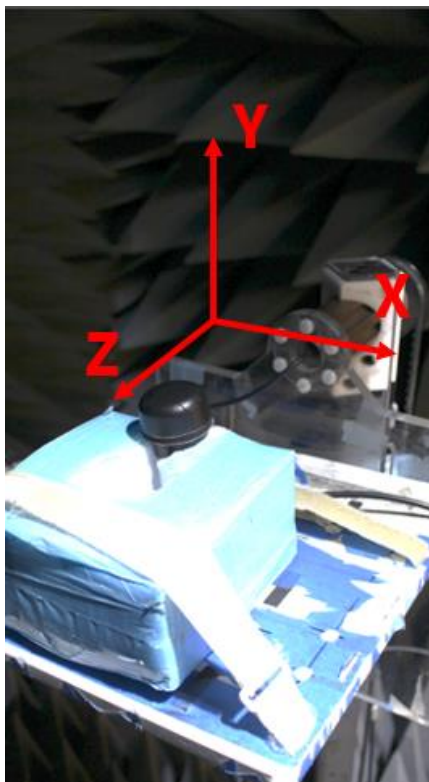
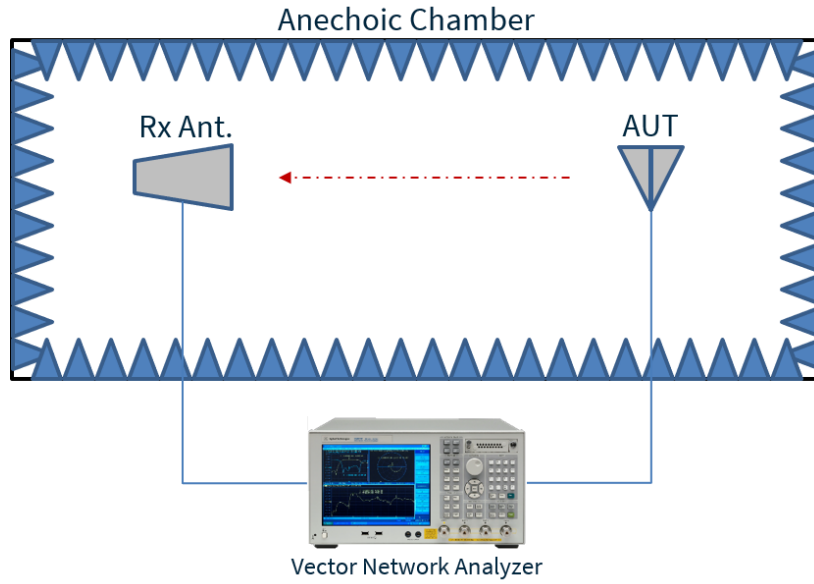

Free Space

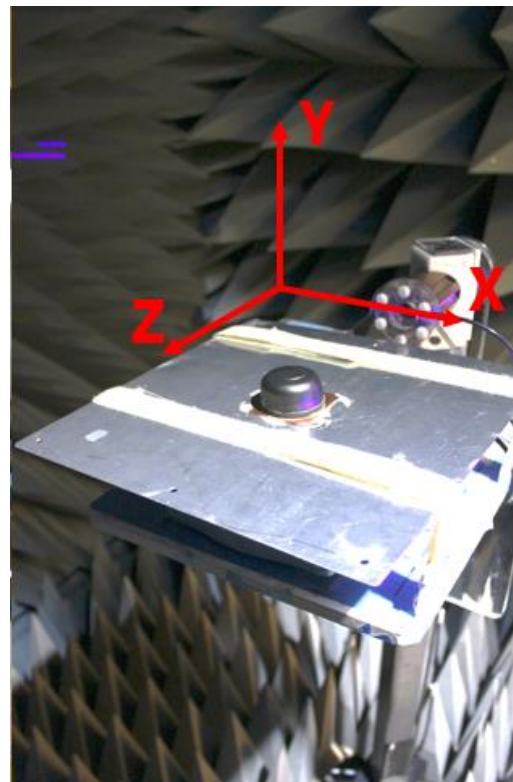

30x30cm Ground Plane

4.2 30cmX30cm Ground Plane Patterns at 410 MHz

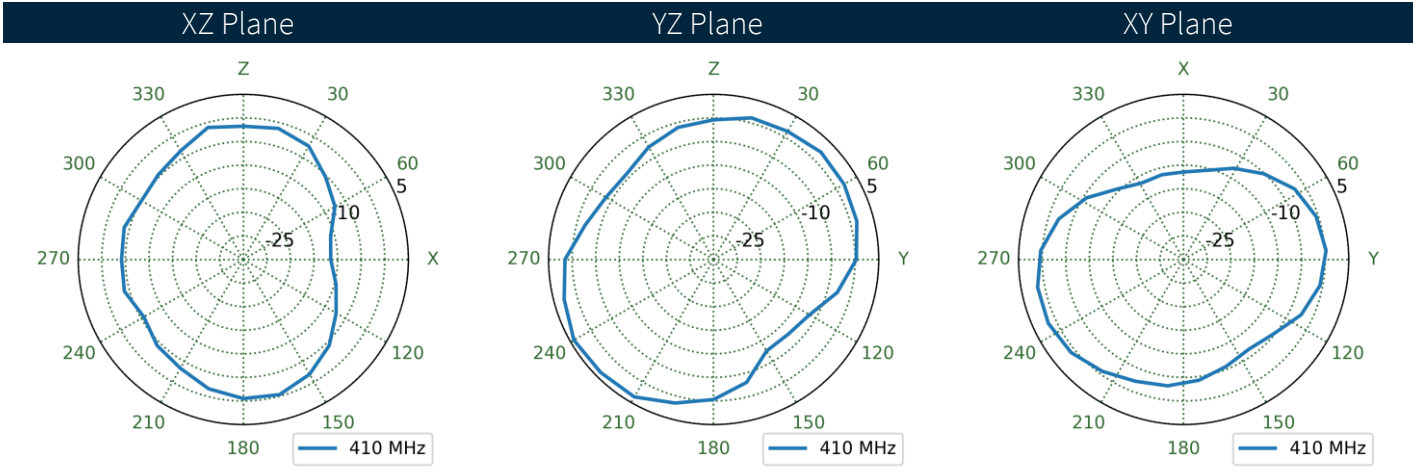
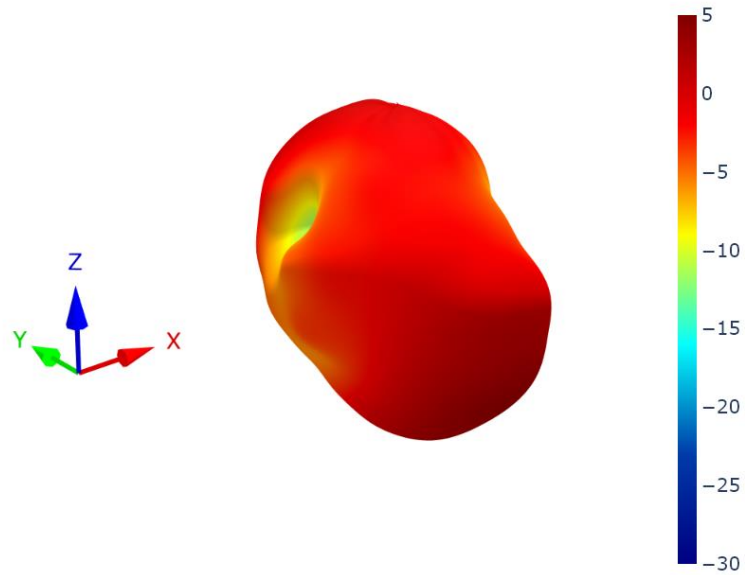

4.3 Freespace Patterns at 410 MHz

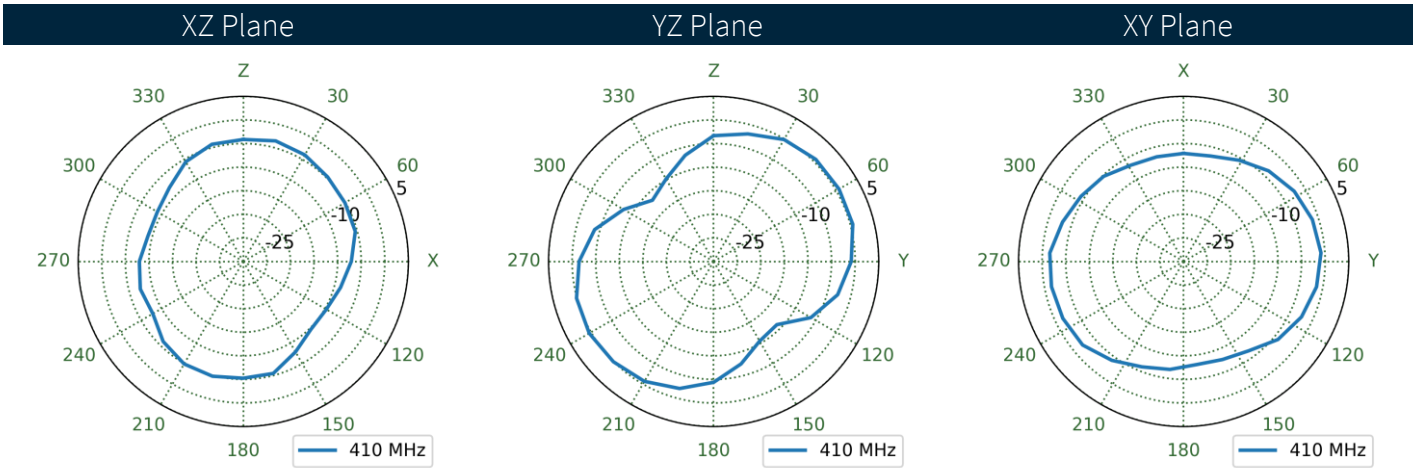
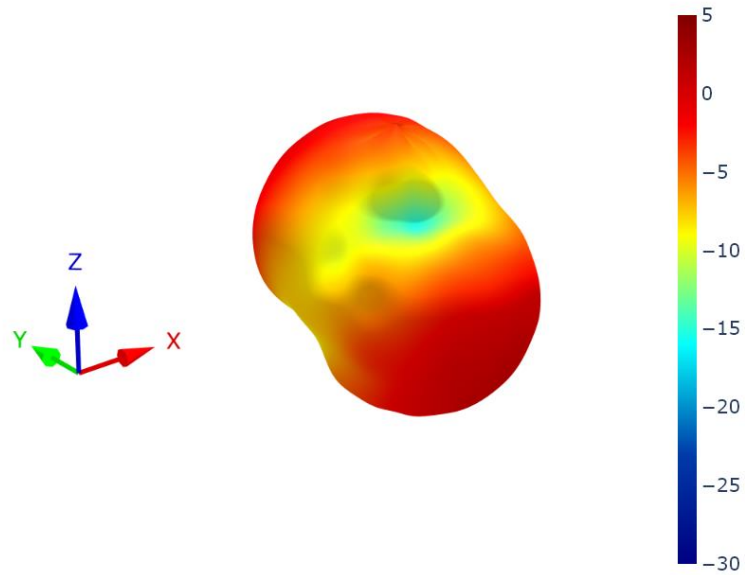

4.4 30cmX30cm Ground Plane Patterns at 411 MHz

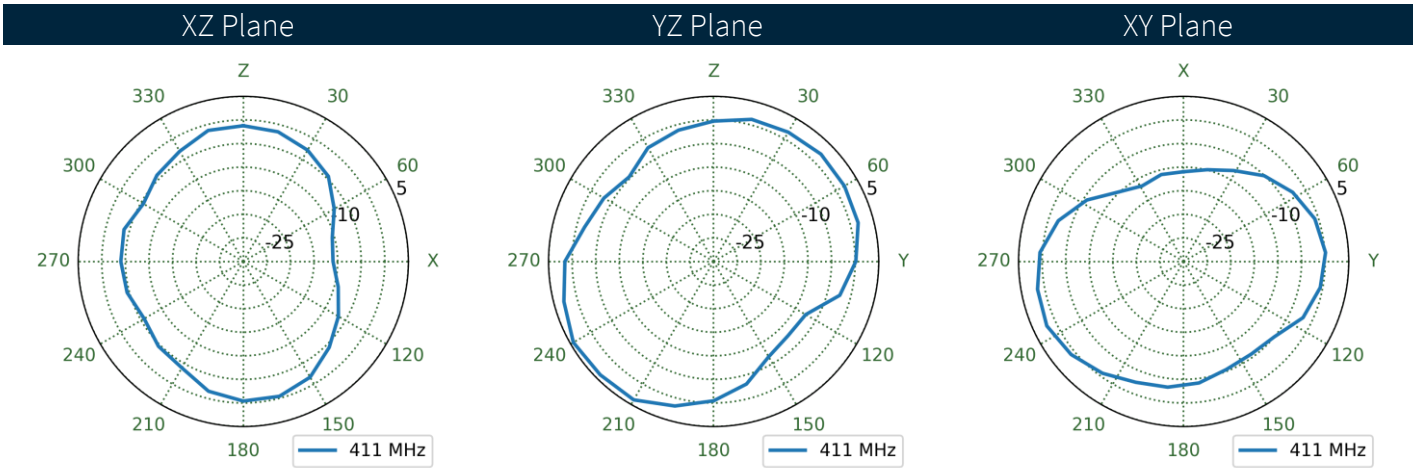
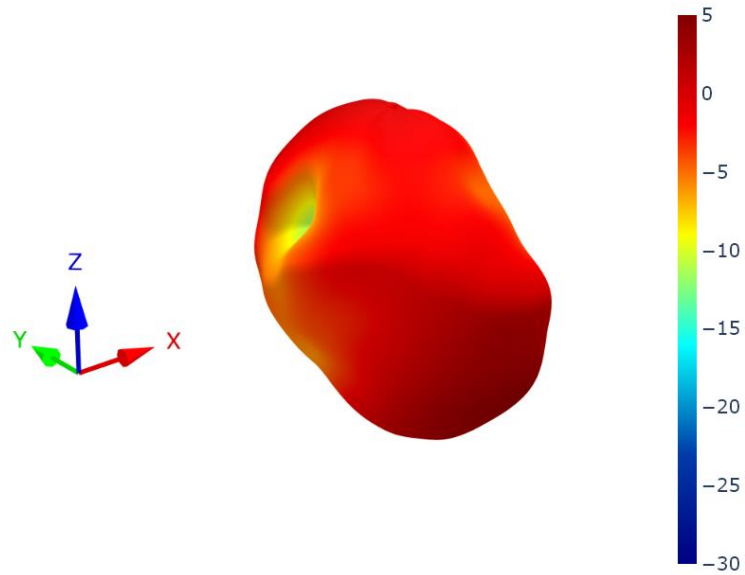

4.5 Freespace Patterns at 411 MHz

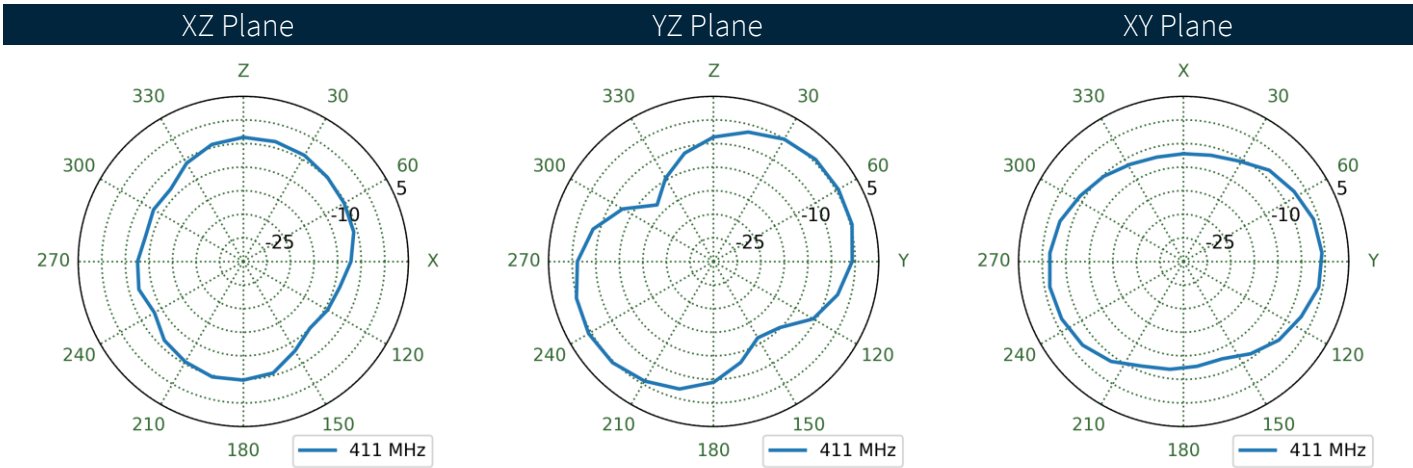
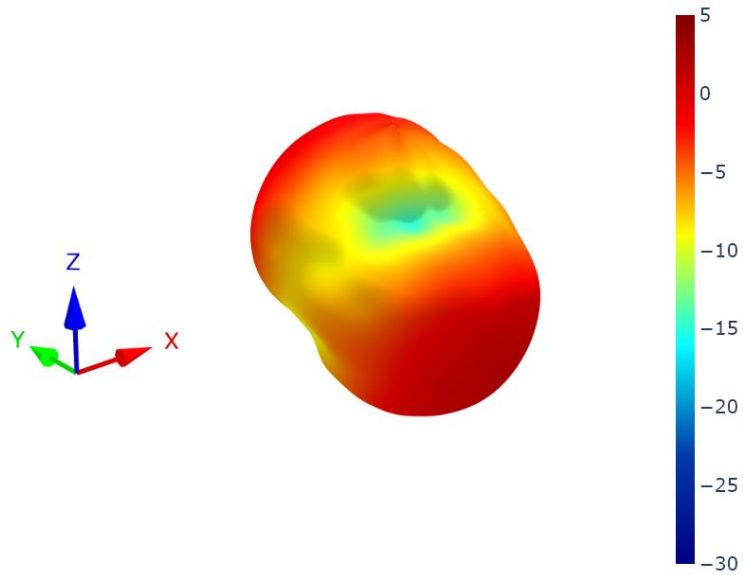

4.6 30cmX30cm Ground Plane Patterns at 414 MHz

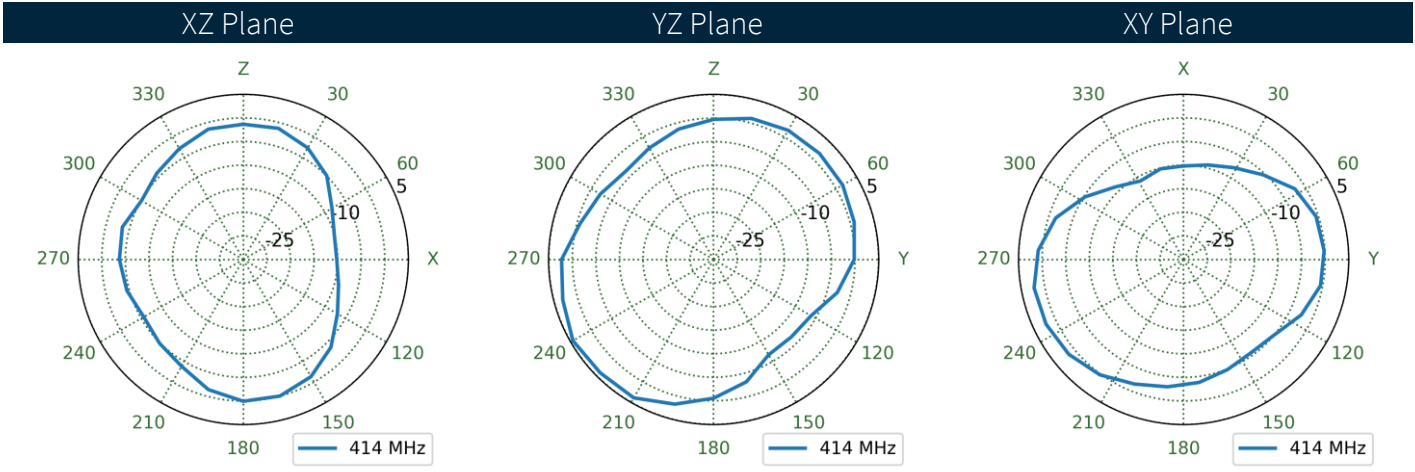
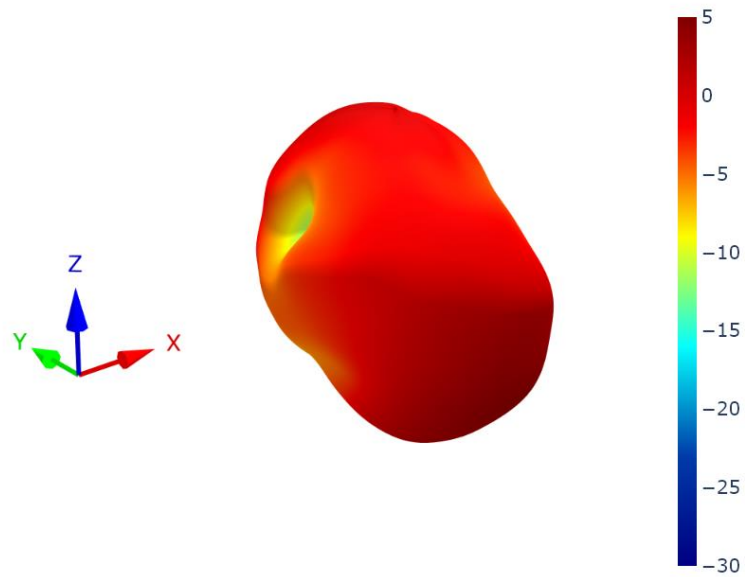

4.7 Freespace Patterns at 414 MHz

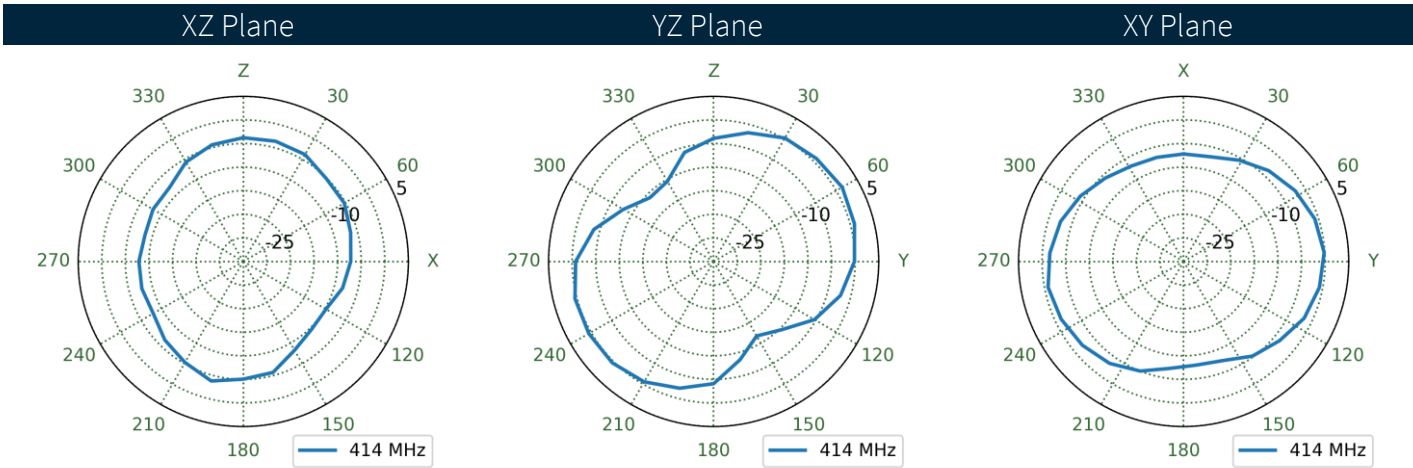
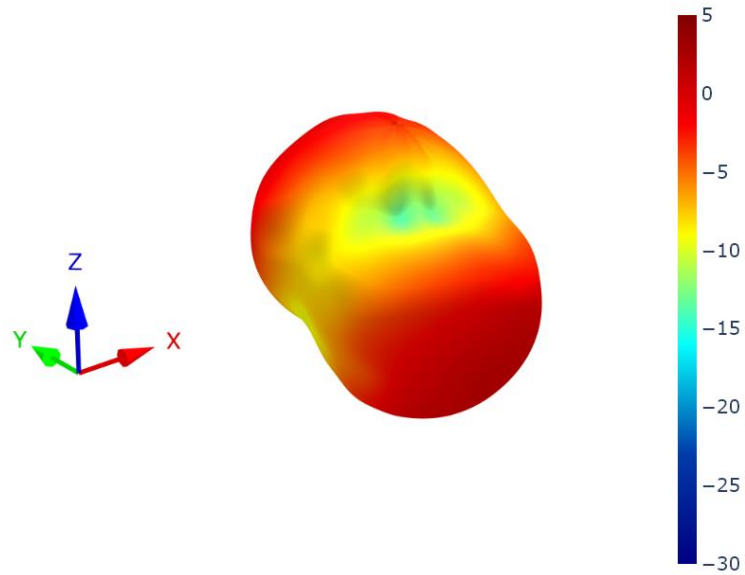

4.8 30cmX30cm Ground Plane Patterns at 415 MHz

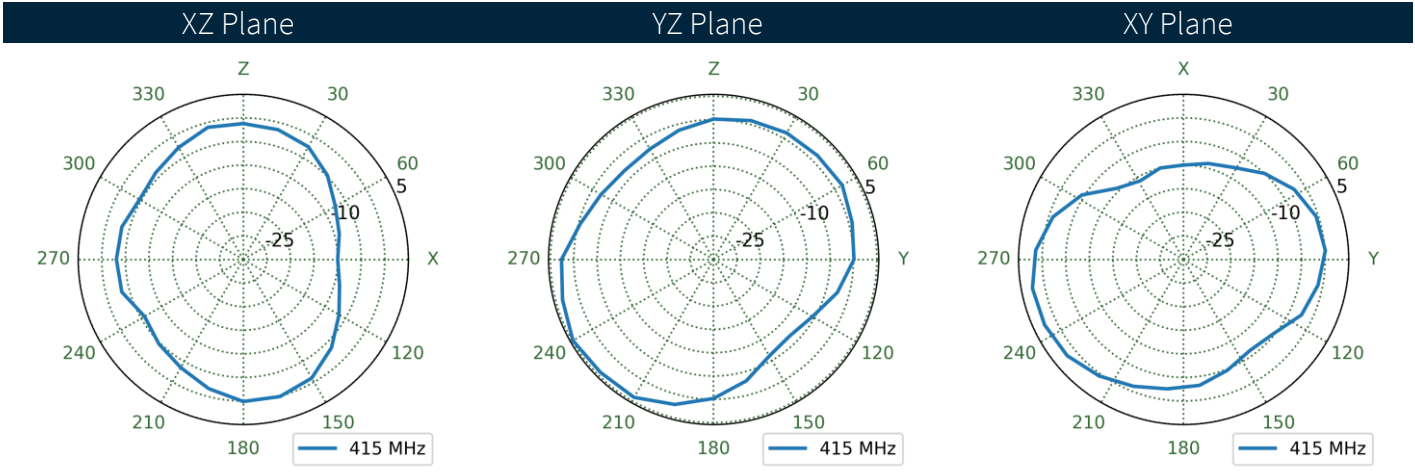
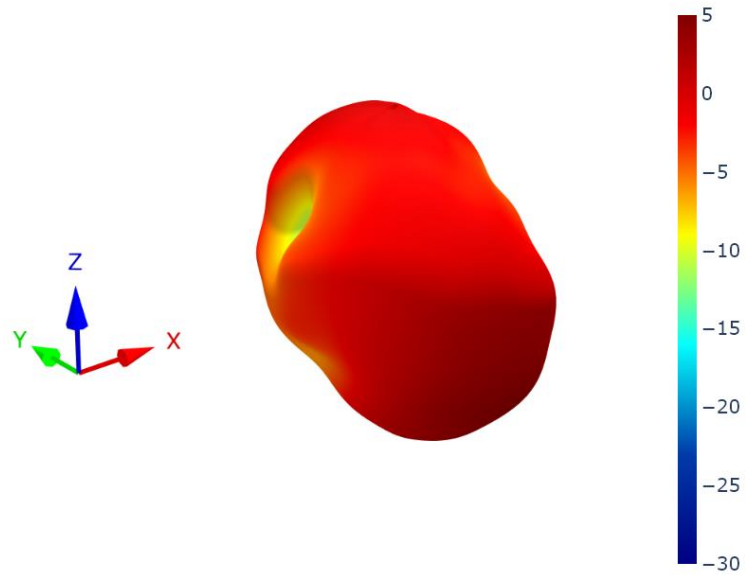



4.9 Freespace Patterns at 415 MHz

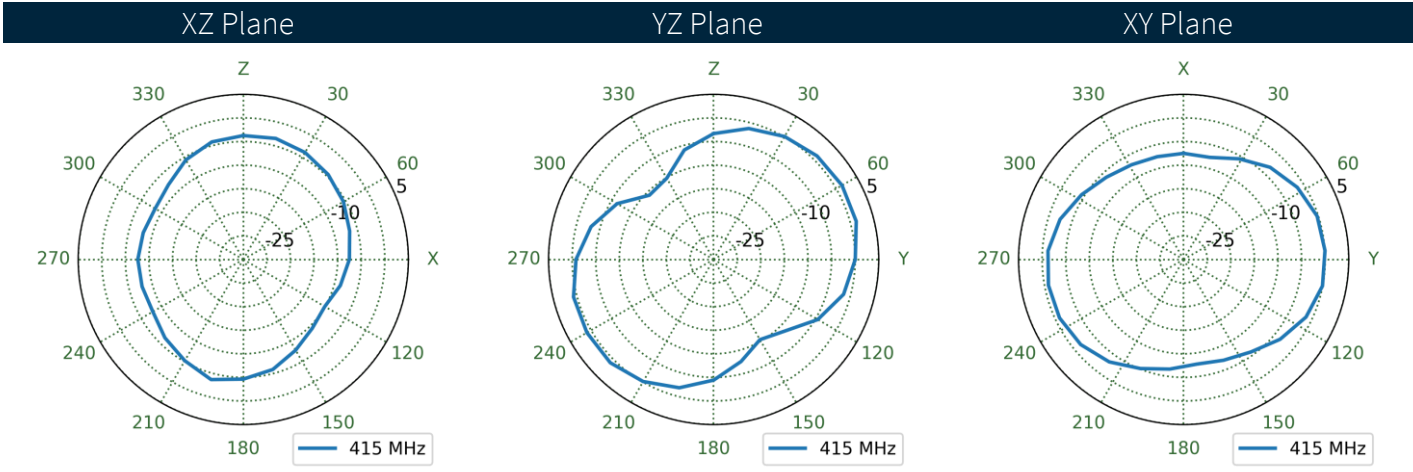
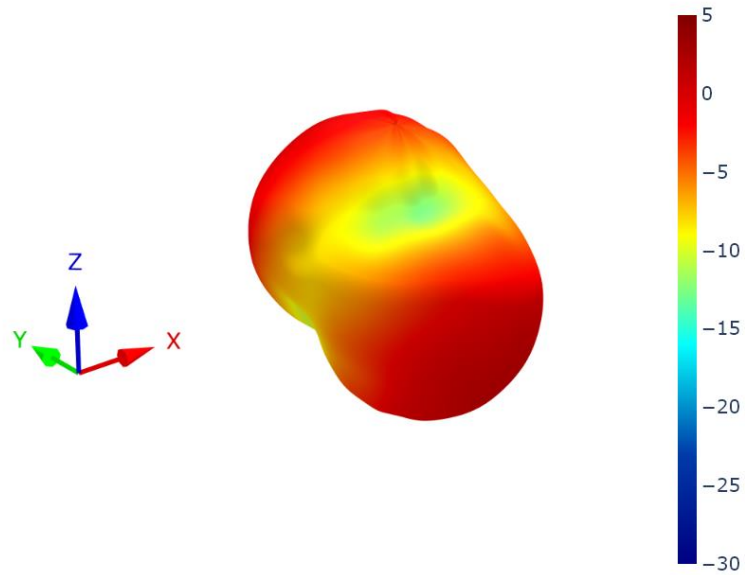

4.10 30cmX30cm Ground Plane Patterns at 420 MHz

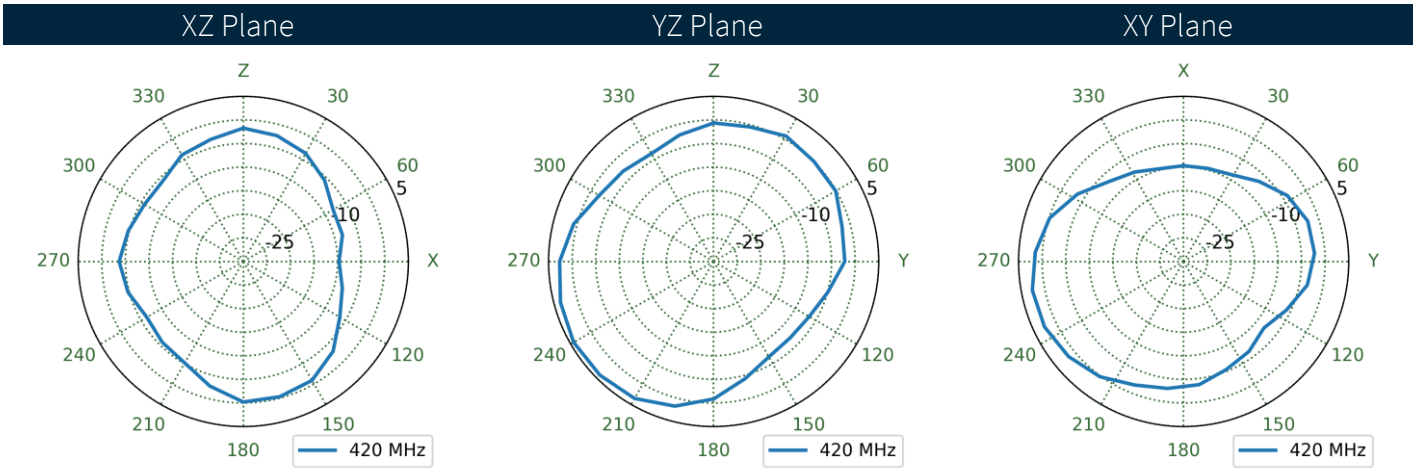
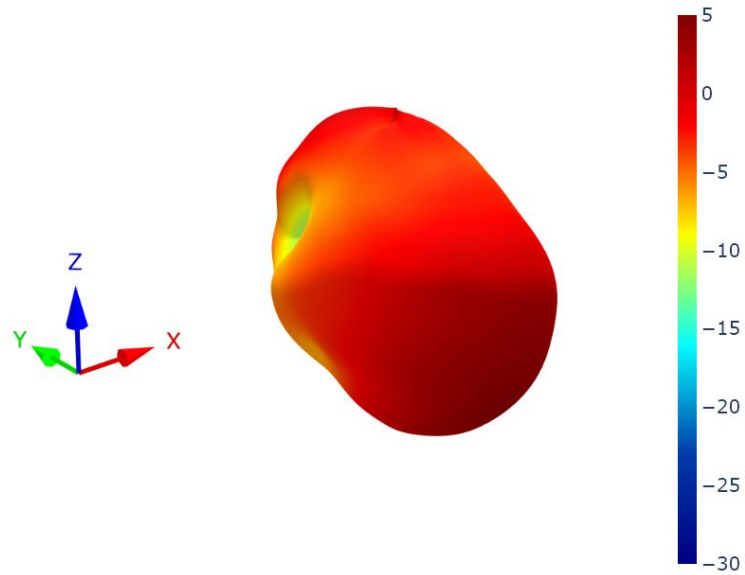

4.11 Freespace Patterns at 420 MHz

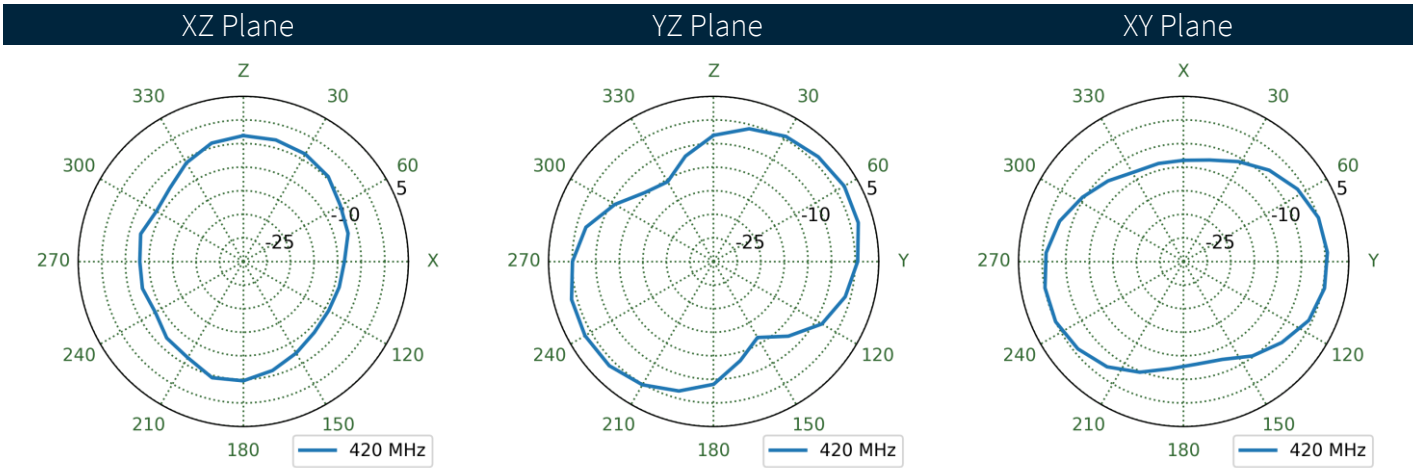
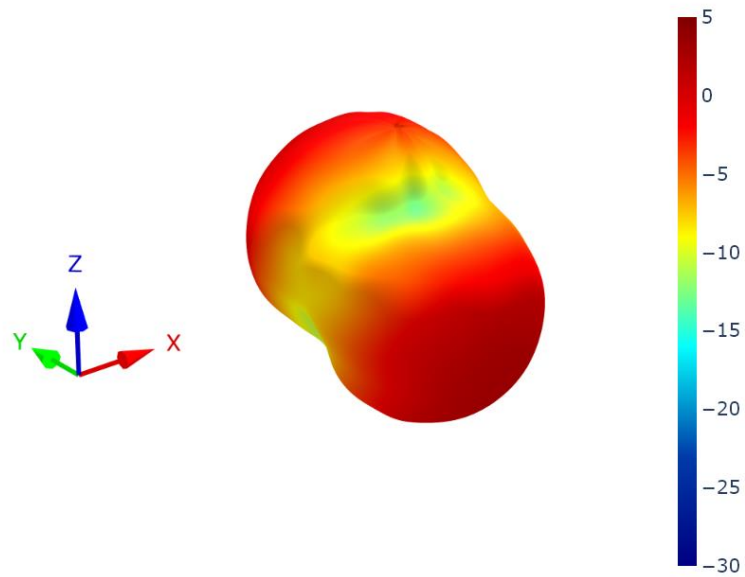

4.12 30cmX30cm Ground Plane Patterns at 424 MHz

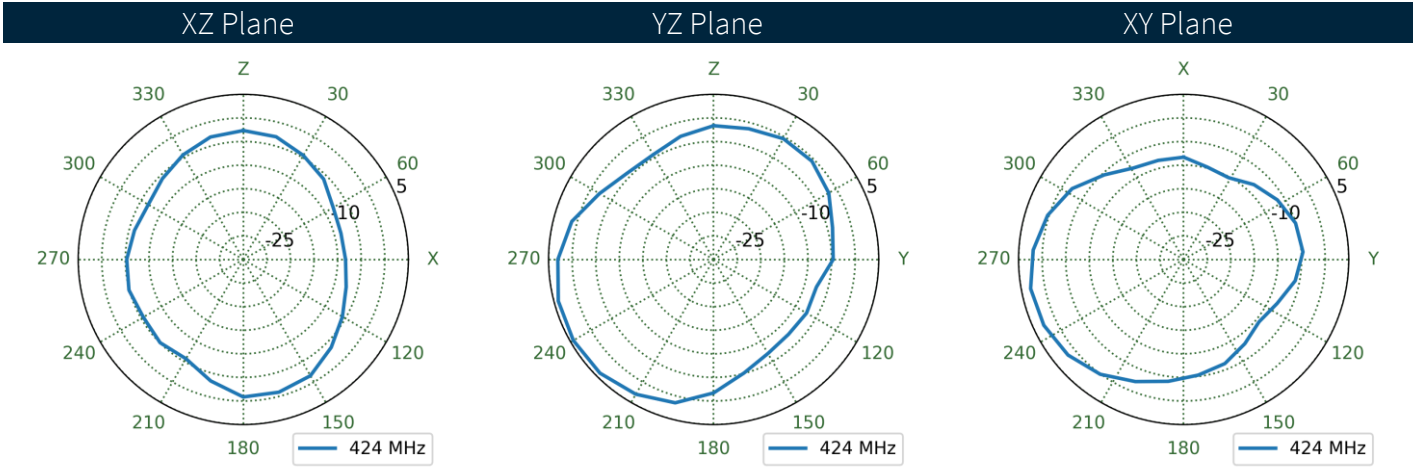
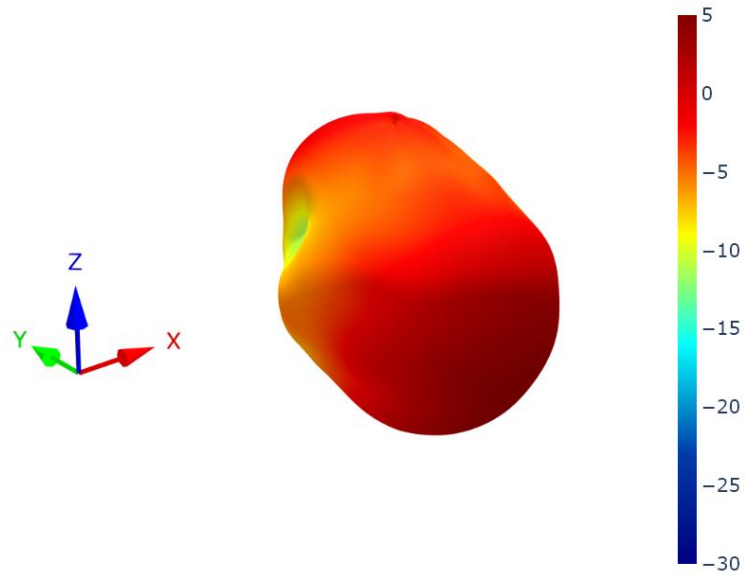

4.13 Freespace Patterns at 424 MHz

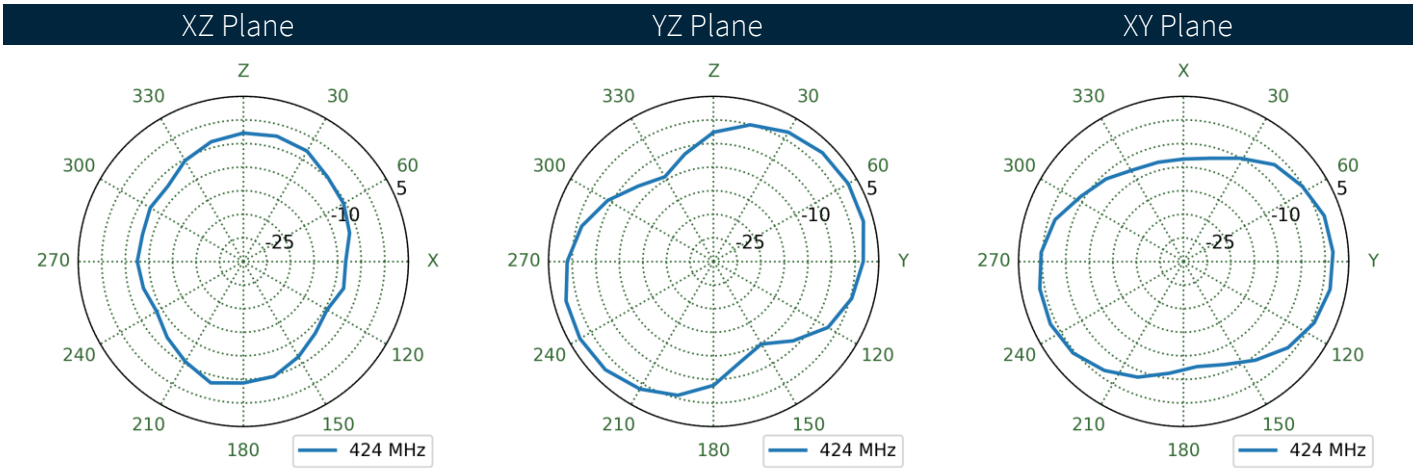
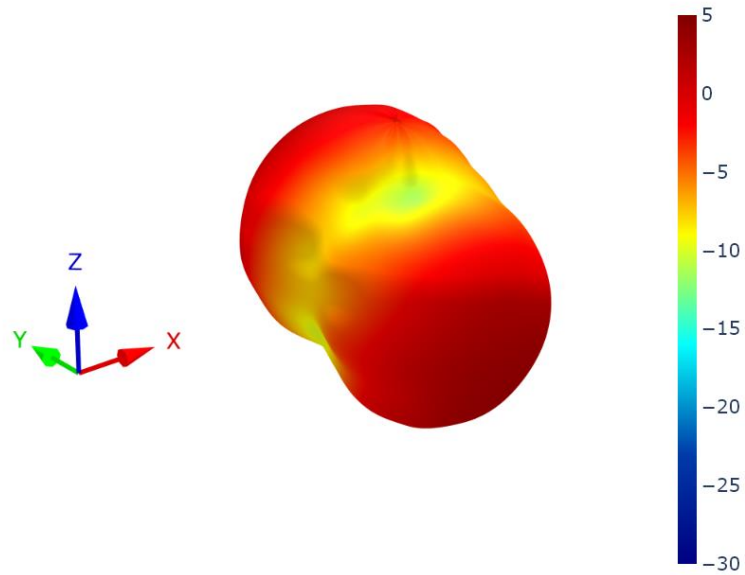

4.14 30cmX30cm Ground Plane Patterns at 433 MHz

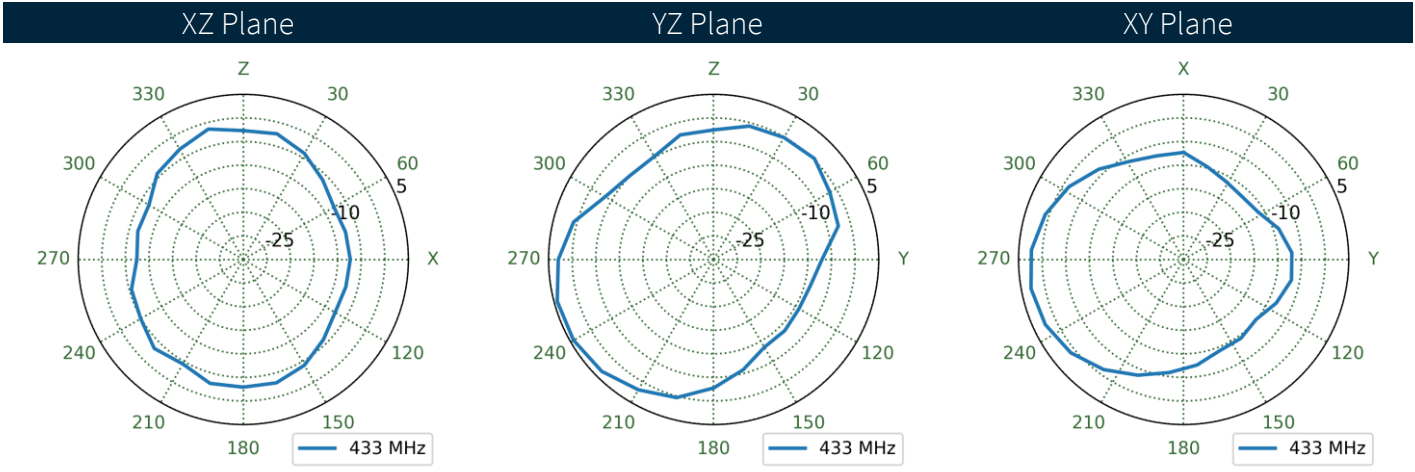
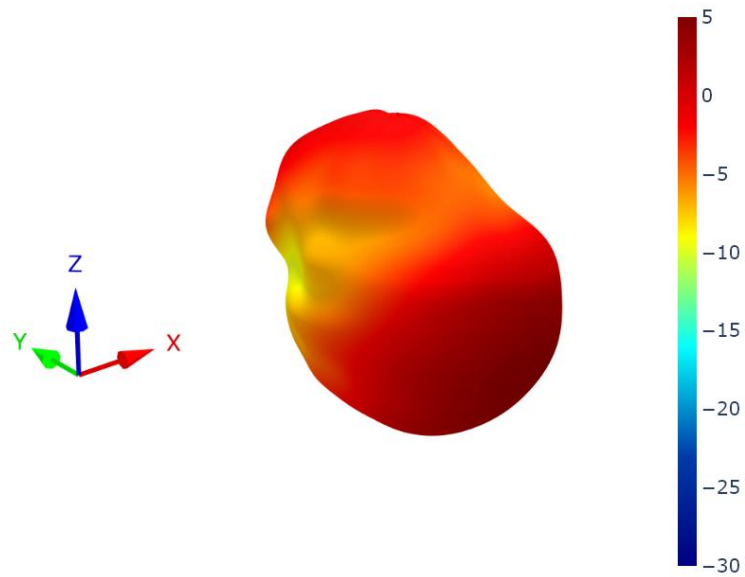

4.15 Freespace Patterns at 433 MHz

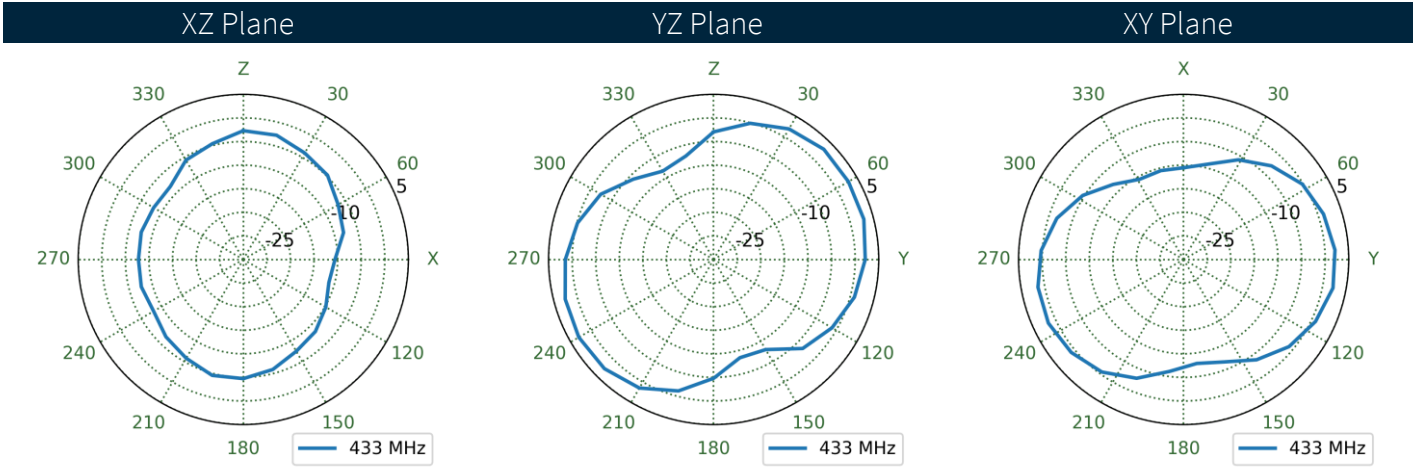
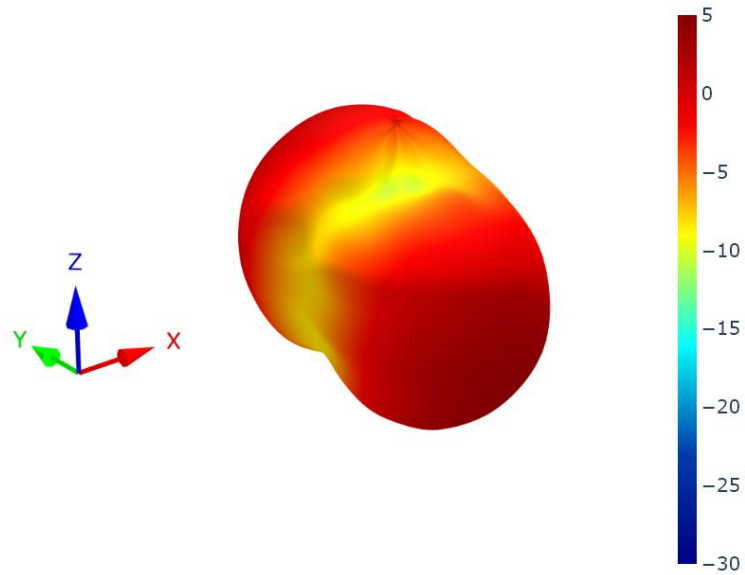

# 5. Mechanical Drawing

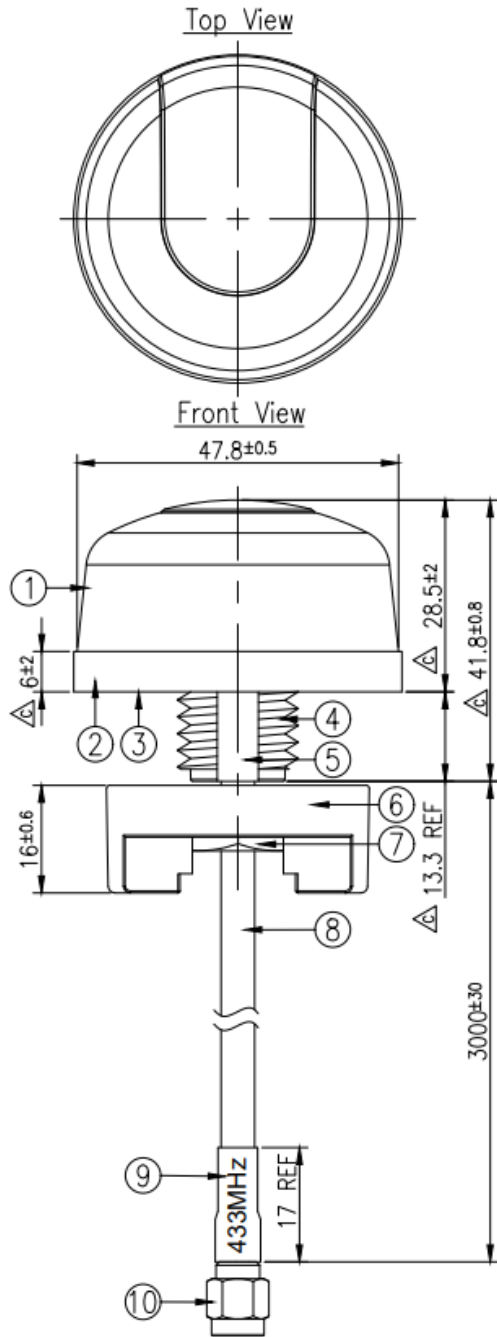

Bottom Thread View

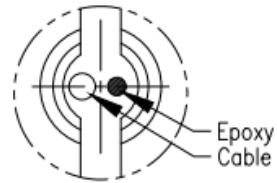

Side View

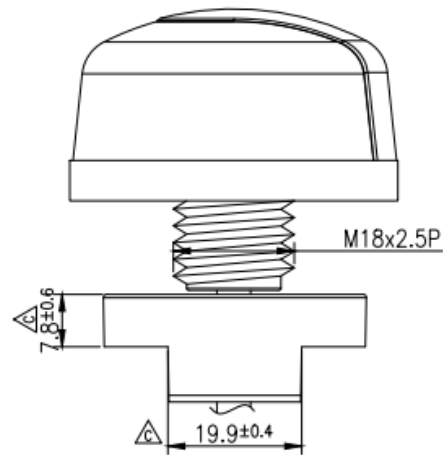

	Name	Finish	QTY
1	Housing	Black	1
2	Closed Cell Foam	Black	1
3	3M Double Adhesive	White Liner	1
4	Metal Base	Ni Plated	1
5	Rubber Stopper	Black	1
6	Outer Nut Cover	Black	1
7	M18 Inner Nut Cut	Zn Plated	1
8	CFD200 Coaxial Cable	Black	1
9	Heat Shrink Tube(433 MHz)	Yellow Tube/Black Text	1
10	SMA(M)ST	Au Plated	1



## 6. Installation

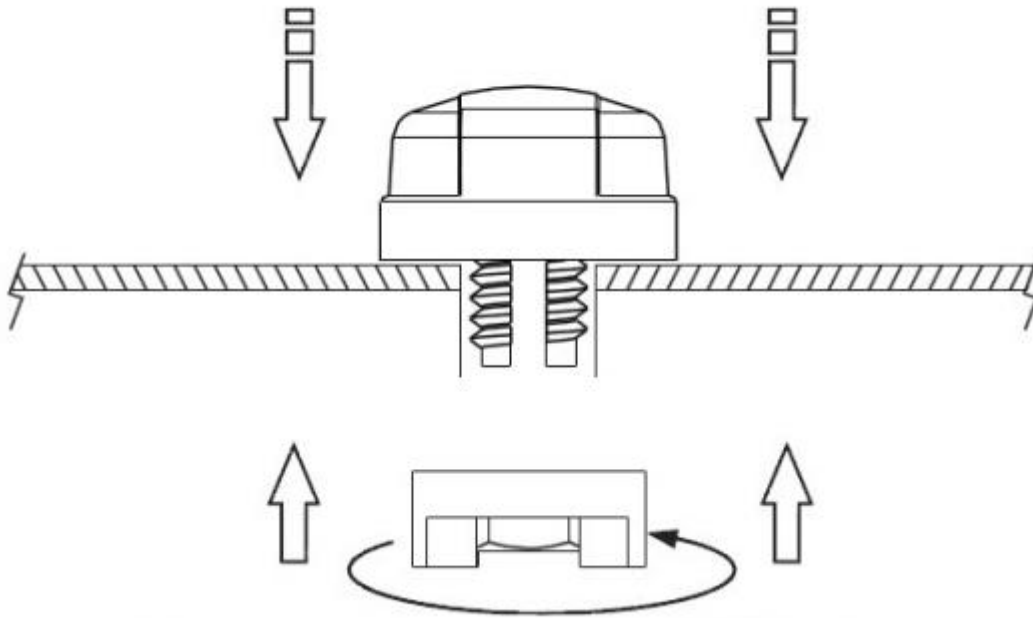

*Hand Tighten Only*

## 7. Packaging

1 pcs IS.01.B.305111 per PE Bag  
 Bag Dimensions - 280 x 180 mm  
 Weight - 214g

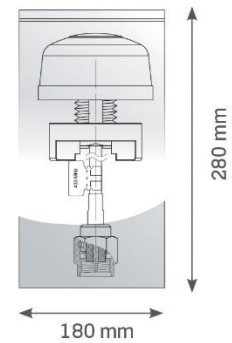

10 pcs IS.01.B.305111 per PE Large Bag  
 Bag Dimensions - 520x 360mm  
 Weight - 2.2kg

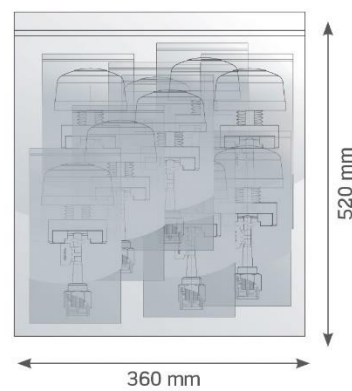

50 pcs IS.01.B.305111 per carton  
 Carton - 430 x 380 x 280mm  
 Weight - 11.3Kg

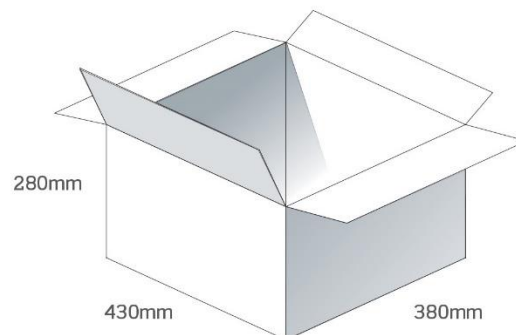

Pallet Dimensions 120x 100 x 132cm  
 24 Cartons per Pallet  
 6 Cartons per layer  
 4 Layers

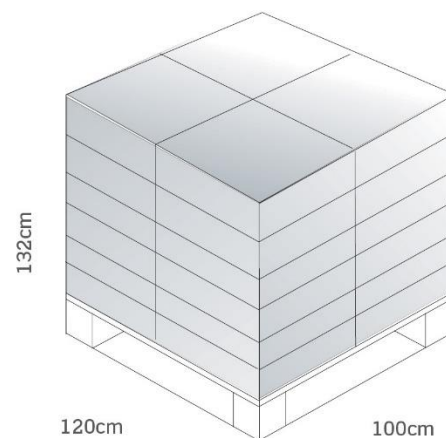

Changelog for the datasheet

**SPE-13-8-004– IS.01.B.305111**

**Revision: I (Current Version)**

Date:	2023-08-04
Changes:	Updated data
Changes Made by:	Gary West

**Previous Revisions**

**Revision: H**

Date:	2023-07-25
Changes:	Updated Antenna Specifications Updated Radiation Patterns
Changes Made by:	Aswin Biju

**Revision: C**

Date:	2014-09-25
Changes:	changed to NFC200
Changes Made by:	AINE DOYLE

**Revision: G (Current Version)**

Date:	2021-11-18
Changes:	Format Change, MSL
Changes Made by:	Erik Landi

**Revision: B**

Date:	2013-02-06
Changes:	
Changes Made by:	STAFF

**Revision: F**

Date:	2021-02-09
Changes:	
Changes Made by:	Jack Conroy

**Revision: A (Original First Release)**

Date:	2012-01-21
Notes:	Initial Release
Author:	STAFF

**Revision: E**

Date:	NA
Changes:	
Changes Made by:	STAFF

**Revision: D**

Date:	2016-12-23
Changes:	Updated with revised salt spray info and disclaimer
Changes Made by:	Andy Mahoney



[www.taoglas.com](http://www.taoglas.com)



# Mouser Electronics

Authorized Distributor

Click to View Pricing, Inventory, Delivery & Lifecycle Information:

[Taoglas:](#)

[IS.01.B.305111](#)