

Notice for TAIYO YUDEN products

Please read this notice before using the TAIYO YUDEN products.

REMINDERS

- Product information in this catalog is as of October 2009. All of the contents specified herein are subject to change without notice due to technical improvements, etc. Therefore, please check for the latest information carefully before practical application or usage of the Products.

Please note that Taiyo Yuden Co., Ltd. shall not be responsible for any defects in products or equipment incorporating such products, which are caused under the conditions other than those specified in this catalog or individual specification.

- Please contact Taiyo Yuden Co., Ltd. for further details of product specifications as the individual specification is available.
- Please conduct validation and verification of products in actual condition of mounting and operating environment before commercial shipment of the equipment.

- All electronic components or functional modules listed in this catalog are developed, designed and intended for use in general electronics equipment.(for AV, office automation, household, office supply, information service, telecommunications, (such as mobile phone or PC) etc.). Before incorporating the components or devices into any equipment in the field such as transportation,(automotive control, train control, ship control), transportation signal, disaster prevention, medical, public information network (telephone exchange, base station) etc. which may have direct influence to harm or injure a human body, please contact Taiyo Yuden Co., Ltd. for more detail in advance. Do not incorporate the products into any equipment in fields such as aerospace, aviation, nuclear control, submarine system, military, etc. where higher safety and reliability are especially required.

In addition, even electronic components or functional modules that are used for the general electronic equipment, if the equipment or the electric circuit require high safety or reliability function or performances, a sufficient reliability evaluation check for safety shall be performed before commercial shipment and moreover, due consideration to install a protective circuit is strongly recommended at customer's design stage.

- The contents of this catalog are applicable to the products which are purchased from our sales offices or distributors (so called "TAIYO YUDEN' s official sales channel"). It is only applicable to the products purchased from any of TAIYO YUDEN' s official sales channel.

- Please note that Taiyo Yuden Co., Ltd. shall have no responsibility for any controversies or disputes that may occur in connection with a third party's intellectual property rights and other related rights arising from your usage of products in this catalog. Taiyo Yuden Co., Ltd. grants no license for such rights.

- Caution for export

Certain items in this catalog may require specific procedures for export according to "Foreign Exchange and Foreign Trade Control Law" of Japan, "U.S. Export Administration Regulations", and other applicable regulations. Should you have any question or inquiry on this matter, please contact our sales staff.
Should you have any question or inquiry on this matter, please contact our sales staff.

SMD INDUCTORS LOW PROFILE TYPE



REFLOW

FEATURES

- Small and Low profile inductor.
- It corresponds to High current.
- Simple and original magnetic shield structure.
- Durable structure against dropping impact.

APPLICATIONS

- For small DC/DC converter (cellular Phone, HDD, DVC, DSC, PDA, LCD display etc).

ORDERING CODE

N
R
△
4
0
1
8
T
△
1
0
0
M
△

1 Type

NR△, NRG Coating resin specification
△=Blank Space

3 Packaging

T△ Tape & Reel
△=Blank Space

4 Nominal inductance [μH]

example	
2R2	2.2
100	10
101	100

※R=decimal point

5 Inductance tolerance

M	±20%
N	±30%

6 Internal code

△ Standard product
△=Blank Space

example	4026		5040	
3010	3.0×3.0×1.0mm	5040	5.0×5.0×4.0mm	
3012	3.0×3.0×1.2mm	6012	6.0×6.0×1.2mm	
3015	3.0×3.0×1.5mm	6020	6.0×6.0×2.0mm	
4010	4.0×4.0×1.0mm	6028	6.0×6.0×2.8mm	
4012	4.0×4.0×1.2mm	6045	6.0×6.0×4.5mm	
4018	4.0×4.0×1.8mm	8040	8.0×8.0×4.0mm	

EXTERNAL DIMENSIONS/STANDARD QUANTITY

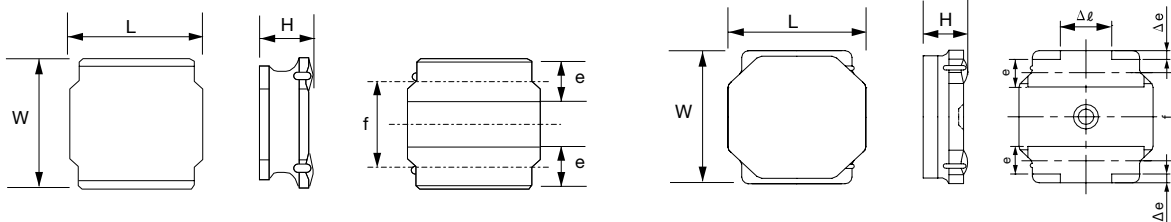

Type	L	W	H	e	f	Standard Quantity [pcs] Tape & Reel
NR3010	3.0±0.1 (0.118±0.004)	3.0±0.1 (0.118±0.004)	1.0 max (0.039 max)	0.9±0.2 (0.035±0.008)	1.9±0.2 (0.075±0.008)	2000
NR3012			1.2 max (0.047 max)			
NR3015			1.5 max (0.059 max)			
NR4010	4.0±0.2 (0.157±0.008)	4.0±0.2 (0.157±0.008)	1.0 max (0.039 max)	1.1±0.2 (0.043±0.008)	2.5±0.2 (0.098±0.008)	5000
NR4012			1.2 max (0.047 max)			4500
NR4018			1.8 max (0.071 max)			3500
NRG4026			2.6 max (0.102 max)			2000
NR8040	8.0±0.2 (0.315±0.008)	8.0±0.2 (0.315±0.008)	⁺¹⁾ 4.2max (0.165max) ⁺²⁾ 4.0max (0.157max)	1.6±0.3 (0.063±0.012)	5.6±0.3 (0.220±0.012)	1000

*1) 0R9~6R8 Type
*2) 100~101 Type

Unit : mm (inch)

Type	L	W	H	e	Δe	f	Δφ	Standard Quantity [pcs] Tape & Reel
NR5040	4.9±0.2 (0.193±0.008)	4.9±0.2 (0.193±0.008)	⁺³⁾ 4.1max (0.161max) ⁺⁴⁾ 4.0max (0.157max)	1.2±0.2 (0.047±0.008)	0.3±0.2 (0.011±0.008)	3.3±0.2 (0.130±0.008)	1.3±0.3 (0.051±0.011)	1500
NR6012 (E Type)	6.0±0.2 (0.236±0.008)	6.0±0.2 (0.236±0.008)	1.2 max (0.047 max)	1.35±0.2 (0.053±0.008)	0.3±0.2 (0.011±0.008)	4.0±0.2 (0.157±0.008)	2.3±0.3 (0.091±0.011)	1000
NR6020	6.0±0.2 (0.236±0.008)	6.0±0.2 (0.236±0.008)	2.0 max (0.078 max)	1.35±0.2 (0.053±0.008)	0.3±0.2 (0.011±0.008)	4.0±0.2 (0.157±0.008)		2500
NR6028	6.0±0.2 (0.236±0.008)	6.0±0.2 (0.236±0.008)	2.8 max (0.110 max)	1.35±0.2 (0.053±0.008)	0.3±0.2 (0.011±0.008)	4.0±0.2 (0.157±0.008)		2000
NR6045	6.0±0.2 (0.236±0.008)	6.0±0.2 (0.236±0.008)	4.5 max (0.177 max)	1.35±0.2 (0.053±0.008)	0.3±0.2 (0.011±0.008)	4.0±0.2 (0.157±0.008)		1500

*3) 1R5~100 Type

*4) 150~470 Type

Unit : mm (inch)

* This catalog contains the typical specification only due to the limitation of space. When you consider purchase of our products, please check our specification. For details of each product (characteristics graph, reliability information, precautions for use, and so on), see our Web site (<http://www.ty-top.com/>) or CD catalogs.

Recommended Land Patterns

[NR3010, NR3012, NR3015]

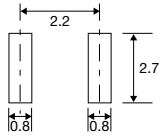

[NR4010, NR4012, NR4018, NRG4026]

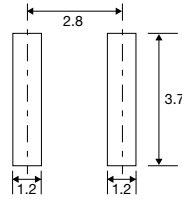

[NR5040]

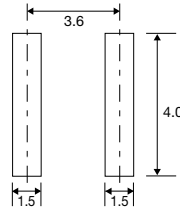

[NR6012, NR6020, NR6028, NR6045]

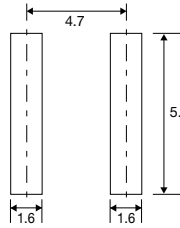

[NR8040]

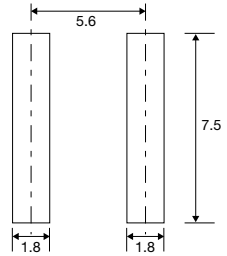

Unit : mm

AVAILABLE INDUCTANCE RANGE

Range	Type	NR 3010		NR 3012		NR 3015		NR 4010		NR 4012		NR 4018		NR 5040		NR 6012		NR 6020		NR 6028		NR 6045		NR 8040		NRG 4026		
		IMAX [mA]	Rdc±20% [Ω]	IMAX [mA]	Rdc±20% [Ω]	IMAX [mA]	Rdc±20% [Ω]	IMAX [mA]	Rdc±20% [Ω]	IMAX [mA]	Rdc±20% [Ω]	IMAX [mA]	Rdc±20% [Ω]	IMAX [mA]	Rdc±20% [Ω]	IMAX [mA]	Rdc±20% [Ω]	IMAX [mA]	Rdc±20% [Ω]	IMAX [mA]	Rdc±20% [Ω]	IMAX [mA]	Rdc±20% [Ω]	IMAX [mA]	Rdc±20% [Ω]	IMAX [mA]	Rdc±20% [Ω]	
0.8		1300	0.065	1490	0.05	2100	0.030	1050	0.100	1500	0.060	1830	0.030															
3.3														3600	0.020													
10		500	0.450	540	0.290	700	0.230	560	0.380	740	0.240	840	0.180	2100	0.056	1000	0.235	1400	0.125	1900	0.065	2500	0.047	3100	0.034	1300	0.085	
47		220	2.05	250	1.45	300	1.34	240	1.81	350	1.00			900	0.310			950	0.290									
100																												
220												170	4.00			320	2.18			620	0.600	700	0.500	1000	0.290			

PART NUMBERS

NR 3010 Shielded type

Ordering code	EHS (Environmental Hazardous Substances)	Inductance [μH]	Inductance Tolerance	Self-resonant frequency [MHz] (min.)	DC Resistance [Ω] (±20%)	Rated current ※) [mA]		Measuring frequency [kHz]
						Saturation current I _{dc1}	Temperature rise current I _{dc2}	
NR 3010T 1R0N	RoHS	1.0	±30%	126	0.065	1,300	1,400	100
NR 3010T 1R5N	RoHS	1.5		98	0.080	1,200	1,300	
NR 3010T 2R2M	RoHS	2.2		82	0.095	1,100	1,100	
NR 3010T 3R3M	RoHS	3.3	63	0.140	870	940		
NR 3010T 4R7M	RoHS	4.7	56	0.190	750	780		
NR 3010T 6R8M	RoHS	6.8	46	0.300	610	630		
NR 3010T 100M	RoHS	10	±20%	35	0.450	500	510	
NR 3010T 150M	RoHS	15		30	0.740	400	400	
NR 3010T 220M	RoHS	22		25	1.03	350	350	
NR 3010T 330M	RoHS	33		20	1.55	260	275	
NR 3010T 470M	RoHS	47		17	2.05	220	235	

NR 3012 Shielded type

Ordering code	EHS (Environmental Hazardous Substances)	Inductance [μH]	Inductance Tolerance	Self-resonant frequency [MHz] (min.)	DC Resistance [Ω] (±20%)	Rated current ※) [mA]		Measuring frequency [kHz]
						Saturation current I _{dc1}	Temperature rise current I _{dc2}	
NR 3012T 1R0N	RoHS	1.0	±30%	110	0.050	1,500	1,490	100
NR 3012T 1R5N	RoHS	1.5		92	0.060	1,360	1,400	
NR 3012T 2R2M	RoHS	2.2		70	0.080	1,100	1,200	
NR 3012T 3R3M	RoHS	3.3	55	0.100	910	1,050		
NR 3012T 4R7M	RoHS	4.7	48	0.130	770	980		
NR 3012T 6R8M	RoHS	6.8	40	0.190	670	740		
NR 3012T 100M	RoHS	10	±20%	32	0.290	540	630	
NR 3012T 150M	RoHS	15		27	0.450	440	485	
NR 3012T 220M	RoHS	22		22	0.630	375	420	
NR 3012T 330M	RoHS	33		19	1.03	310	330	
NR 3012T 470M	RoHS	47		17	1.45	250	280	

NR 3015 Shielded type

Ordering code	EHS (Environmental Hazardous Substances)	Inductance [μH]	Inductance Tolerance	Self-resonant frequency [MHz] (min.)	DC Resistance [Ω] (±20%)	Rated current ※) [mA]		Measuring frequency [kHz]
						Saturation current I _{dc1}	Temperature rise current I _{dc2}	
NR 3015T 1R0N	RoHS	1.0	±30%	100	0.030	2,100	2,100	100
NR 3015T 1R5N	RoHS	1.5		87	0.040	1,800	1,820	
NR 3015T 2R2M	RoHS	2.2		64	0.060	1,480	1,500	
NR 3015T 3R3M	RoHS	3.3	49	0.080	1,210	1,230		
NR 3015T 4R7M	RoHS	4.7	40	0.120	1,020	1,040		
NR 3015T 6R8M	RoHS	6.8	36	0.160	870	880		
NR 3015T 100M	RoHS	10	±20%	28	0.230	700	710	
NR 3015T 150M	RoHS	15		23	0.360	560	560	
NR 3015T 220M	RoHS	22		20	0.520	470	470	
NR 3015T 330M	RoHS	33		18	0.840	390	370	
NR 3015T 470M	RoHS	47		17	1.34	320	300	

※) The saturation current value (I_{dc1}) is the DC current value having inductance decrease down to 30%. (at 20°C)

※) The temperature rise current value (I_{dc2}) is the DC current value having temperature increase up to 40°C. (at 20°C)

※) The rated current is the DC current value that satisfies both of current value saturation current value and temperature rise current value.

* This catalog contains the typical specification only due to the limitation of space. When you consider purchase of our products, please check our specification. For details of each product (characteristics graph, reliability information, precautions for use, and so on), see our Web site (<http://www.ty-top.com/>) or CD catalogs.

PART NUMBERS

● NR 4010 Shielded type

Ordering code	EHS (Environmental Hazardous Substances)	Inductance [μ H]	Inductance Tolerance	Self-resonant frequency [MHz] (min.)	DC Resistance [Ω] ($\pm 20\%$)	Rated current ※) [mA]		Measuring frequency [kHz]
						Saturation current Idc1	Temperature rise current Idc2	
NR 4010T 1R0N	RoHS	1.0	$\pm 30\%$	116	0.100	1,800	1,050	100
NR 4010T 2R2N	RoHS	2.2		73	0.150	1,150	890	
NR 4010T 3R3M	RoHS	3.3		58	0.180	1,100	820	
NR 4010T 4R7M	RoHS	4.7	$\pm 20\%$	47	0.210	900	750	
NR 4010T 6R8M	RoHS	6.8		38	0.300	740	620	
NR 4010T 100M	RoHS	10		31	0.380	560	600	
NR 4010T 150M	RoHS	15		24	0.510	470	510	
NR 4010T 220M	RoHS	22		19	0.870	360	400	
NR 4010T 330M	RoHS	33		15	1.54	280	300	
NR 4010T 470M	RoHS	47		13	1.81	240	280	

● NR 4012 Shielded type

Ordering code	EHS (Environmental Hazardous Substances)	Inductance [μ H]	Inductance Tolerance	Self-resonant frequency [MHz] (min.)	DC Resistance [Ω] ($\pm 20\%$)	Rated current ※) [mA]		Measuring frequency [kHz]
						Saturation current Idc1	Temperature rise current Idc2	
NR 4012T 1R0N	RoHS	1.0	$\pm 30\%$	131	0.060	2,500	1,500	100
NR 4012T 2R2M	RoHS	2.2		66	0.090	1,650	1,200	
NR 4012T 3R3M	RoHS	3.3		50	0.130	1,200	980	
NR 4012T 4R7M	RoHS	4.7	$\pm 20\%$	45	0.140	1,050	960	
NR 4012T 6R8M	RoHS	6.8		35	0.180	900	840	
NR 4012T 100M	RoHS	10		28	0.240	740	770	
NR 4012T 150M	RoHS	15		23	0.400	560	600	
NR 4012T 220M	RoHS	22		18	0.480	510	540	
NR 4012T 330M	RoHS	33		15	0.810	400	420	
NR 4012T 470M	RoHS	47		12	1.00	350	370	

● NR 4018 Shielded type

Ordering code	EHS (Environmental Hazardous Substances)	Inductance [μ H]	Inductance Tolerance	Self-resonant frequency [MHz] (min.)	DC Resistance [Ω] ($\pm 20\%$)	Rated current ※) [mA]		Measuring frequency [kHz]
						Saturation current Idc1	Temperature rise current Idc2	
NR 4018T 1R0N	RoHS	1.0	$\pm 30\%$	80	0.030	4,000	1,830	100
NR 4018T 2R2M	RoHS	2.2		52	0.060	2,700	1,440	
NR 4018T 3R3M	RoHS	3.3		44	0.070	2,000	1,230	
NR 4018T 4R7M	RoHS	4.7	$\pm 20\%$	34	0.090	1,700	1,200	
NR 4018T 6R8M	RoHS	6.8		29	0.110	1,450	1,060	
NR 4018T 100M	RoHS	10		24	0.180	1,200	840	
NR 4018T 150M	RoHS	15		19	0.250	940	650	
NR 4018T 220M	RoHS	22		16	0.360	800	590	
NR 4018T 330M	RoHS	33		12	0.530	650	490	
NR 4018T 470M	RoHS	47		10	0.650	570	420	
NR 4018T 680M	RoHS	68		8.3	1.00	470	320	
NR 4018T 101M	RoHS	100		6.5	1.50	400	270	
NR 4018T 151M	RoHS	150		5.5	2.50	310	220	
NR 4018T 221M	RoHS	220	4.0	4.00	270	170		

● NR 5040 Shielded type

Ordering code	EHS (Environmental Hazardous Substances)	Inductance [μ H]	Inductance Tolerance	Self-resonant frequency [MHz] (min.)	DC Resistance [Ω] ($\pm 30\%$)	Rated current ※) [mA]		Measuring frequency [kHz]
						Saturation current Idc1	Temperature rise current Idc2	
NR 5040T 1R5N	RoHS	1.5	$\pm 30\%$	60	0.020	6,000	3,600	100
NR 5040T 2R2N	RoHS	2.2		42	0.022	4,600	3,500	
NR 5040T 3R3N	RoHS	3.3		32	0.027	3,800	3,300	
NR 5040T 4R7N	RoHS	4.7	$\pm 20\%$	28	0.029	3,300	3,100	
NR 5040T 6R8M	RoHS	6.8		21	0.049	2,600	2,300	
NR 5040T 100M	RoHS	10		18	0.056	2,300	2,100	
NR 5040T 150M	RoHS	15		13	0.080	2,000	1,800	
NR 5040T 220M	RoHS	22		9	0.126	1,600	1,400	
NR 5040T 330M	RoHS	33		7	0.180	1,300	1,200	
NR 5040T 470M	RoHS	47		6	0.310	1,100	900	

● NR 6012 Shielded type

Ordering code	EHS (Environmental Hazardous Substances)	Inductance [μ H]	Inductance Tolerance	Self-resonant frequency [MHz] (min.)	DC Resistance [Ω] ($\pm 20\%$)	Rated current ※) [mA]		Measuring frequency [kHz]
						Saturation current Idc1	Temperature rise current Idc2	
NR 6012T 2R5NE	RoHS	2.5	$\pm 30\%$	45	0.090	2,100	1,730	100
NR 6012T 4R0NE	RoHS	4.0		39	0.105	1,800	1,570	
NR 6012T 5R3ME	RoHS	5.3		34	0.125	1,500	1,400	
NR 6012T 6R8ME	RoHS	6.8	$\pm 20\%$	30	0.165	1,300	1,180	
NR 6012T 100ME	RoHS	10		22	0.235	1,000	1,000	
NR 6012T 150ME	RoHS	15		18	0.330	800	790	
NR 6012T 220ME	RoHS	22		12	0.530	760	630	
NR 6012T 330ME	RoHS	33		8	0.700	590	530	
NR 6012T 470ME	RoHS	47		6	1.05	520	460	
NR 6012T 680ME	RoHS	68		3	1.35	440	410	
NR 6012T 101ME	RoHS	100	1	2.18	350	320		

※) The saturation current value (Idc1) is the DC current value having inductance decrease down to 30%. (at 20°C)

※) The temperature rise current value (Idc2) is the DC current value having temperature increase up to 40°C. (at 20°C)

※) The rated current is the DC current value that satisfies both of current value saturation current value and temperature rise current value.

* This catalog contains the typical specification only due to the limitation of space. When you consider purchase of our products, please check our specification. For details of each product (characteristics graph, reliability information, precautions for use, and so on), see our Web site (<http://www.ty-top.com/>) or CD catalogs.

PART NUMBERS

● NR 6020 Shielded type

Ordering code	EHS (Environmental Hazardous Substances)	Inductance [μ H]	Inductance Tolerance	Self-resonant frequency [MHz] (min.)	DC Resistance [Ω] ($\pm 20\%$)	Rated current ※) [mA]		Measuring frequency [kHz]
						Saturation current Idc1	Temperature rise current Idc2	
NR 6020T 0R8N	RoHS	0.8	$\pm 30\%$	110	0.020	5,500	3,800	100
NR 6020T 1R5N	RoHS	1.5		93	0.026	4,000	3,200	
NR 6020T 2R2N	RoHS	2.2		73	0.034	3,200	2,700	
NR 6020T 3R3N	RoHS	3.3		55	0.040	2,800	2,600	
NR 6020T 4R7N	RoHS	4.7		43	0.058	2,400	2,000	
NR 6020T 6R8N	RoHS	6.8	$\pm 20\%$	30	0.085	2,000	1,800	
NR 6020T 100M	RoHS	10		18	0.125	1,700	1,400	
NR 6020T 220M	RoHS	22		11	0.290	1,050	950	

● NR 6028 Shielded type

Ordering code	EHS (Environmental Hazardous Substances)	Inductance [μ H]	Inductance Tolerance	Self-resonant frequency [MHz] (min.)	DC Resistance [Ω] ($\pm 30\%$)	Rated current ※) [mA]		Measuring frequency [kHz]
						Saturation current Idc1	Temperature rise current Idc2	
NR 6028T 0R9N	RoHS	0.9	$\pm 30\%$	90	0.013	6,600	4,600	100
NR 6028T 1R5N	RoHS	1.5		78	0.016	5,000	4,200	
NR 6028T 2R2N	RoHS	2.2		68	0.020	4,200	3,700	
NR 6028T 3R0N	RoHS	3.0		55	0.023	3,600	3,400	
NR 6028T 4R7M	RoHS	4.7		39	0.031	2,700	3,000	
NR 6028T 6R0M	RoHS	6.0	$\pm 20\%$	30	0.040	2,500	2,500	
NR 6028T 100M	RoHS	10		20	0.065	1,900	1,900	
NR 6028T 150M	RoHS	15		17	0.095	1,600	1,800	
NR 6028T 220M	RoHS	22		12	0.135	1,300	1,400	
NR 6028T 330M	RoHS	33		10	0.220	1,100	1,100	
NR 6028T 470M	RoHS	47		8	0.300	950	920	
NR 6028T 680M	RoHS	68		5	0.420	760	770	
NR 6028T 101M	RoHS	100		3	0.600	620	660	

● NR 6045 Shielded type

Ordering code	EHS (Environmental Hazardous Substances)	Inductance [μ H]	Inductance Tolerance	Self-resonant frequency [MHz] (min.)	DC Resistance [Ω] ($\pm 30\%$)	Rated current ※) [mA]		Measuring frequency [kHz]
						Saturation current Idc1	Temperature rise current Idc2	
NR 6045T 1R0N	RoHS	1.0	$\pm 30\%$	110	0.014	8,500	4,200	100
NR 6045T 1R3N	RoHS	1.3		95	0.016	8,000	4,000	
NR 6045T 1R8N	RoHS	1.8		80	0.018	7,000	3,700	
NR 6045T 2R3N	RoHS	2.3		60	0.021	6,000	3,500	
NR 6045T 3R0N	RoHS	3.0		45	0.024	5,000	3,200	
NR 6045T 4R5M	RoHS	4.5	$\pm 20\%$	25	0.031	4,000	3,000	
NR 6045T 6R3M	RoHS	6.3		15	0.038	3,800	2,800	
NR 6045T 100M	RoHS	10		12	0.047	3,000	2,500	
NR 6045T 150M	RoHS	15		10	0.077	2,300	1,900	
NR 6045T 220M	RoHS	22		7	0.115	1,900	1,500	
NR 6045T 330M	RoHS	33		6	0.145	1,500	1,400	
NR 6045T 470M	RoHS	47		5	0.220	1,300	1,100	
NR 6045T 680M	RoHS	68		4	0.330	1,000	900	
NR 6045T 101M	RoHS	100		3	0.500	800	700	

● NR 8040 Shielded type

Ordering code	EHS (Environmental Hazardous Substances)	Inductance [μ H]	Inductance Tolerance	Self-resonant frequency [MHz] (min.)	DC Resistance [Ω] ($\pm 30\%$)	Rated current ※) [mA]		Measuring frequency [kHz]
						Saturation current Idc1	Temperature rise current Idc2	
NR 8040T 0R9N	RoHS	0.9	$\pm 30\%$	85	0.006	11,000	7,800	100
NR 8040T 1R4N	RoHS	1.4		63	0.007	9,000	7,000	
NR 8040T 2R0N	RoHS	2.0		50	0.009	7,400	6,300	
NR 8040T 3R6N	RoHS	3.6		34	0.015	5,300	4,900	
NR 8040T 4R7N	RoHS	4.7		30	0.018	4,700	4,100	
NR 8040T 6R8N	RoHS	6.8		24	0.025	4,000	3,700	
NR 8040T 100M	RoHS	10		$\pm 20\%$	22	0.034	3,400	
NR 8040T 150M	RoHS	15	16		0.050	2,700	2,400	
NR 8040T 220M	RoHS	22	13		0.066	2,200	2,200	
NR 8040T 330M	RoHS	33	12		0.100	1,900	1,700	
NR 8040T 470M	RoHS	47	8		0.150	1,500	1,400	
NR 8040T 680M	RoHS	68	7		0.230	1,200	1,100	
NR 8040T 101M	RoHS	100	6		0.290	1,000	1,000	

* This catalog contains the typical specification only due to the limitation of space. When you consider purchase of our products, please check our specification. For details of each product (characteristics graph, reliability information, precautions for use, and so on), see our Web site (<http://www.ty-top.com/>) or CD catalogs.

■ PART NUMBERS

● NRG 4026 Shielded type

Ordering code	Inductance [μ H]	Inductance Tolerance	Self-resonant frequency (MHz) (min.)	DC Resistance [Ω] (\pm 30%)	Rated current ※) (mA)		Measuring frequency (kHz)
					Saturation current Idc1	Temperature rise current Idc2	
NRG4026 T 1R2N	1.2	\pm 30%	120	0.030	3,100	2,300	100
NRG4026 T 2R3N	2.3		96	0.040	2,100	1,970	
NRG4026 T 3R5M	3.5		58	0.050	1,800	1,700	
NRG4026 T 4R7M	4.7	\pm 20%	46	0.055	1,450	1,600	
NRG4026 T 6R6M	6.6		33	0.065	1,300	1,500	
NRG4026 T 100M	10		26	0.085	1,000	1,300	
NRG4026 T 150M	15		19	0.110	900	1,100	
NRG4026 T 220M	22		13	0.165	610	900	
NRG4026 T 330M	33		9	0.200	540	800	
NRG4026 T 470M	47		6	0.300	410	650	

※) The saturation current (Idc1) is DC current value Inductance decrease down to 30%. (at 20°C)

※) The temperature rise current value (Idc2) is the DC current value having temperature increase up to 40°C. (at 20°C)

※) The rated current is Idc2.

* This catalog contains the typical specification only due to the limitation of space. When you consider purchase of our products, please check our specification.
For details of each product (characteristics graph, reliability information, precautions for use, and so on), see our Web site (<http://www.ty-top.com/>) or CD catalogs.

DC Bias characteristics

(Measured by HP4285A)

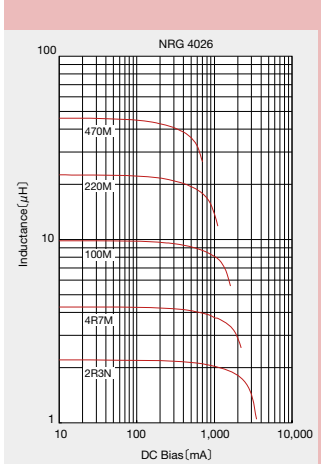
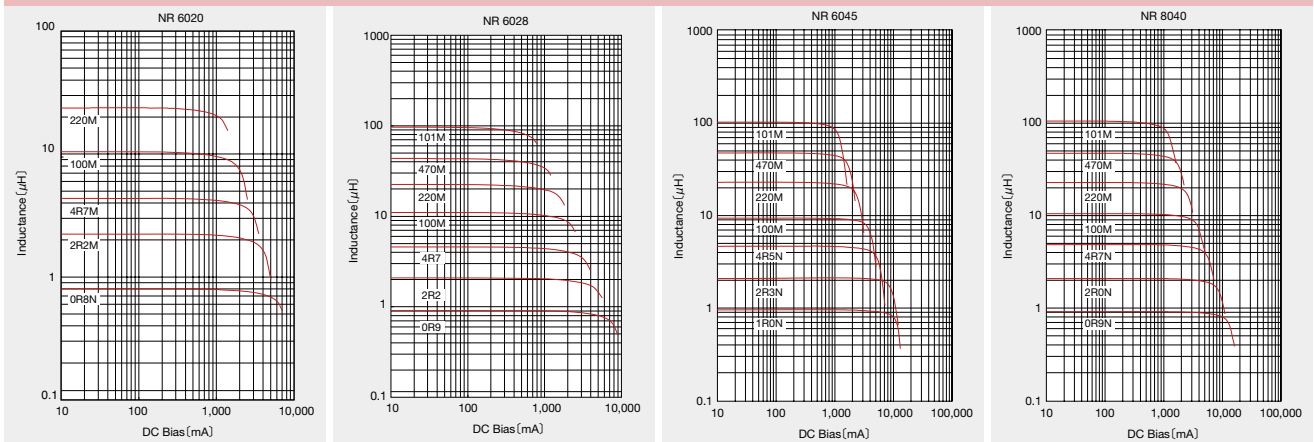
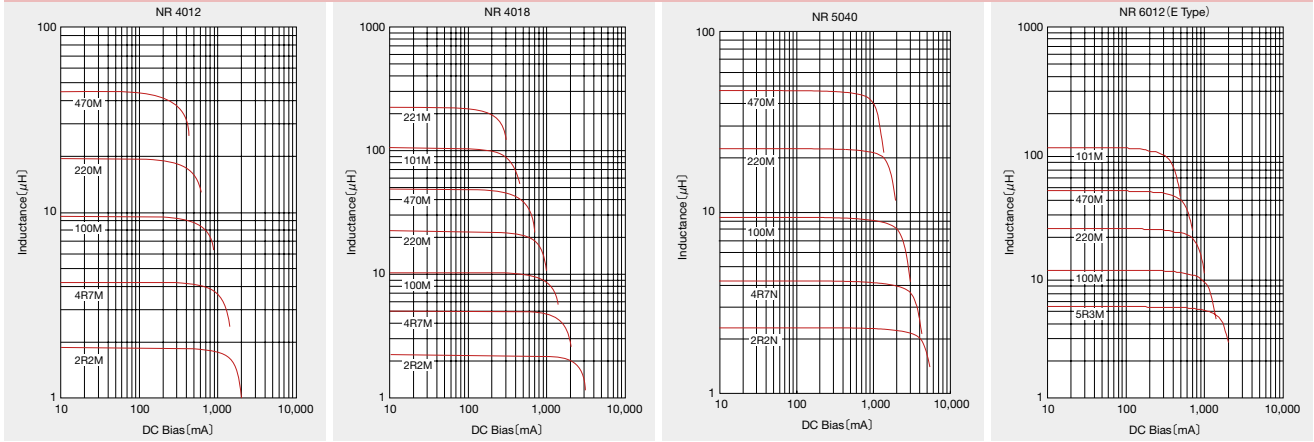
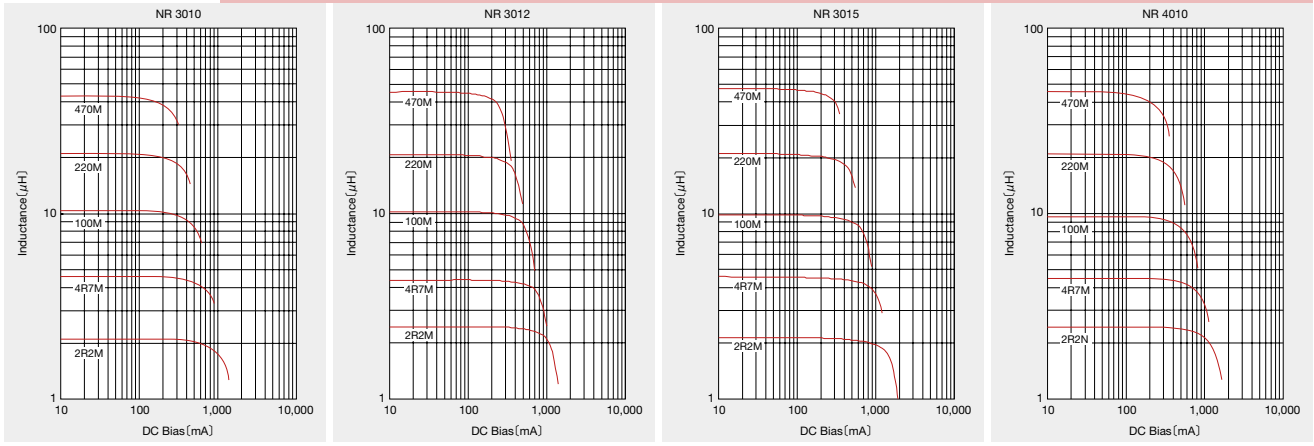

* This catalog contains the typical specification only due to the limitation of space. When you consider purchase of our products, please check our specification. For details of each product (characteristics graph, reliability information, precautions for use, and so on), see our Web site (<http://www.ty-top.com/>) or CD catalogs.

PACKAGING

① Minimum Quantity

Type	Standard Quantity [pcs]
	Tape & Reel
NRH 2410	2500
NR 3010/NRH 3010	2000
NR 3012/NRH3012/NRV3012	2000
NR 3015	2000
NR 4010	5000
NR 4012	4500
NR 4018	3500
NRG4026	2000
NRS5012	1000
NRS5014	1000
NRS5020	800
NR 5040	1500
NRS6010	1000
NR 6012	1000
NR 6020	2500
NR 6028	2000
NR 6045	1500
NR 8040	1000

② Tape Material

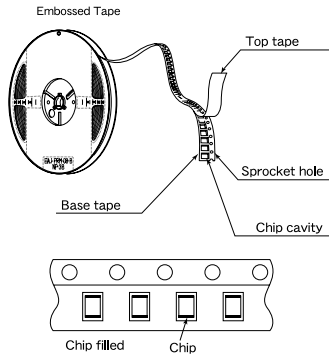

③ Taping dimensions

- Embossed tape 8mm wide (0.315 inches wide)

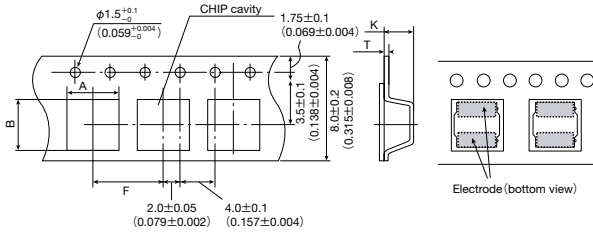

Type	Chip cavity		Insertion pitch F	Tape thickness	
	A	B		T	K
NRH 2410	2.6 \pm 0.1 (0.102 \pm 0.004)	2.6 \pm 0.1 (0.102 \pm 0.004)	4.0 \pm 0.1 (0.157 \pm 0.004)	0.25 \pm 0.05 (0.009 \pm 0.002)	1.3 \pm 0.1 (0.051 \pm 0.004)
NR 3010 NRH 3010	3.2 \pm 0.1 (0.126 \pm 0.004)	3.2 \pm 0.1 (0.126 \pm 0.004)		0.3 \pm 0.05 (0.012 \pm 0.002)	1.4 \pm 0.1 (0.055 \pm 0.004)
NR 3012 NRH 3012 NRV3012			1.6 \pm 0.1 (0.063 \pm 0.004)		
NR 3015			1.9 \pm 0.1 (0.075 \pm 0.004)		

Unit : mm (inch)

- Embossed tape 12mm wide (0.47 inches wide)

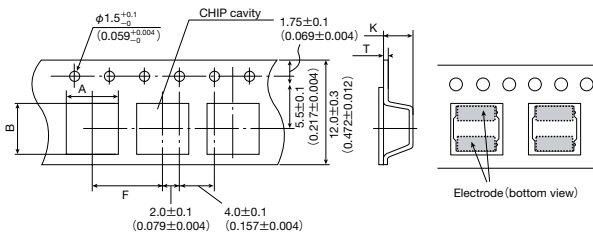

Type	Chip cavity		Insertion pitch F	Tape thickness	
	A	B		T	K
NR 4010	4.3 \pm 0.1 (0.169 \pm 0.004)	4.3 \pm 0.1 (0.169 \pm 0.004)	8.0 \pm 0.1 (0.315 \pm 0.004)	0.3 \pm 0.05 (0.012 \pm 0.002)	1.4 \pm 0.1 (0.055 \pm 0.004)
NR 4012				1.6 \pm 0.1 (0.063 \pm 0.004)	
NR 4018				2.1 \pm 0.1 (0.083 \pm 0.004)	
NRG 4026				3.1 \pm 0.1 (0.122 \pm 0.004)	
NRS 5012	5.25 \pm 0.1 (0.207 \pm 0.004)	5.25 \pm 0.1 (0.207 \pm 0.004)	8.0 \pm 0.1 (0.315 \pm 0.004)	0.3 \pm 0.05 (0.012 \pm 0.002)	1.4 \pm 0.1 (0.055 \pm 0.004)
NRS 5014					1.6 \pm 0.1 (0.063 \pm 0.004)
NRS 5020					2.3 \pm 0.1 (0.091 \pm 0.004)
NR 5040	5.15 \pm 0.1 (0.203 \pm 0.004)	5.15 \pm 0.1 (0.203 \pm 0.004)	8.0 \pm 0.1 (0.315 \pm 0.004)	0.4 \pm 0.1 (0.016 \pm 0.004)	4.2 \pm 0.1 (0.165 \pm 0.004)
NRS 6010	6.3 \pm 0.1 (0.248 \pm 0.004)	6.3 \pm 0.1 (0.248 \pm 0.004)			1.4 \pm 0.1 (0.055 \pm 0.004)
NR 6012					1.6 \pm 0.1 (0.063 \pm 0.004)
NR 6020					2.3 \pm 0.1 (0.090 \pm 0.004)
NR 6028	6.3 \pm 0.1 (0.248 \pm 0.004)	6.3 \pm 0.1 (0.248 \pm 0.004)	8.0 \pm 0.1 (0.315 \pm 0.004)	0.4 \pm 0.1 (0.016 \pm 0.004)	3.1 \pm 0.1 (0.122 \pm 0.004)
NR 6045					4.7 \pm 0.1 (0.185 \pm 0.004)

Unit : mm (inch)

- Embossed tape 16mm wide (0.63 inches wide)

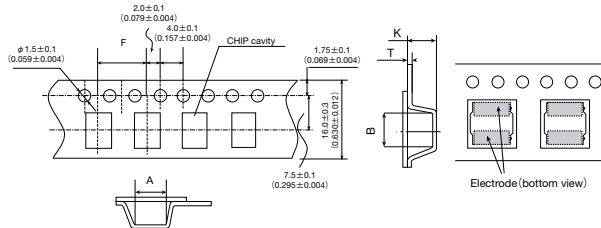

Type	Chip cavity		Insertion pitch F	Tape thickness	
	A	B		T	K
NR 8040	8.3 \pm 0.1 (0.327 \pm 0.004)	8.3 \pm 0.1 (0.327 \pm 0.004)	12.0 \pm 0.1 (0.472 \pm 0.004)	0.5 \pm 0.1 (0.020 \pm 0.004)	4.5 \pm 0.1 (0.177 \pm 0.004)

Unit : mm (inch)

④ Leader and Blank portion

- NR, NRH, NRS, NRG, NRV

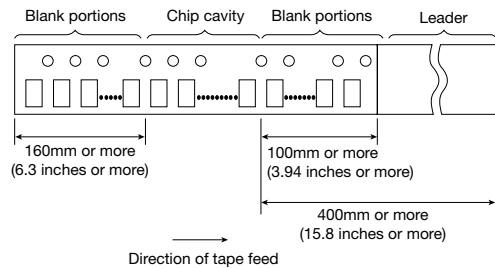

* This catalog contains the typical specification only due to the limitation of space. When you consider purchase of our products, please check our specification. For details of each product (characteristics graph, reliability information, precautions for use, and so on), see our Web site (<http://www.ty-top.com/>) or CD catalogs.

⑤ Reel size

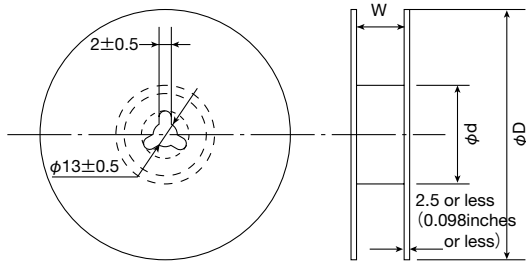

Type	Reel size (Reference values)		
	φD	φd	W
NRH2410	180±0.5 (7.087±0.019)	60±1.0 (2.36±0.04)	10.0±1.5 (0.394±0.059)
NR 3010			
NRH 3010			
NR 3012			
NRV 3012			
NR 3015	180±3.0 (7.087±0.118)	60±2.0 (2.36±0.08)	14.0±1.5 (0.551±0.059)
NRS 5012			
NRS 5014			
NRS 5020			
NRS 6010			
NR 6012			

Unit : mm (inch)

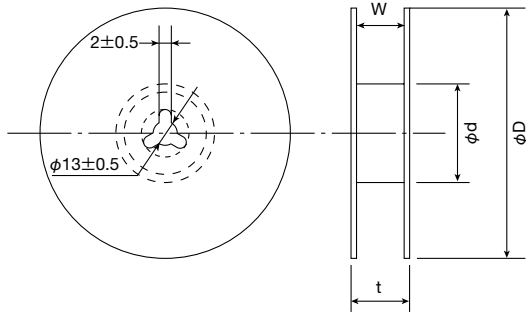

Type	Reel size (Reference values)			
	φD	φd	t (max.)	W
NR 4010	330±3.0 (12.99±0.118)	80±2.0 (3.15±0.078)	18.5 (0.72)	13.5±1.0 (0.531±0.04)
NR 4012				
NR 4018				
NRG 4026				
NR 5040				
NR 6020				
NR 6028				
NR 6045				
NR 8040	22.5 (0.89)	17.5±1.0 (0.689±0.04)		

Unit : mm (inch)

⑥ Top Tape Strength

The top tape requires a peel-off force of 0.1 to 1.3N in the direction of the arrow as illustrated below.

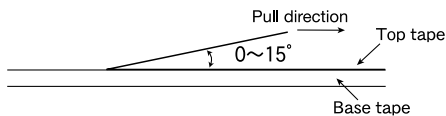

* This catalog contains the typical specification only due to the limitation of space. When you consider purchase of our products, please check our specification. For details of each product (characteristics graph, reliability information, precautions for use, and so on), see our Web site (<http://www.ty-top.com/>) or CD catalogs.

RELIABILITY DATA

1. Operating Temperature Range	
BRC1608, BRL2012, BRC2016, BRC2518, BRFL2518, BRL2518, BRL3225 Type	-25~+105°C
NR30/40/50/60/80, NRV30, NRG40, NRH24/30, NRS50/60 Type	-25~+120°C
NR10050 Type	-25~+105°C
【Test Method and Remarks】 Including self-generated heat	
2. Storage Temperature Range	
BRC1608, BRL2012, BRC2016, BRC2518, BRFL2518, BRL2518, BRL3225 Type	-40~+85°C
NR30/40/50/60/80, NRV30, NRG40, NRH24/30, NRS50/60 Type	
NR10050 Type	
【Test Method and Remarks】 BRC1608, BRL2012, BRC2016, BRC2518, BRFL2518, BRL2518, BRL3225 Type, NR30/40/50/60/80, NRV30, NRG40, NRH24/30, NRS50/60 Type : 0 to 40°C for the product with taping. NR10050 Type : 0~40°C for the product with taping.	
3. Rated current	
BRC1608, BRL2012, BRC2016, BRC2518, BRFL2518, BRL2518, BRL3225 Type	Within the specified tolerance
NR30/40/50/60/80, NRV30, NRG40, NRH24/30, NRS50/60 Type	
NR10050 Type	
4. Inductance	
BRC1608, BRL2012, BRC2016, BRC2518, BRFL2518, BRL2518, BRL3225 Type	Within the specified tolerance
NR30/40/50/60/80, NRV30, NRG40, NRH24/30, NRS50/60 Type	
NR10050 Type	
【Test Method and Remarks】 BRC1608, BRL2012, BRC2016, BRC2518, BRFL2518, BRL2518, BRL3225 Type : LCR Meter : HP 4285A or equivalent, Measuring frequency : Specified frequency NR30/40/50/60/80, NRV30, NRG40, NRH24/30, NRS50/60 Type : LCR Meter : HP 4285A or equivalent, 100KHz, 1V NR10050 Type : LCR Meter : HP 4263A or equivalent, 100KHz, 1V	
5. DC Resistance	
BRC1608, BRL2012, BRC2016, BRC2518, BRFL2518, BRL2518, BRL3225 Type	Within the specified tolerance
NR30/40/50/60/80, NRV30, NRG40, NRH24/30, NRS50/60 Type	
NR10050 Type	
【Test Method and Remarks】 DC ohmmeter : HIOKI 3227 or equivalent	
6. Self resonance frequency	
BRC1608, BRL2012, BRC2016, BRC2518, BRFL2518, BRL2518, BRL3225 Type	Within the specification
NR30/40/50/60/80, NRV30, NRG40, NRH24/30, NRS50/60 Type	
NR10050 Type	
【Test Method and Remarks】 BRC1608, BRL2012, BRC2016, BRC2518, BRFL2518, BRL2518, BRL3225 Type, NR30/40/50/60/80, NRV30, NRG40, NRH24/30, NRS50/60 Type, NR10050 Type : Impedance analyzer/material analyzer : HP4291A or equivalent HP4191A, 4192A or equivalent	
7. Temperature characteristic	
BRC1608, BRL2012, BRC2016, BRC2518, BRFL2518, BRL2518, BRL3225 Type	BRL2012, BRC2016, BRL2518, BRL3225, BRC2518, BRFL2518 Inductance change : Within ±15%
NR30/40/50/60/80, NRV30, NRG40, NRH24/30, NRS50/60 Type	BRC1608 Inductance change : Within ±20%
NR10050 Type	Inductance change : Within ±20%
【Test Method and Remarks】 BRC1608, BRL2012, BRC2016, BRC2518, BRFL2518, BRL2518, BRL3225 Type, NR30/40/50/60/80, NRV30, NRG40, NRH24/30, NRS50/60 Type, NR10050 Type : Measurement of inductance shall be taken at temperature range within -25°C~+85°C. With reference to inductance value at +20°C., change rate shall be calculated.	
Change of maximum inductance deviation in step 1 to 5	
Temperature at step 1	20°C
Temperature at step 2	Minimum operating temperature
Temperature at step 3	20°C (Standard temperature)
Temperature at step 4	Maximum operating temperature
Temperature at step 5	20°C

* This catalog contains the typical specification only due to the limitation of space. When you consider purchase of our products, please check our specification.
For details of each product (characteristics graph, reliability information, precautions for use, and so on), see our Web site (<http://www.ty-top.com/>) or CD catalogs.

RELIABILITY DATA

8. Resistance to flexure of substrate

BRC1608, BRL2012, BRC2016, BRC2518, BRFL2518, BRL2518, BRL3225 Type	No damage.
NR30/40/50/60/80, NRV30, NRG40, NRH24/30, NRS50/60 Type	
NR10050 Type	

[Test Method and Remarks]

BRC1608, BRL2012, BRC2016, BRC2518, BRFL2518, BRL2518, BRL3225 Type, NR30/40/50/60/80, NRV30, NRG40, NRH24/30, NRS50/60 Type :

The test samples shall be soldered to the test board by the reflow. As illustrated below, apply force in the direction of the arrow indicating until deflection of the test board reaches to 2 mm.

Test board size : 100×40×1.0
 Test board material : glass epoxy-resin
 Solder cream thickness : 0.12 (BR Series)
 0.10 (NR30/40, NRV30, NRH24/30, NRG40)
 0.15 (NR50/60/80, NRS50/60)

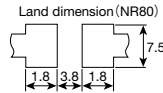
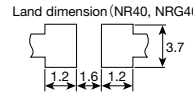
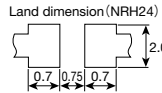
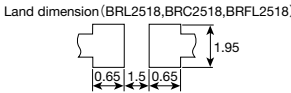
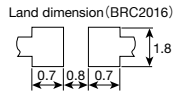
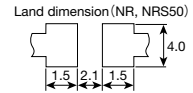
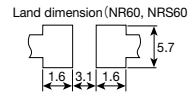
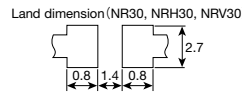
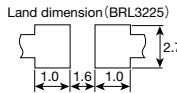
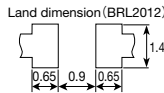
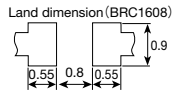
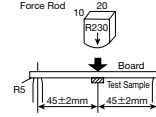

Printed board thickness : 1.0mm
 Unit : mm

9. Insulation resistance : between wires

BRC1608, BRL2012, BRC2016, BRC2518, BRFL2518, BRL2518, BRL3225 Type	
NR30/40/50/60/80, NRV30, NRG40, NRH24/30, NRS50/60 Type	
NR10050 Type	

10. Insulation resistance : between wire and core

BRC1608, BRL2012, BRC2016, BRC2518, BRFL2518, BRL2518, BRL3225 Type	
NR30/40/50/60/80, NRV30, NRG40, NRH24/30, NRS50/60 Type	
NR10050 Type	

11. Withstanding voltage : between wires and core

BRC1608, BRL2012, BRC2016, BRC2518, BRFL2518, BRL2518, BRL3225 Type	
NR30/40/50/60/80, NRV30, NRG40, NRH24/30, NRS50/60 Type	
NR10050 Type	

12. Adhesion of terminal electrode

BRC1608, BRL2012, BRC2016, BRC2518, BRFL2518, BRL2518, BRL3225 Type	Shall not come off PC board.
NR30/40/50/60/80, NRV30, NRG40, NRH24/30, NRS50/60 Type	
NR10050 Type	

[Test Method and Remarks]

BRC2012, BRC2016, BRC2518, BRFL2518, BRL2518, BRL3225 Type, NR30/40/50/60/80, NRV30, NRG40, NRH24/30, NRS50/60 Type :

The test samples shall be soldered to the test board by the reflow.

- Applied force : 10N to X and Y directions.
- Duration : 5s.
- Solder cream thickness : 0.15mm.

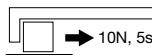

BRC1608, NR10050 Type :

- Applied force : 5N to X and Y directions.
- Duration : 5s.

13. Resistance to vibration

BRC1608, BRL2012, BRC2016, BRC2518, BRFL2518, BRL2518, BRL3225 Type	Inductance change : Within ±10% No significant abnormality in appearance.
NR30/40/50/60/80, NRV30, NRG40, NRH24/30, NRS50/60 Type	
NR10050 Type	

[Test Method and Remarks]

BRC1608, BRL2012, BRC2016, BRC2518, BRFL2518, BRL2518, BRL3225 Type, NR30/40/50/60/80, NRV30, NRG40, NRH24/30, NRS50/60 Type, NR10050 Type :

The test samples shall be soldered to the test board by the reflow.

Then it shall be submitted to below test conditions.

Frequency Range	10~55Hz	
Total Amplitude	1.5mm (May not exceed acceleration 196m/s ²)	
Sweeping Method	10Hz to 55Hz to 10Hz for 1min.	
Time	X	For 2 hours on each X, Y, and Z axis.
	Y	
	Z	

Recovery : At least 2hrs of recovery under the standard condition after the test, followed by the measurement within 48hrs.

* This catalog contains the typical specification only due to the limitation of space. When you consider purchase of our products, please check our specification. For details of each product (characteristics graph, reliability information, precautions for use, and so on), see our Web site (<http://www.ty-top.com/>) or CD catalogs.

RELIABILITY DATA

14. Solderability

BRC1608, BRL2012, BRC2016, BRC2518, BRFL2518, BRL2518, BRL3225 Type	At least 90% of surface of terminal electrode is covered by new solder.
NR30/40/50/60/80, NRV30, NRG40, NRH24/30, NRS50/60 Type	
NR10050 Type	

[Test Method and Remarks]

BRC1608, BRL2012, BRC2016, BRC2518, BRFL2518, BRL2518, BRL3225 Type, NR30/40/50/60/80, NRV30, NRG40, NRH24/30, NRS50/60 Type, NR10050 Type :
The test samples shall be dipped in flux, and then immersed in molten solder as shown in below table.
Flux : Methanol solution containing rosin 25%.

NR30/40/50/60/80, NRV30, NRG40, NRH24/30, NRS50/60 Type :

Solder Temperature	245±5°C
Time	5±1.0 sec.

BRC1608, BRL2012, BRC2016, BRC2518, BRFL2518, BRL2518, BRL3225 Type :

Solder Temperature	245±5°C
Time	5±0.5 sec.

※Immersion depth : All sides of mounting terminal shall be immersed.

15. Resistance to soldering heat

BRC1608, BRL2012, BRC2016, BRC2518, BRFL2518, BRL2518, BRL3225 Type	Inductance change : Within ±10% No significant abnormality in appearance.
NR30/40/50/60/80, NRV30, NRG40, NRH24/30, NRS50/60 Type	
NR10050 Type	

[Test Method and Remarks]

BRC1608, BRL2012, BRC2016, BRC2518, BRFL2518, BRL2518, BRL3225 Type :
3 times of reflow oven at 230°C MIN. for 40sec. with peak temperature at 260⁺⁰₋₅°C for 5sec.

NR30/40/50/60/80, NRV30, NRG40, NRH24/30, NRS50/60 Type, NR10050 Type :
The test sample shall be exposed to reflow oven at 230±5°C for 40 seconds, with peak temperature at 260±5°C for 5 seconds, 2 times.

NR6020 Type :

The test sample shall be exposed to reflow oven at 230±5°C for 40 seconds, with peak temperature at 250⁺⁰₋₅°C for 5 seconds, 2 times.

Test board thickness : 1.0mm

Test board material : glass epoxy-resin

16. Thermal shock

BRC1608, BRL2012, BRC2016, BRC2518, BRFL2518, BRL2518, BRL3225 Type	Inductance change : Within ±10% No significant abnormality in appearance.
NR30/40/50/60/80, NRV30, NRG40, NRH24/30, NRS50/60 Type	
NR10050 Type	

[Test Method and Remarks]

BRC1608, BRL2012, BRC2016, BRC2518, BRFL2518, BRL2518, BRL3225 Type, NR30/40/50/60/80, NRV30, NRG40, NRH24/30, NRS50/60 Type, NR10050 Type :
The test samples shall be soldered to the test board by the reflow. The test samples shall be placed at specified temperature for specified time by step 1 to step 4 as shown in below table in sequence. The temperature cycle shall be repeated 100 cycles.

Conditions of 1 cycle		
Step	Temperature (°C)	Duration (min)
1	-40±3	30±3
2	Room temperature	Within 3
3	+85±2	30±3
4	Room temperature	Within 3

17. Damp heat

BRC1608, BRL2012, BRC2016, BRC2518, BRFL2518, BRL2518, BRL3225 Type	Inductance change : Within ±10% No significant abnormality in appearance.
NR30/40/50/60/80, NRV30, NRG40, NRH24/30, NRS50/60 Type	
NR10050 Type	

[Test Method and Remarks]

BRC1608, BRL2012, BRC2016, BRC2518, BRFL2518, BRL2518, BRL3225 Type :

Temperature	60±2°C
Humidity	90~95%RH
Time	1000 hours.

Recovery : At least 2hrs of recovery under the standard condition after the test, followed by the measurement within 48 hrs.

NR30/40/50/60/80, NRV30, NRG40, NRH24/30, NRS50/60 Type :

The test samples shall be soldered to the test board by the reflow.

The test samples shall be placed in thermostatic oven set at specified temperature and humidity as shown in below table.

Temperature	60±2°C
Humidity	90~95%RH
Time	500±24hour

* This catalog contains the typical specification only due to the limitation of space. When you consider purchase of our products, please check our specification.
For details of each product (characteristics graph, reliability information, precautions for use, and so on), see our Web site (<http://www.ty-top.com/>) or CD catalogs.

RELIABILITY DATA

18. Loading under damp heat

BRC1608, BRL2012, BRC2016, BRC2518, BRFL2518, BRL2518, BRL3225 Type	Inductance change : Within $\pm 10\%$ No significant abnormality in appearance.
NR30/40/50/60/80, NRV30, NRG40, NRH24/30, NRS50/60 Type	
NR10050 Type	

[Test Method and Remarks]

BRC1608, BRL2012, BRC2016, BRC2518, BRFL2518, BRL2518, BRL3225 Type :

Temperature	60 \pm 2 $^{\circ}$ C
Humidity	90~95%RH
Applied current	Rated current
Time	1000hours.

Recovery : At least 2hrs of recovery under the standard condition after the test, followed by the measurement within 48 hrs.

NR30/40/50/60/80, NRV30, NRG40, NRH24/30, NRS50/60 Type, NR10050 Type :

The test samples shall be soldered to the test board by the reflow.

The test samples shall be placed in thermostatic oven set at specified temperature and humidity and applied the rated current continuously as shown in below table.

Temperature	60 \pm 2 $^{\circ}$ C
Humidity	90~95%RH
Applied current	Rated current
Time	500 \pm 2hour

19. Low temperature life test

BRC1608, BRL2012, BRC2016, BRC2518, BRFL2518, BRL2518, BRL3225 Type	Inductance change : Within $\pm 10\%$ No significant abnormality in appearance.
NR30/40/50/60/80, NRV30, NRG40, NRH24/30, NRS50/60 Type	
NR10050 Type	

[Test Method and Remarks]

BRC1608, BRL2012, BRC2016, BRC2518, BRFL2518, BRL2518, BRL3225 Type :

Temperature	-40 \pm 2 $^{\circ}$ C
Duration	1000hours

Recovery : At least 2hrs of recovery under the standard condition after the test, followed by the measurement within 48 hrs.

NR30/40/50/60/80, NRV30, NRG40, NRH24/30, NRS50/60 Type, NR10050 Type :

The test samples shall be soldered to the test board by the reflow.

After that, the test samples shall be placed at test conditions as shown in below table.

Temperature	-40 \pm 3 $^{\circ}$ C
Time	500 \pm 24hour

20. High temperature life test

BRC1608, BRL2012, BRC2016, BRC2518, BRFL2518, BRL2518, BRL3225 Type	Inductance change : Within $\pm 10\%$ No significant abnormality in appearance.
NR30/40/50/60/80, NRV30, NRG40, NRH24/30, NRS50/60 Type	
NR10050 Type	Inductance change : Within $\pm 10\%$ No significant abnormality in appearance.

[Test Method and Remarks]

BRC1608, BRL2012, BRC2016, BRC2518, BRFL2518, BRL2518, BRL3225 Type :

Temperature	85 \pm 2 $^{\circ}$ C
Duration	1000hours

Recovery : At least 2hrs of recovery under the standard condition after the test, followed by the measurement within 48 hrs.

NR10050 Type :

Temperature	105 \pm 3 $^{\circ}$ C
Time	500 \pm 24hour

Recovery : At least 2hrs of recovery under the standard condition after the test, followed by the measurement within 48 hrs.

21. Loading at high temperature life test

BRC1608, BRL2012, BRC2016, BRC2518, BRFL2518, BRL2518, BRL3225 Type	Inductance change : Within $\pm 10\%$ No significant abnormality in appearance.
NR30/40/50/60/80, NRV30, NRG40, NRH24/30, NRS50/60 Type	
NR10050 Type	

[Test Method and Remarks]

NR30/40/50/60/80, NRV30, NRG40, NRH24/30, NRS50/60 Type :

The test samples shall be soldered to the test board by the reflow soldering.

Temperature	85 \pm 2 $^{\circ}$ C
Applied current	Rated current
Time	500 \pm 24hour

22. Standard condition

BRC1608, BRL2012, BRC2016, BRC2518, BRFL2518, BRL2518, BRL3225 Type	Standard test condition : Unless otherwise specified, temperature is 20 \pm 15% and 65 \pm 20% of relative humidity. When there are question concerning measurement result : In order to provide correlation date, the test shall be condition of 20 \pm 2 $^{\circ}$ C of temperature, 65 \pm 5% relative humidity. Inductance is in accordance with our measured value.
NR30/40/50/60/80, NRV30, NRG40, NRH24/30, NRS50/60 Type	
NR10050 Type	

* This catalog contains the typical specification only due to the limitation of space. When you consider purchase of our products, please check our specification.
For details of each product (characteristics graph, reliability information, precautions for use, and so on), see our Web site (<http://www.ty-top.com/>) or CD catalogs.

PRECAUTIONS

SMD Inductors

1. Circuit Design

Precautions	<ul style="list-style-type: none"> ◆ Operating environment <ol style="list-style-type: none"> 1. The products described in this specification are intended for use in general electronic equipment, (office supply equipment, telecommunications systems, measuring equipment, and household equipment). They are not intended for use in mission-critical equipment or systems requiring special quality and high reliability (traffic systems, safety equipment, aerospace systems, nuclear control systems and medical equipment including life-support systems,) where product failure might result in loss of life, injury or damage. For such uses, contact TAIYO YUDEN Sales Department in advance.
-------------	---

2. PCB Design

Precautions	<ul style="list-style-type: none"> ◆ Land pattern design <ol style="list-style-type: none"> 1. Please refer to a recommended land pattern.
Technical considerations	<ul style="list-style-type: none"> ◆ Land pattern design <ul style="list-style-type: none"> Surface Mounting <ul style="list-style-type: none"> • Mounting and soldering conditions should be checked beforehand. • Applicable soldering process to this products is reflow soldering only.

3. Considerations for automatic placement

Precautions	<ul style="list-style-type: none"> ◆ Adjustment of mounting machine <ol style="list-style-type: none"> 1. Excessive impact load should not be imposed on the products when mounting onto the PC boards. 2. Mounting and soldering conditions should be checked beforehand.
Technical considerations	<ul style="list-style-type: none"> ◆ Adjustment of mounting machine <ol style="list-style-type: none"> 1. When installing products, care should be taken not to apply distortion stress as it may deform the products.

4. Soldering

Precautions	<ul style="list-style-type: none"> ◆ Reflow soldering <ol style="list-style-type: none"> 1. Please contact any of our offices for a reflow soldering, and refer to the recommended condition specified. 2. This products is reflow soldering only. 3. Please do not add any stress to a product until it returns in normal temperature after reflow soldering. ◆ Lead free soldering <ol style="list-style-type: none"> 1. When using products with lead free soldering, we request to use them after confirming of adhesion, temperature of resistance to soldering heat, soldering etc sufficiently. ◆ Recommended conditions for using a soldering iron (NR10050 Type) <ul style="list-style-type: none"> • Put the soldering iron on the land-pattern. • Soldering iron's temperature - Below 350°C • Duration - 3 seconds or less • The soldering iron should not directly touch the inductor.
Technical considerations	<ul style="list-style-type: none"> ◆ Reflow soldering <ol style="list-style-type: none"> 1. If products are used beyond the range of the recommended conditions, heat stresses may deform the products, and consequently degrade the reliability of the products. <div style="display: flex; justify-content: space-around;"> <div style="text-align: center;"> <p>• BRC1608, BRL2012, BRL2518, BRC2016, BRL3225 Type BRC2518, BRFL2518 Recommended reflow condition (Pb free solder)</p> </div> <div style="text-align: center;"> <p>• NR30/40/50/60/80, NRV30, NRG40, NRH24/30, NRS50/60 Type Recommended reflow condition (Pb free solder)</p> </div> <div style="text-align: center;"> <p>• NR10050 Type Recommended reflow condition (Pb free solder)</p> </div> </div>

5. Cleaning

Precautions	<ul style="list-style-type: none"> ◆ Cleaning conditions <ol style="list-style-type: none"> 1. Washing by supersonic waves shall be avoided.
Technical considerations	<ul style="list-style-type: none"> ◆ Cleaning conditions <ol style="list-style-type: none"> 1. If washing by supersonic waves, supersonic waves may cause broken products.

6. Handling

Precautions	<ul style="list-style-type: none"> ◆ Handling <ol style="list-style-type: none"> 1. Keep the product away from all magnets and magnetic objects. ◆ Breakaway PC boards (splitting along perforations) <ol style="list-style-type: none"> 1. When splitting the PC board after mounting product, care should be taken not to give any stresses of deflection or twisting to the board. 2. Board separation should not be done manually, but by using the appropriate devices. ◆ Mechanical considerations <ol style="list-style-type: none"> 1. Please do not give the product any excessive mechanical shocks. 2. Please do not add any shock and power to a product in transportation. ◆ Pick-up pressure <ol style="list-style-type: none"> 1. Please do not push to add any pressure to a winding part. Please do not give any shock and push into a ferrite core exposure part.. ◆ Packing <ol style="list-style-type: none"> 1. Please avoid accumulation of a packing box as much as possible.
Technical considerations	<ul style="list-style-type: none"> ◆ Breakaway PC boards (splitting along perforations) <ol style="list-style-type: none"> 1. Planning pattern configurations and the position of products should be carefully performed to minimize stress. ◆ Mechanical considerations <ol style="list-style-type: none"> 1. There is a case to be damaged by a mechanical shock. 2. There is a case to be broken by the handling in transportation. ◆ Pick-up pressure <ol style="list-style-type: none"> 1. Damage and a characteristic can vary with an excessive shock or stress. ◆ Packing <ol style="list-style-type: none"> 1. There is a case that transformation and a product of tape are damaged by accumulation of a packing box.

7. Storage conditions

Precautions	<ul style="list-style-type: none"> ◆ Storage <ol style="list-style-type: none"> 1. To maintain the solderability of terminal electrodes and to keep the packing material in good condition, temperature and humidity in the storage area should be controlled. <ul style="list-style-type: none"> • Recommended conditions <ul style="list-style-type: none"> Ambient temperature: 0~40°C Humidity : Below 70% RH <p>The ambient temperature must be kept below 30°C. Even under ideal storage conditions, solderability of products electrodes may decrease as time passes. For this reason, product should be used within 6 months from the time of delivery. In case of storage over 6 months, solderability shall be checked before actual usage.</p>
Technical considerations	<ul style="list-style-type: none"> ◆ Storage <ol style="list-style-type: none"> 1. Under a high temperature and humidity environment, problems such as reduced solderability caused by oxidation of terminal electrodes and deterioration of taping/packaging materials may take place.

* This catalog contains the typical specification only due to the limitation of space. When you consider purchase of our products, please check our specification. For details of each product (characteristics graph, reliability information, precautions for use, and so on), see our Web site (<http://www.ty-top.com/>) or CD catalogs.

Mouser Electronics

Authorized Distributor

Click to View Pricing, Inventory, Delivery & Lifecycle Information:

[Taiyo Yuden:](#)

[NRG4026T100M](#) [NRG4026T150M](#) [NRG4026T1R2N](#) [NRG4026T220M](#) [NRG4026T2R3N](#) [NRG4026T330M](#)
[NRG4026T3R5M](#) [NRG4026T470M](#) [NRG4026T4R7M](#) [NRG4026T6R6M](#)