

1000W, 10V - 100V Surface Mount Transient Voltage Suppressor

FEATURES

- Ideal for automated placement
- Glass passivated junction
- Excellent clamping capability
- Fast response time: Typically less than 1.0ps from 0 V to BV min
- Moisture sensitivity level: level 1, per J-STD-020
- AEC-Q101 qualified available: ordering code with suffix "H"
- Compliant to RoHS Directive 2011/65/EU and in accordance to WEEE 2002/96/EC

KEY PARAMETERS		
PARAMETER	VALUE	UNIT
V_{WM}	8.55 – 85.5	V
V_{BR} (uni-directional)	9.5 - 105	V
V_{BR} (bi-directional)	9.5 - 105	V
P_{PPSM}	1000	W
$T_{J\ MAX}$	175	°C
Package	DO-214AA (SMB)	
Configuration	Single die	

APPLICATIONS

- Switching mode power supply (SMPS)
- Adapters
- TV
- Monitor

DO-214AA (SMB)

MECHANICAL DATA

- Case: DO-214AA (SMB)
- Molding compound meets UL 94V-0 flammability rating
- Terminal: Matte tin plated leads, solderable per J-STD-002
- Meet JESD 201 class 2 whisker test
- Polarity: As marked
- Weight: 0.11 g (approximately)

ABSOLUTE MAXIMUM RATINGS ($T_A = 25^\circ\text{C}$ unless otherwise noted)

PARAMETER	SYMBOL	VALUE	UNIT
Non-repetitive peak impulse power dissipation with 10/1000 μs waveform ⁽¹⁾	P_{PK}	1000	W
Steady state power dissipation at $T_A=25^\circ\text{C}$	P_D	5	W
Peak forward surge current, 8.3 ms single half sine-wave superimposed on rated load for Uni-directional only	I_{FSM}	100	A
Forward Voltage @ $I_F=50\text{A}$ for Uni-directional only ⁽²⁾	V_F	3.5 / 5.0	V
Junction temperature	T_J	-55 to +175	°C
Storage temperature	T_{STG}	-55 to +175	°C

Notes:

1. Non-repetitive Current Pulse Per Fig. 3 and Derated above $T_A=25^\circ\text{C}$ Per Fig. 2
2. $V_F=3.5\text{V}$ for Devices of $V_{BR}\leq 50\text{V}$ and $V_F=5.0\text{V}$ Max. for Devices $V_{BR}>50\text{V}$

Devices for Bipolar Applications

1. For Bidirectional use CA suffix

THERMAL PERFORMANCE			
PARAMETER	SYMBOL	TYP	UNIT
Junction-to-lead thermal resistance	$R_{\theta JL}$	20	°C/W
Junction-to-ambient thermal resistance	$R_{\theta JA}$	100	°C/W

ELECTRICAL SPECIFICATIONS ($T_A = 25^\circ\text{C}$ unless otherwise noted)

Device	Device Marking Code	Breakdown Voltage $V_{BR@I_T}$ (V) (Note 1)		Test Current I_T (mA)	Stand-Off Voltage V_{WM} (V)	Maximum Reverse Leakage @ V_{WM} (μA)	Maximum Peak impulse Current I_{PP} (A)	Maximum Clamping Voltage $V_C@I_{PP}$ (V)
		Min.	Max.					
1KSMB10A	A10E	9.5	10.5	1.0	8.55	10.0	69.0	14.5
1KSMB10CA	N10E							
1KSMB11A	A10F	10.5	11.6	1.0	9.40	5.0	64.1	15.6
1KSMB11CA	N10F							
1KSMB12A	A10G	11.4	12.6	1.0	10.2	5.0	59.9	16.7
1KSMB12CA	N10G							
1KSMB13A	A10H	12.4	13.7	1.0	11.1	5.0	54.9	18.2
1KSMB13CA	N10H							
1KSMB15A	A10I	14.3	15.8	1.0	12.8	5.0	47.2	21.2
1KSMB15CA	N10I							
1KSMB16A	A10J	15.2	16.8	1.0	13.6	1.0	44.4	22.5
1KSMB16CA	N10J							
1KSMB18A	A10K	17.1	18.9	1.0	15.3	1.0	39.2	25.5
1KSMB18CA	N10K							
1KSMB20A	A10L	19.0	21.0	1.0	17.1	1.0	36.1	27.7
1KSMB20CA	N10L							
1KSMB22A	A10M	20.9	23.1	1.0	18.8	1.0	32.7	30.6
1KSMB22CA	N10M							
1KSMB24A	A10N	22.8	25.2	1.0	20.5	1.0	30.1	33.2
1KSMB24CA	N10N							
1KSMB27A	A10O	25.7	28.4	1.0	23.1	1.0	26.7	37.5
1KSMB27CA	N10O							
1KSMB30A	A10P	28.5	31.5	1.0	25.6	1.0	24.2	41.4
1KSMB30CA	N10P							
1KSMB33A	A10Q	31.4	34.7	1.0	28.2	1.0	21.9	45.7
1KSMB33CA	N10Q							
1KSMB36A	A10R	34.2	37.8	1.0	30.8	1.0	20.0	49.9
1KSMB36CA	N10R							
1KSMB39A	A10S	37.1	41.0	1.0	33.3	1.0	18.6	53.9
1KSMB39CA	N10S							
1KSMB43A	A10T	40.9	45.2	1.0	36.8	1.0	16.9	59.3
1KSMB43CA	N10T							
1KSMB47A	A10U	44.7	49.4	1.0	40.2	1.0	15.4	64.8
1KSMB47CA	N10U							
1KSMB51A	A10V	48.5	53.6	1.0	43.6	1.0	14.3	70.1
1KSMB51CA	N10V							
1KSMB56A	A10W	53.2	58.8	1.0	47.8	1.0	13.0	77.0
1KSMB56CA	N10W							
1KSMB62A	A10X	58.9	65.1	1.0	53.0	1.0	11.8	85.0
1KSMB62CA	N10X							
1KSMB68A	A10Y	64.6	71.4	1.0	58.1	1.0	10.9	92.0
1KSMB68CA	N10Y							

ELECTRICAL SPECIFICATIONS ($T_A = 25^\circ\text{C}$ unless otherwise noted)

Device	Device Marking Code	Breakdown voltage $V_{BR@I_T}$ (V) (Note 1)		Test current I_T (mA)	Stand-Off Voltage V_{WM} (V)	Maximum Reverse leakage @ V_{WM} (μA)	Maximum peak impulse current I_{PP} (A)	Maximum clamping voltage $V_C@I_{PP}$ (V)
		Min.	Max.					
1KSMB75A	A10Z	71.3	78.8	1.0	64.1	1.0	9.7	103
1KSMB75CA	N10Z							
1KSMB82A	B10A	77.9	86.1	1.0	70.1	1.0	8.8	113
1KSMB82CA	O10A							
1KSMB91A	B10B	86.5	95.5	1.0	77.8	1.0	8.0	125
1KSMB91CA	O10B							
1KSMB100A	B10C	95	105	1.0	85.5	1.0	7.3	137
1KSMB100CA	O10C							

Notes:

1. V_{BR} measure after I_T applied for 30ms, I_T =square wave pulse or equivalent.
2. All terms and symbols are consistent with ANSI/IEEE C62.35.
3. For Bidirectional use CA suffix

ORDERING INFORMATION

ORDERING CODE (Note 1,2,3)	PACKAGE	PACKING	STATUS
1KSMBxxxxHR5G	SMB	850 / 7" Plastic reel	Active
1KSMBxxxxHR4G	SMB	3,000 / 13" Paper reel	NRND
1KSMBxxxxHM4G	SMB	3,000 / 13" Plastic reel	Active
1KSMBxxxx R5G	SMB	850 / 7" Plastic reel	Active
1KSMBxxxx R4G	SMB	3,000 / 13" Paper reel	NRND
1KSMBxxxx M4G	SMB	3,000 / 13" Plastic reel	Active
1KSMBxxxxHR5	SMB	850 / 7" Plastic reel	Active
1KSMBxxxxHR4	SMB	3,000 / 13" Paper reel	NRND
1KSMBxxxxHM4	SMB	3,000 / 13" Plastic reel	Active
1KSMBxxxx R5	SMB	850 / 7" Plastic reel	Active
1KSMBxxxx R4	SMB	3,000 / 13" Paper reel	NRND
1KSMBxxxx M4	SMB	3,000 / 13" Plastic reel	Active

Note 1:

"xxxx" defines voltage from 10V (1KSMB10A) to 100V (1KSMB100CA)

Note 2:

"H" means AEC-Q101 qualified

Note 3:

"G" means green compound (halogen free)

CHARACTERISTICS CURVES

($T_A = 25^\circ\text{C}$ unless otherwise noted)

Fig1. Peak Pulse Power Rating Curve

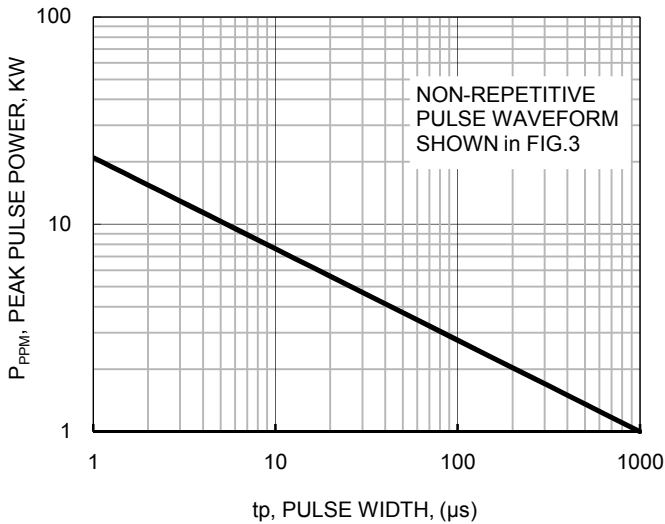

Fig2. Pulse Derating Curve

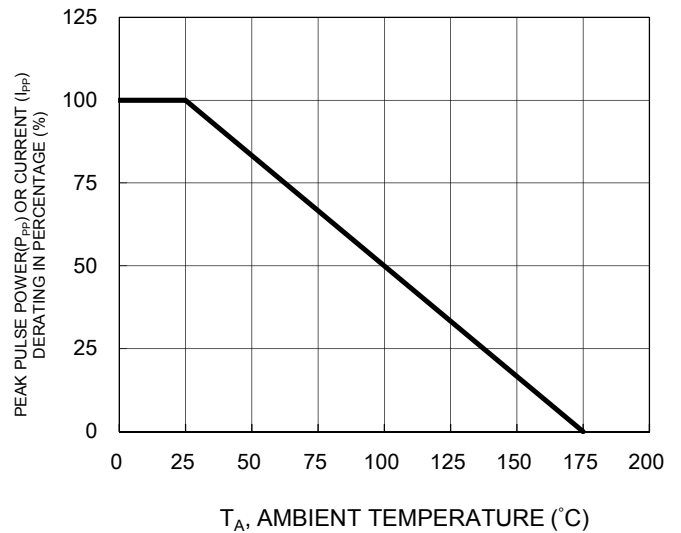

Fig3. Clamping Power Pulse Waveform

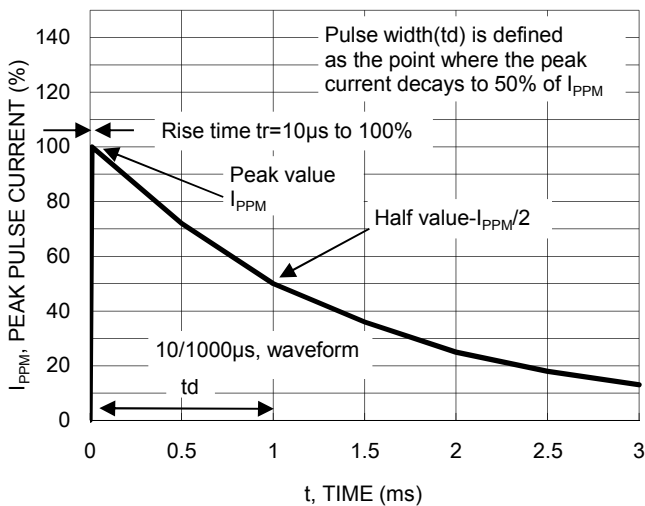

Fig4. Maximum Non-Repetitive Forward Surge Current Unidirectional Only

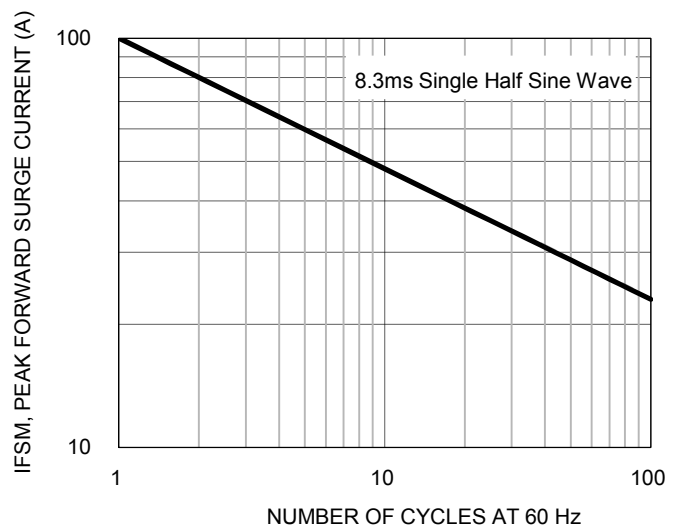
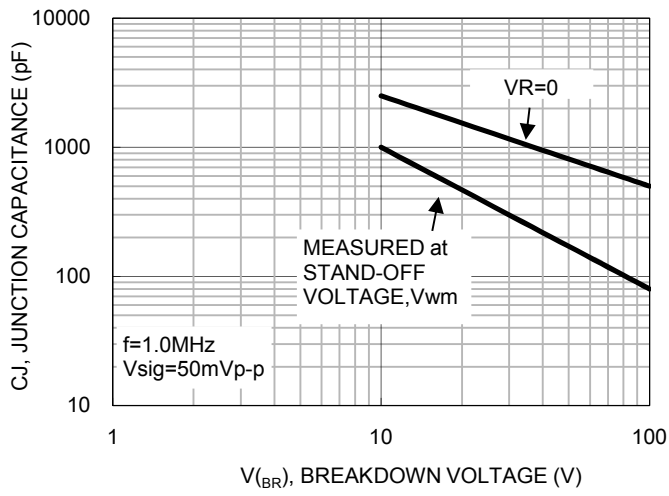
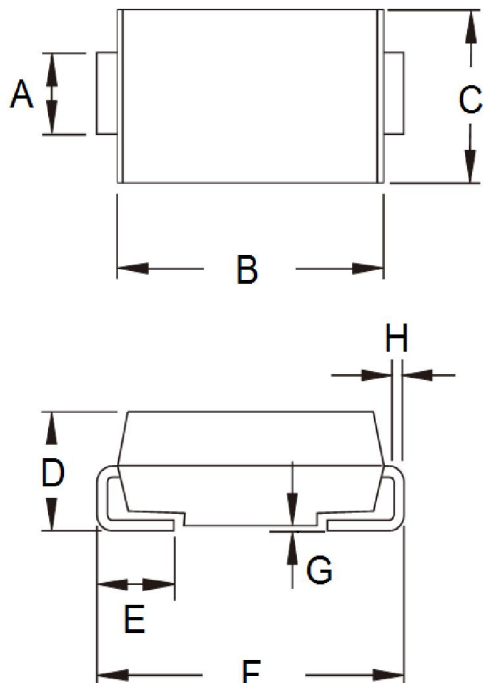

Fig5. Typical Junction Capacitance



PACKAGE OUTLINE DIMENSIONS

DO-214AA (SMB)



DIM.	Unit (mm)		Unit (inch)	
	Min	Max	Min	Max
A	1.95	2.20	0.077	0.087
B	4.05	4.60	0.159	0.181
C	3.30	3.95	0.130	0.156
D	1.95	2.65	0.077	0.104
E	0.75	1.60	0.030	0.063
F	5.10	5.60	0.201	0.220
G	0.05	0.20	0.002	0.008
H	0.15	0.31	0.006	0.012

SUGGESTED PAD LAYOUT

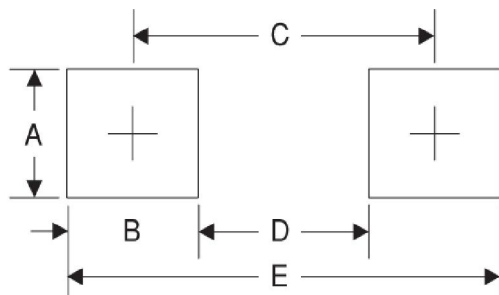

Symbol	Unit (mm)	Unit (inch)
A	2.3	0.091
B	2.5	0.098
C	4.3	0.169
D	1.8	0.071
E	6.8	0.268

MARKING DIAGRAM



- P/N = Marking Code
- G = Green Compound
- YW = Date Code
- F = Factory Code

Notice

Specifications of the products displayed herein are subject to change without notice. TSC or anyone on its behalf, assumes no responsibility or liability for any errors or inaccuracies.

Purchasers are solely responsible for the choice, selection, and use of TSC products and TSC assumes no liability for application assistance or the design of Purchasers' products.

Information contained herein is intended to provide a product description only. No license, express or implied, to any intellectual property rights is granted by this document. Except as provided in TSC's terms and conditions of sale for such products, TSC assumes no liability whatsoever, and disclaims any express or implied warranty, relating to sale and/or use of TSC products including liability or warranties relating to fitness for a particular purpose, merchantability, or infringement of any patent, copyright, or other intellectual property right.

The products shown herein are not designed for use in medical, life-saving, or life-sustaining applications. Customers using or selling these products for use in such applications do so at their own risk and agree to fully indemnify TSC for any damages resulting from such improper use or sale.

Mouser Electronics

Authorized Distributor

Click to View Pricing, Inventory, Delivery & Lifecycle Information:

Taiwan Semiconductor:

[1KSMB75AHR5G](#) [1KSMB33CAHR5](#) [1KSMB10CA R5G](#) [1KSMB13CAHR5](#) [1KSMB22CA R5G](#) [1KSMB30AHR5G](#)
[1KSMB18A R5G](#) [1KSMB68CAHR5](#) [1KSMB15CAHR5](#) [1KSMB51AHR4G](#) [1KSMB11A R5G](#) [1KSMB10A R5G](#)
[1KSMB39AHR5G](#) [1KSMB27A R5G](#) [1KSMB100AHR4G](#) [1KSMB24CA R5G](#) [1KSMB33AHR5](#) [1KSMB43AHR4G](#)
[1KSMB22CAHR4G](#) [1KSMB30CAHR4G](#) [1KSMB36CA R5G](#) [1KSMB82CAHR5G](#) [1KSMB18AHR5G](#)
[1KSMB100AHR5G](#) [1KSMB82AHR5](#) [1KSMB68AHR4G](#) [1KSMB12A R5G](#) [1KSMB56AHR5](#) [1KSMB75A R5G](#)
[1KSMB10CAHR4G](#) [1KSMB27CAHR5G](#) [1KSMB10AHR4G](#) [1KSMB11CAHR4G](#) [1KSMB15AHR5](#) [1KSMB36CAHR5](#)
[1KSMB91AHR5](#) [1KSMB43CAHR5G](#) [1KSMB68A R5G](#) [1KSMB62CA R5G](#) [1KSMB36CAHR4G](#) [1KSMB47A R5G](#)
[1KSMB13AHR5G](#) [1KSMB22AHR5G](#) [1KSMB24AHR4G](#) [1KSMB13AHR4G](#) [1KSMB100CAHR4G](#) [1KSMB39CA R4](#)
[1KSMB56CAHR5G](#) [1KSMB62AHR4G](#) [1KSMB13A R5G](#) [1KSMB68AHR5G](#) [1KSMB30CAHR5](#) [1KSMB56CA R5G](#)
[1KSMB33CA R5G](#) [1KSMB36AHR4G](#) [1KSMB91CAHR5G](#) [1KSMB75CAHR4G](#) [1KSMB11AHR5G](#) [1KSMB18AHR4G](#)
[1KSMB82CA R5G](#) [1KSMB56AHR4G](#) [1KSMB91CAHR5](#) [1KSMB27CAHR4G](#) [1KSMB91AHR4G](#) [1KSMB24CAHR5](#)
[1KSMB36AHR5G](#) [1KSMB56AHR5G](#) [1KSMB82A R5G](#) [1KSMB82CAHR5](#) [1KSMB10CAHR5G](#) [1KSMB30AHR4G](#)
[1KSMB43CAHR5](#) [1KSMB62CAHR5G](#) [1KSMB39AHR4G](#) [1KSMB22A R5G](#) [1KSMB13CAHR5G](#) [1KSMB27AHR5](#)
[1KSMB62AHR5](#) [1KSMB22AHR4G](#) [1KSMB16CAHR5](#) [1KSMB12CA R5G](#) [1KSMB51CAHR5G](#) [1KSMB24AHR5G](#)
[1KSMB43AHR5G](#) [1KSMB68CAHR4G](#) [1KSMB13AHR5](#) [1KSMB39A R5G](#) [1KSMB47CAHR5G](#) [1KSMB39CAHR4G](#)
[1KSMB100CA R5G](#) [1KSMB20CAHR5](#) [1KSMB39CAHR5](#) [1KSMB11AHR5](#) [1KSMB91AHR5G](#) [1KSMB62CAHR5](#)
[1KSMB20AHR5](#) [1KSMB24A R5G](#) [1KSMB18CA R5G](#) [1KSMB24CAHR4G](#) [1KSMB39A R4](#)