

Dual Common Cathode Schottky Rectifier

FEATURES

- Low power loss, high efficiency
- Ideal for automated placement
- Guardring for overvoltage protection
- High surge current capability
- Moisture sensitivity level: level 1, per J-STD-020
- Compliant to RoHS Directive 2011/65/EU and in accordance to WEEE 2002/96/EC
- Halogen-free according to IEC 61249-2-21 definition

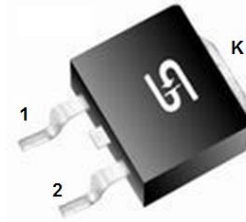

MECHANICAL DATA

Case: TO-263AB (D²PAK)

Molding compound, UL flammability classification rating 94V-0

Base P/N with suffix "G" on packing code - halogen-free

Base P/N with prefix "H" on packing code - AEC-Q101 qualified

Terminal: Matte tin plated leads, solderable per JESD22-B102

Meet JESD 201 class 1A whisker test

with prefix "H" on packing code meet JESD 201 class 2 whisker test

Polarity: As marked

Weight: 1.37 g (approximately)

TO-263AB (D²PAK)

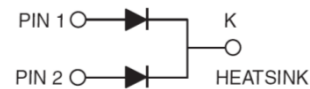

MAXIMUM RATINGS AND ELECTRICAL CHARACTERISTICS (T _A =25°C unless otherwise noted)									
PARAMETER	SYMBOL	MBRS 2535 CT	MBRS 2545 CT	MBRS 2550 CT	MBRS 2560 CT	MBRS 2590 CT	MBRS 25100 CT	MBRS 25150 CT	Unit
Maximum repetitive peak reverse voltage	V _{RRM}	35	45	50	60	90	100	150	V
Maximum RMS voltage	V _{RMS}	24	31	35	42	63	70	105	V
Maximum DC blocking voltage	V _{DC}	35	45	50	60	90	100	150	V
Maximum average forward rectified current	I _{F(AV)}	25							A
Peak repetitive forward current (Rated VR, Square wave, 20KHz)	I _{FRM}	25							A
Peak forward surge current, 8.3 ms single half sine-wave superimposed on rated load	I _{FSM}	200							A
Peak repetitive reverse surge current (Note 1)	I _{RRM}	1		0.5					A
Maximum instantaneous forward voltage (Note 2) I _F =12.5A @ 25°C I _F =12.5A @ 125°C I _F =25.0A @ 25°C I _F =25.0A @ 125°C	V _F	0.65		0.75		0.85		0.95	V
		0.55		0.65		0.75		0.92	
		0.82		0.90		0.92		1.02	
		0.73		0.80		0.88		0.98	
Maximum reverse current @ rated VR T _J =25 °C T _J =125 °C	I _R	0.2		0.2		0.1		0.1	mA
		15		10		7.5		5	
Voltage rate of change (Rated V _R)	dV/dt	10000							V/μs
Typical thermal resistance	R _{θJC}	1.0							°C/W
Operating junction temperature range	T _J	- 55 to +150							°C
Storage temperature range	T _{STG}	- 55 to +150							°C

Note 1: tp = 2.0 μs, 1.0KHz

Note 2: Pulse test with PW=300μs, 1% duty cycle

ORDERING INFORMATION					
PART NO.	AEC-Q101 QUALIFIED	PACKING CODE	GREEN COMPOUND CODE	PACKAGE	PACKING
MBRS25xxCT (Note 1)	Prefix "H"	RN	Suffix "G"	D ² PAK	800 / 13" Paper reel
		C0		D ² PAK	50 / Tube

Note 1: "xx" defines voltage from 35V (MBRS2535CT) to 150V (MBRS25150CT)

EXAMPLE					
PREFERRED P/N	PART NO.	AEC-Q101 QUALIFIED	PACKING CODE	GREEN COMPOUND CODE	DESCRIPTION
MBRS2560CT RN	MBRS2560CT		RN		
MBRS2560CT RNG	MBRS2560CT		RN	G	Green compound
MBRS2560CTHRN	MBRS2560CT	H	RN		AEC-Q101 qualified

RATINGS AND CHARACTERISTICS CURVES

(TA=25°C unless otherwise noted)

FIG. 1 FORWARD CURRENT DERATING CURVE

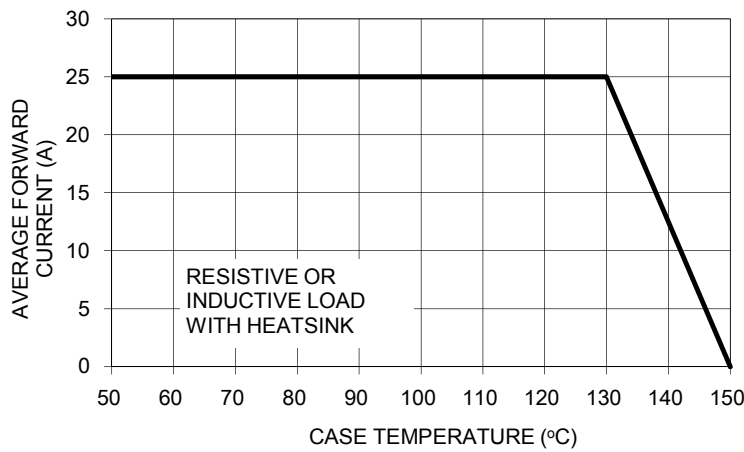

FIG. 2 MAXIMUM NON-REPETITIVE FORWARD SURGE CURRENT PER LEG

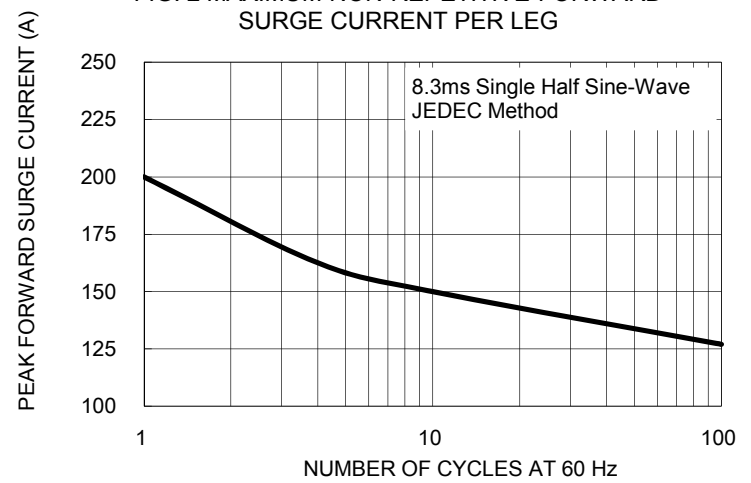

FIG. 3 TYPICAL FORWARD CHARACTERISTICS PER LEG

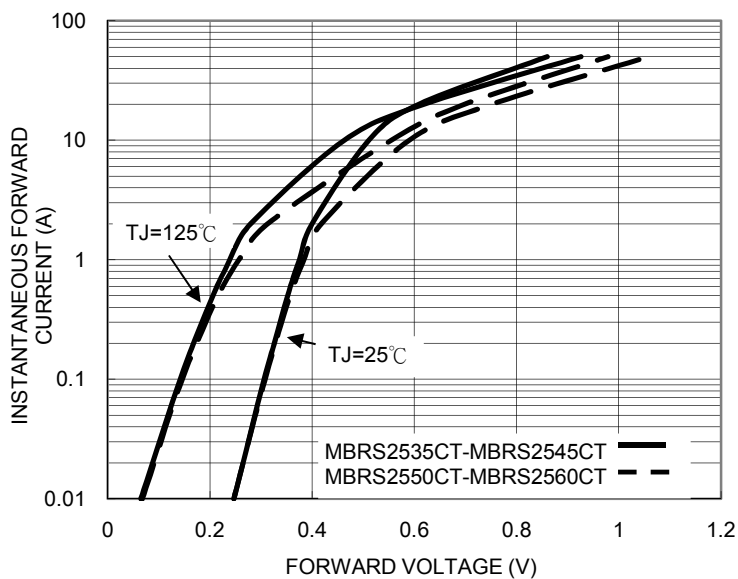

FIG. 4 TYPICAL FORWARD CHARACTERISTICS PER LEG

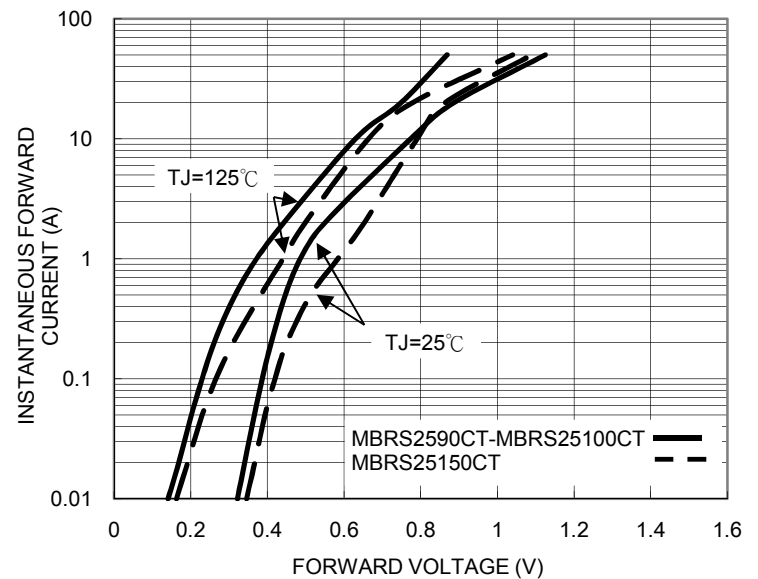

FIG. 5 TYPICAL REVERSE CHARACTERISTICS PER LEG

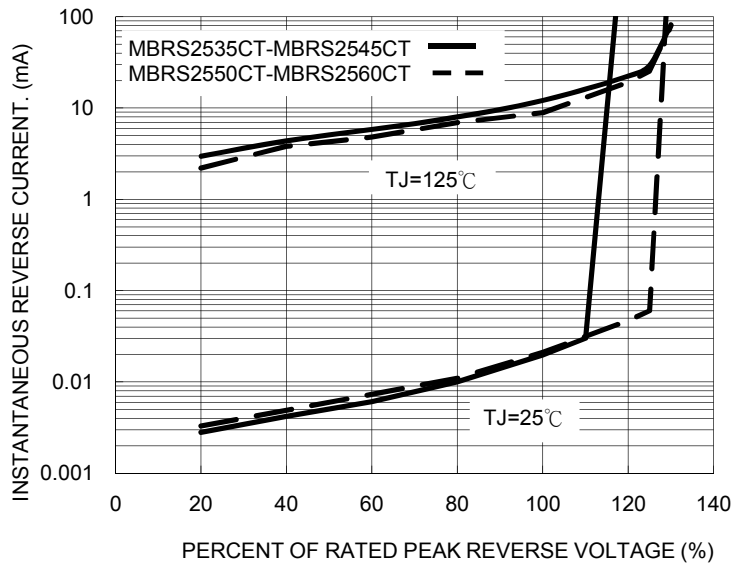

FIG. 6 TYPICAL REVERSE CHARACTERISTICS PER LEG

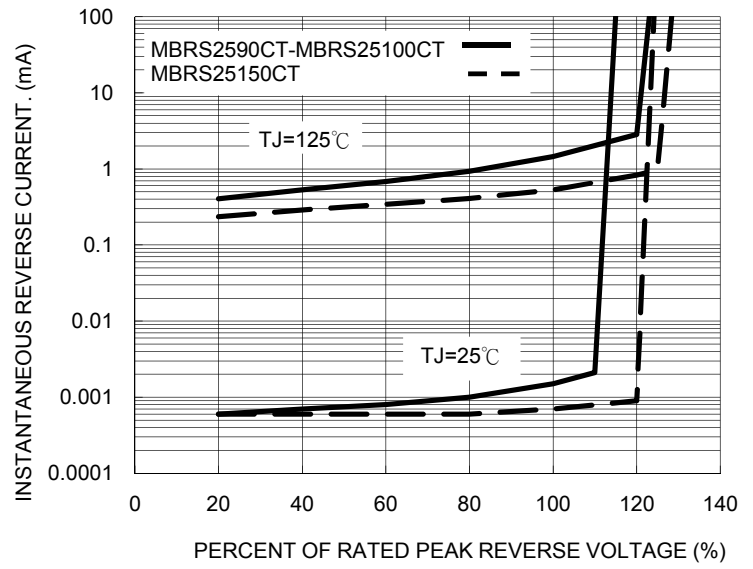

FIG. 7 TYPICAL JUNCTION CAPACITANCE PER LEG

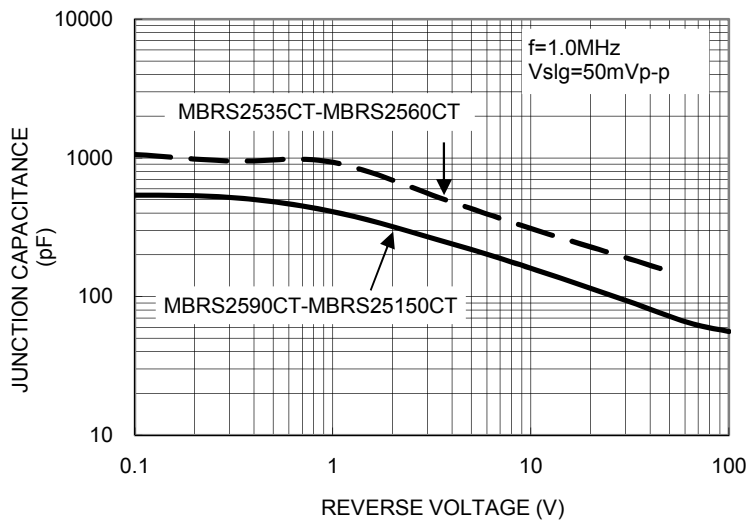
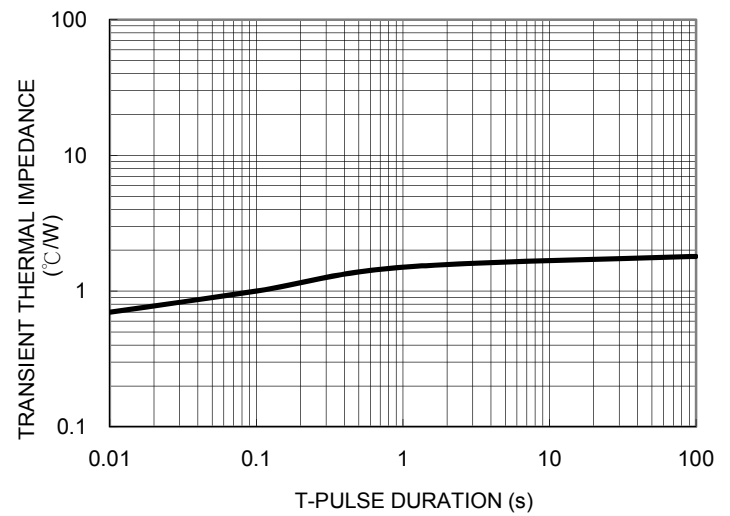
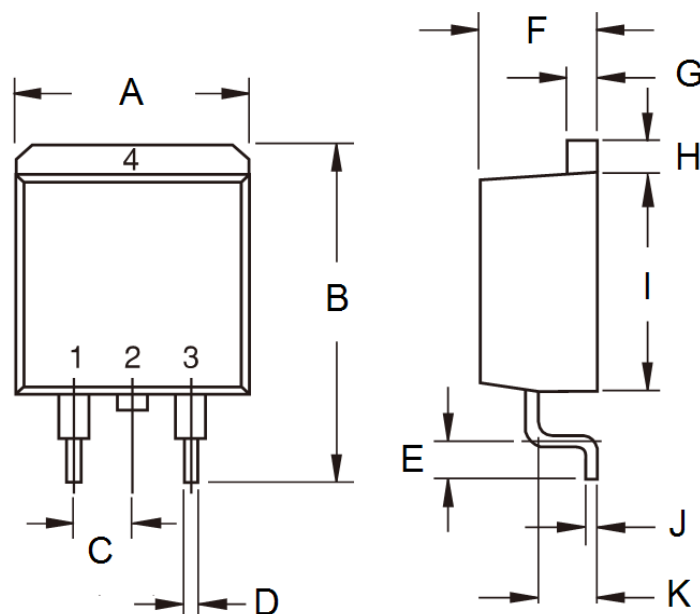

FIG. 8 TYPICAL TRANSIENT THERMAL IMPEDANCE PER LEG



PACKAGE OUTLINE DIMENSIONS



DIM.	Unit (mm)		Unit (inch)	
	Min	Max	Min	Max
A	-	10.5	-	0.413
B	14.60	15.88	0.575	0.625
C	2.41	2.67	0.095	0.105
D	0.68	0.94	0.027	0.037
E	2.29	2.79	0.090	0.110
F	4.44	4.70	0.175	0.185
G	1.14	1.40	0.045	0.055
H	1.14	1.40	0.045	0.055
I	8.25	9.25	0.325	0.364
J	0.36	0.53	0.014	0.021
K	2.03	2.79	0.080	0.110

SUGGESTED PAD LAYOUT

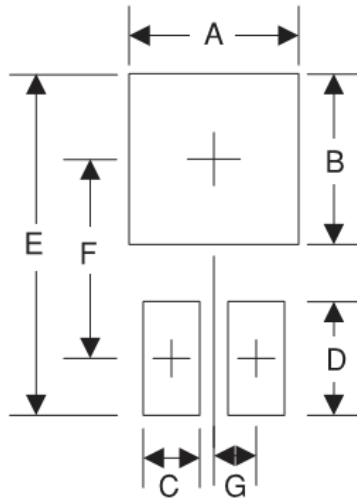

Symbol	Unit (mm)	Unit (inch)
A	10.8	0.425
B	8.3	0.327
C	1.1	0.043
D	3.5	0.138
E	16.9	0.665
F	9.5	0.374
G	2.5	0.098

MARKING DIAGRAM

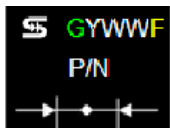

- P/N = Specific Device Code
- G = Green Compound
- YWW = Date Code
- F = Factory Code

Notice

Specifications of the products displayed herein are subject to change without notice. TSC or anyone on its behalf, assumes no responsibility or liability for any errors inaccuracies.

Information contained herein is intended to provide a product description only. No license, express or implied, to any intellectual property rights is granted by this document. Except as provided in TSC's terms and conditions of sale for such products, TSC assumes no liability whatsoever, and disclaims any express or implied warranty, relating to sale and/or use of TSC products including liability or warranties relating to fitness for a particular purpose, merchantability, or infringement of any patent, copyright, or other intellectual property right.

The products shown herein are not designed for use in medical, life-saving, or life-sustaining applications. Customers using or selling these products for use in such applications do so at their own risk and agree to fully indemnify TSC for any damages resulting from such improper use or sale.

Mouser Electronics

Authorized Distributor

Click to View Pricing, Inventory, Delivery & Lifecycle Information:

[Taiwan Semiconductor:](#)

[MBRS25100CTHRN](#) [MBRS2550CTHRN](#) [MBRS2590CTHRN](#) [MBRS2535CTHRN](#) [MBRS2590CT RN](#)