

## Trench Schottky Rectifier

### FEATURES

- Patented Trench Schottky technology
- Excellent high temperature stability
- Low forward voltage
- Low power loss/ high efficiency
- High forward surge capability
- Compliant to RoHS directive 2011/65/EU and in accordance to WEEE 2002/96/EC
- Halogen-free according to IEC 61249-2-21 definition



**TO-220AB**

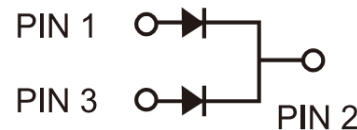

### TYPICAL APPLICATIONS

Trench Schottky barrier rectifier are designed for high frequency miniature switched mode power supplies such as adapters, lighting and on-board DC/DC converters.

### MECHANICAL DATA

**Case:** TO-220AB

Molding compound meets UL 94 V-0 flammability rating

Packing code with suffix "G" means green compound (halogen-free)

**Terminal:** Matte tin plated leads, solderable per JESD22-B102

Meet JESD 201 class 1A whisker test

**Polarity:** As marked

**Mounting torque:** 0.56 Nm max.

**Weight:** 1.88 g (approximately)

MAXIMUM RATINGS AND ELECTRICAL CHARACTERISTICS (T <sub>A</sub> = 25°C unless otherwise noted)												
PARAMETER		SYMBOL	TST30H 100CW	TST30H 120CW	TST30H 150CW	TST30H 200CW					UNIT	
Maximum repetitive peak reverse voltage		V <sub>RRM</sub>	100	120	150	200					V	
Maximum average forward rectified current	per device	I <sub>F(AV)</sub>	30								A	
	per diode		15									
Peak forward surge current, 8.3 ms single half sine-wave superimposed on rated load per diode		I <sub>FSM</sub>	200								A	
Voltage rate of change (Rated V <sub>R</sub> )		dV/dt	10000								V/μs	
			TYP	MAX	TYP	MAX	TYP	MAX	TYP	MAX		
Instantaneous forward voltage per diode (Note1)	I <sub>F</sub> = 15A	T <sub>J</sub> = 25°C	V <sub>F</sub>	0.69	0.78	0.75	0.88	0.81	0.90	0.84	0.92	V
		T <sub>J</sub> = 125°C		0.61	0.68	0.64	0.75	0.68	0.77	0.70	0.79	
Instantaneous reverse current per diode at rated reverse voltage		T <sub>J</sub> = 25°C	I <sub>R</sub>	-	250	-	250	-	150	-	150	μA
		T <sub>J</sub> = 125°C		10	35	10	35	3	20	3	20	mA
Typical thermal resistance per diode		R <sub>θJC</sub>	2.2			3					°C/W	
Operating junction temperature range		T <sub>J</sub>	- 55 to +150								°C	
Storage temperature range		T <sub>STG</sub>	- 55 to +150								°C	

Note 1: Pulse test with pulse width=300μs, 1% duty cycle

**ORDERING INFORMATION**

PART NO.	PACKING CODE	PACKING CODE SUFFIX	PACKAGE	PACKING
TST30HXXCW (Note 1)	C0	G	TO-220AB	50 / Tube

Note 1: "XXX" defines voltage from 100V (TST30H100CW) to 200V (TST30H200CW)

**EXAMPLE**

PREFERRED PART NO.	PART NO.	PACKING CODE	PACKING CODE SUFFIX	DESCRIPTION
TST30H120CW C0G	TST30H120CW	C0	G	Green compound

**RATINGS AND CHARACTERISTICS CURVES**

( $T_A = 25^\circ\text{C}$  unless otherwise noted)

FIG. 1 FORWARD CURRENT DERATING CURVE

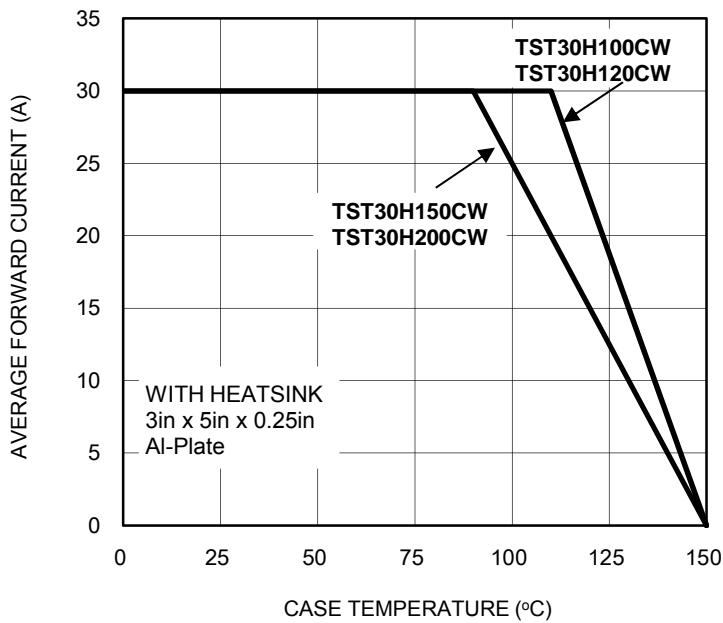

FIG. 2 TYPICAL FORWARD CHARACTERISTICS

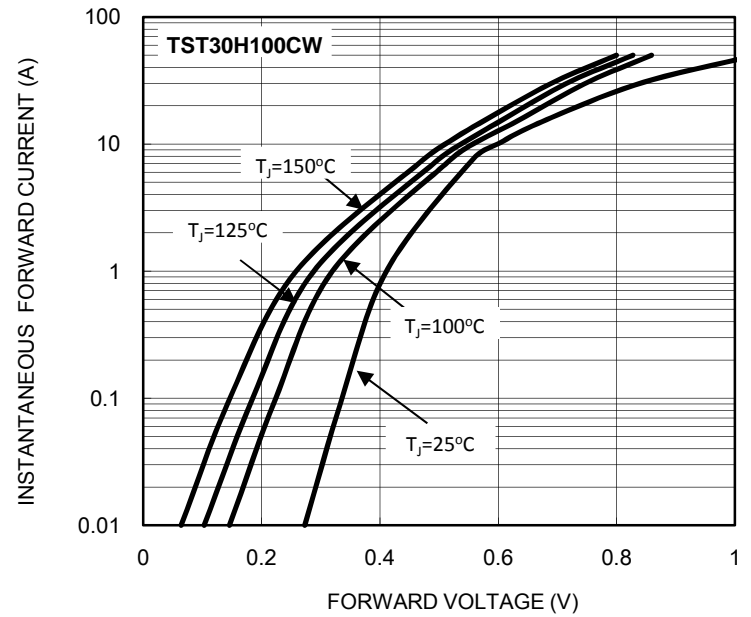

FIG. 3 TYPICAL FORWARD CHARACTERISTICS

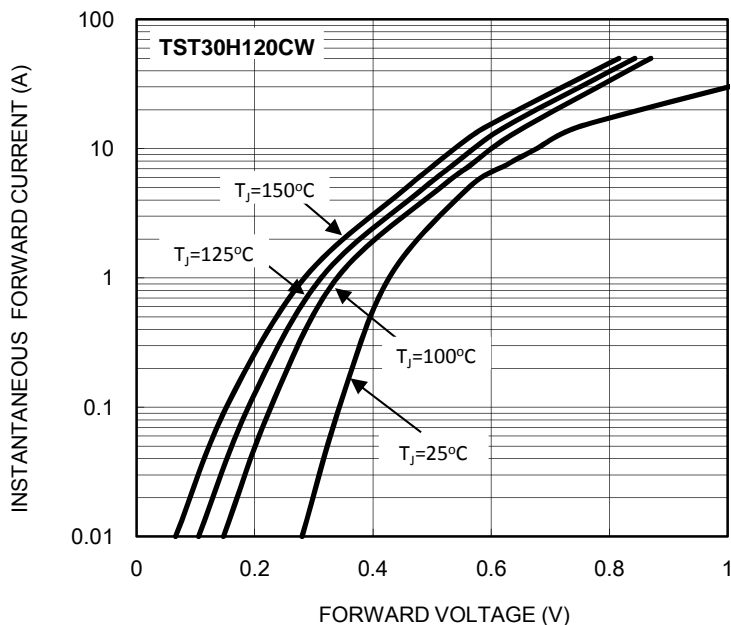

FIG. 4 TYPICAL FORWARD CHARACTERISTICS

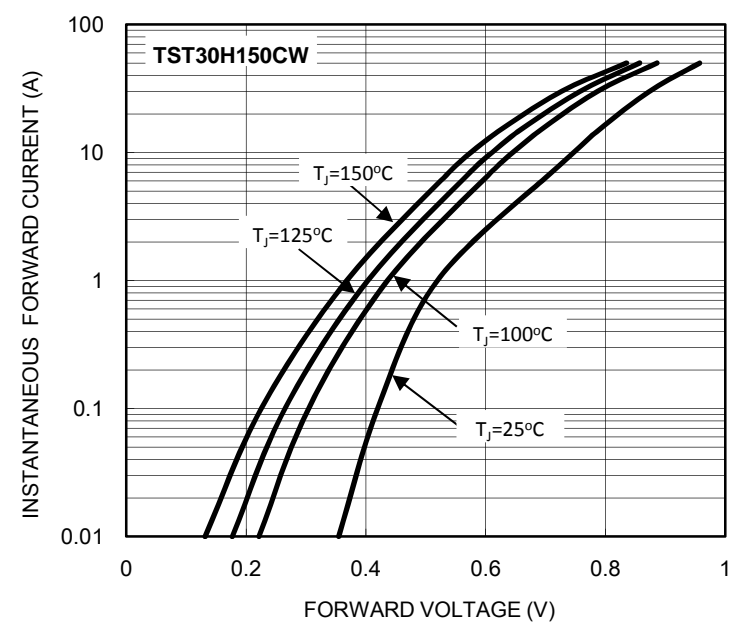

FIG. 5 TYPICAL FORWARD CHARACTERISTICS

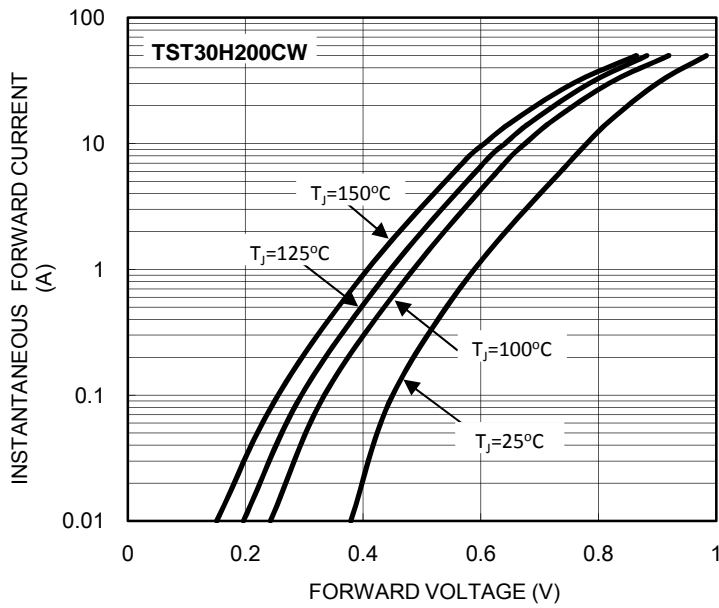

FIG. 6 TYPICAL REVERSE CHARACTERISTICS

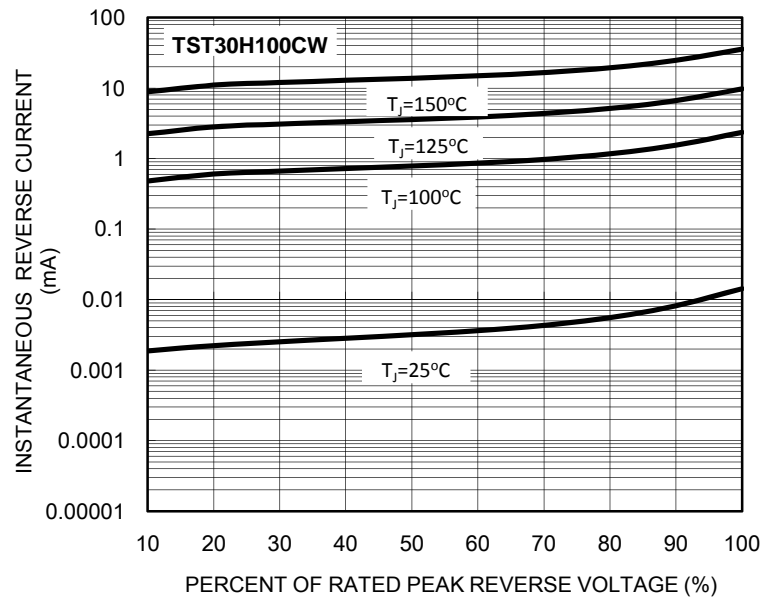

FIG. 7 TYPICAL REVERSE CHARACTERISTICS

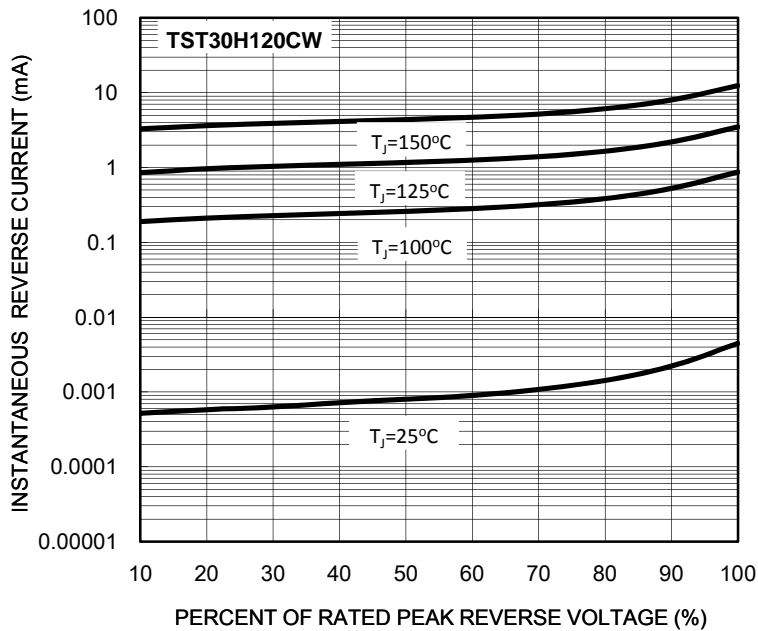

FIG. 8 TYPICAL REVERSE CHARACTERISTICS

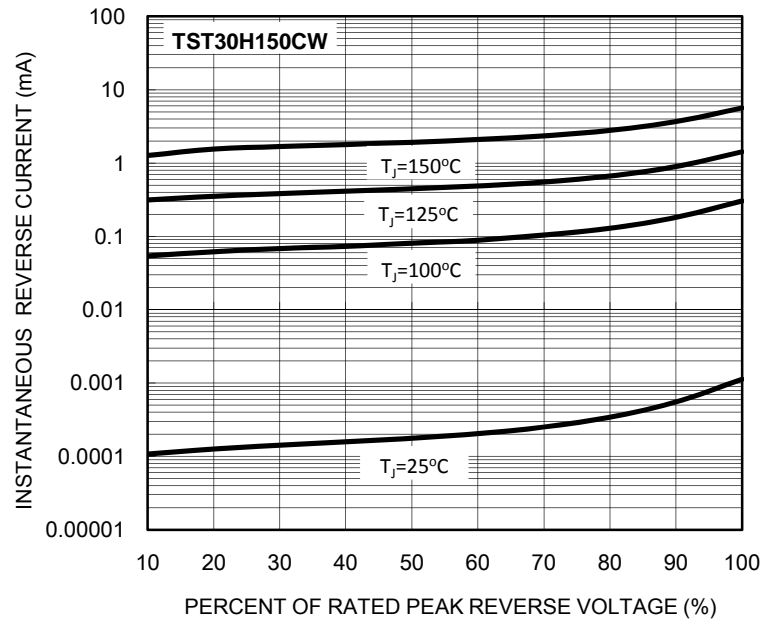

FIG. 9 TYPICAL REVERSE CHARACTERISTICS

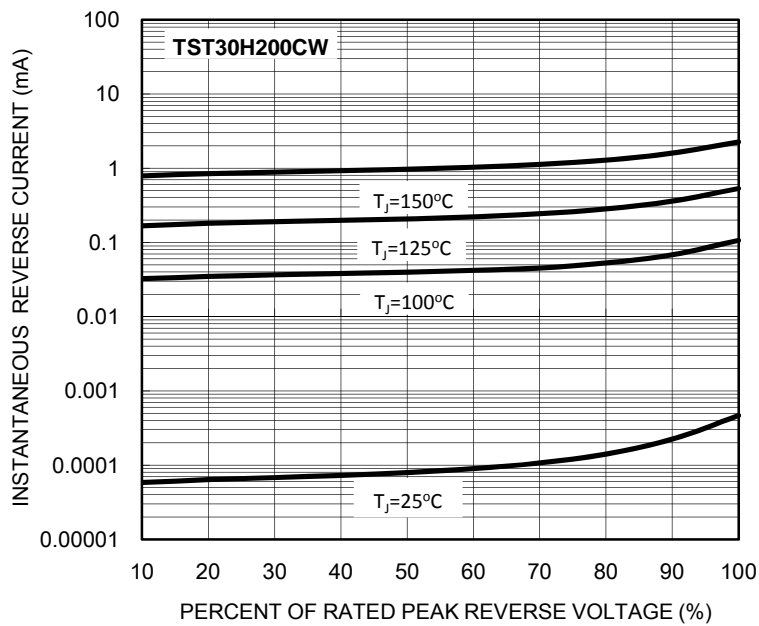
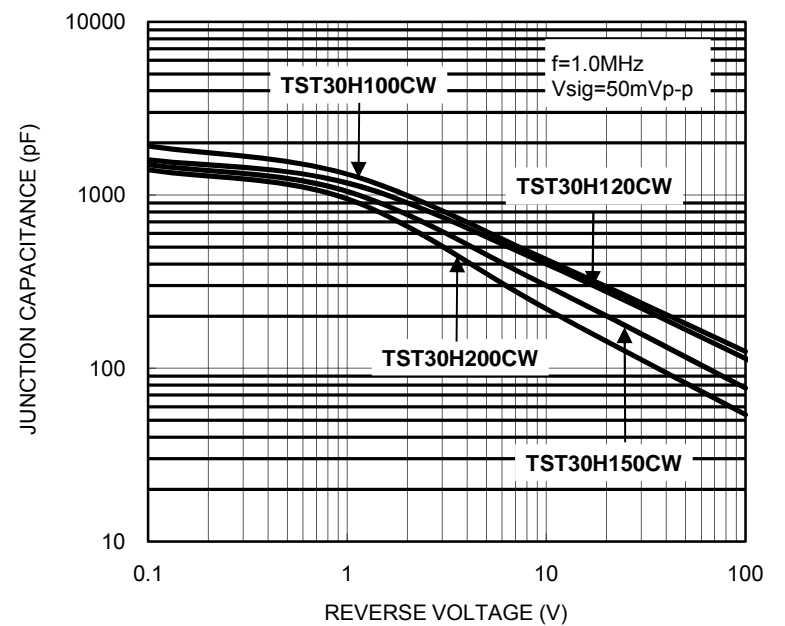
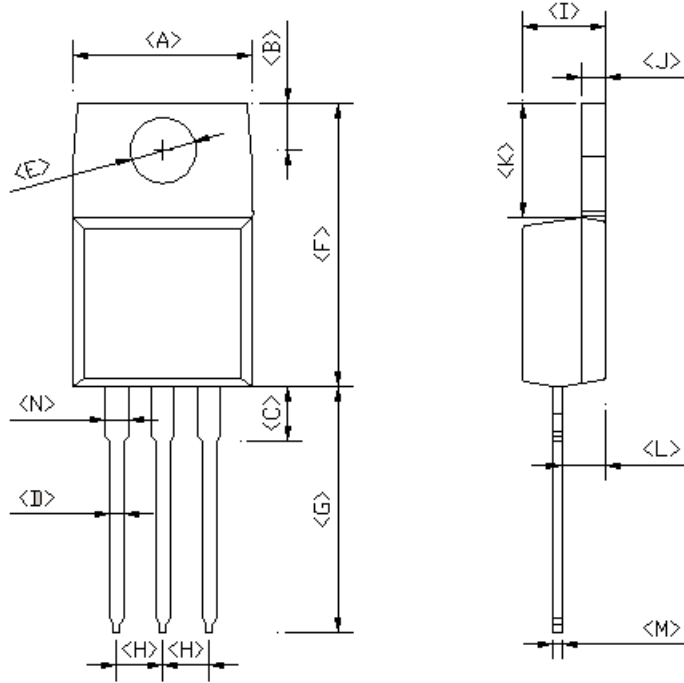

FIG. 10 TYPICAL JUNCTION CAPACTIANCE



PACKAGE OUTLINE DIMENSIONS  
**TO-220AB**



DIM.	Unit (mm)		Unit (inch)	
	Min	Max	Min	Max
A	-	10.50	-	0.413
B	2.54	3.44	0.100	0.135
C	2.80	4.20	0.110	0.165
D	0.68	0.94	0.027	0.037
E	3.54	4.00	0.139	0.157
F	14.60	16.00	0.575	0.630
G	13.19	14.79	0.519	0.582
H	2.41	2.67	0.095	0.105
I	4.42	4.76	0.174	0.187
J	1.14	1.40	0.045	0.055
K	5.84	6.86	0.230	0.270
L	2.20	2.80	0.087	0.110
M	0.35	0.64	0.014	0.025
N	0.95	1.45	0.037	0.057

MARKING DIAGRAM



P/N = Specific Device Code  
 G = Green Compound  
 YWW = Date Code  
 F = Factory Code

### Notice

Specifications of the products displayed herein are subject to change without notice. TSC or anyone on its behalf, assumes no responsibility or liability for any errors or inaccuracies.

Information contained herein is intended to provide a product description only. No license, express or implied, to any intellectual property rights is granted by this document. Except as provided in TSC's terms and conditions of sale for such products, TSC assumes no liability whatsoever, and disclaims any express or implied warranty, relating to sale and/or use of TSC products including liability or warranties relating to fitness for a particular purpose, merchantability, or infringement of any patent, copyright, or other intellectual property right.

The products shown herein are not designed for use in medical, life-saving, or life-sustaining applications. Customers using or selling these products for use in such applications do so at their own risk and agree to fully indemnify TSC for any damages resulting from such improper use or sale.

# Mouser Electronics

Authorized Distributor

Click to View Pricing, Inventory, Delivery & Lifecycle Information:

[Taiwan Semiconductor:](#)

[TST30H100CW COG](#) [TST30H120CW COG](#)