

## Glass Passivated Bridge Rectifiers

### FEATURES

- Ideal for automated placement
- Reliable low cost construction utilizing molded plastic technique
- High surge current capability
- Moisture sensitivity level: level 1, per J-STD-020
- UL Recognized File # E-326854
- Compliant to RoHS Directive 2011/65/EU and in accordance to WEEE 2002/96/EC
- Halogen-free according to IEC 61249-2-21 definition
- AEC-Q101 qualified

**MBS**

### MECHANICAL DATA

**Case:** Molded plastic body

Molding compound, UL flammability classification rating 94V-0

Packing code with suffix "G" means green compound (halogen-free)

**Terminal:** Matte tin plated leads, solderable per JESD22-B102

Meet JESD 201 class 2 whisker test

**Polarity:** Polarity as marked on the body

**Weight:** 0.12 g (approximately)

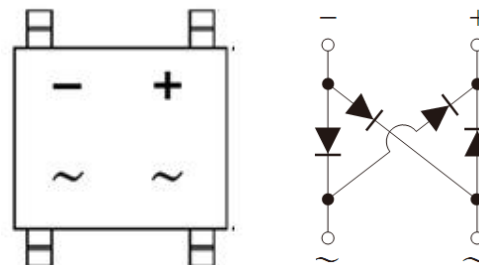

### MAXIMUM RATINGS AND ELECTRICAL CHARACTERISTICS (T<sub>A</sub>=25°C unless otherwise noted)

PARAMETER	SYMBOL	MBS2	MBS4	MBS6	MBS8	MBS10	Unit
Maximum repetitive peak reverse voltage	V <sub>RRM</sub>	200	400	600	800	1000	V
Maximum RMS voltage	V <sub>RMS</sub>	140	280	420	560	700	V
Maximum DC blocking voltage	V <sub>DC</sub>	200	400	600	800	1000	V
Maximum average forward rectified current On glass-epoxy P.C.B. On aluminum substrate	I <sub>F(AV)</sub>			0.5 0.8			A
Peak forward surge current, 8.3 ms single half sine-wave superimposed on rated load	I <sub>FSM</sub>			35			A
Maximum instantaneous forward voltage (Note 1) I <sub>F</sub> = 0.4 A	V <sub>F</sub>			1.0			V
Maximum DC reverse current at rated DC blocking voltage	I <sub>R</sub>			5 100			μA
							T <sub>J</sub> =25 °C T <sub>J</sub> =125 °C
Rating for fusing (t<8.3ms)	I <sup>2</sup> t			5.08			A <sup>2</sup> s
Typical junction capacitance per leg (Note 2)	C <sub>J</sub>			13			pF
							(Note 3)
Typical thermal resistance (Note 4)	R <sub>θJL</sub>			20			°C/W
	R <sub>θJA</sub>			70			
	R <sub>θJA</sub>			85			
Operating junction temperature range	T <sub>J</sub>			- 55 to +150			°C
Storage temperature range	T <sub>STG</sub>			- 55 to +150			°C

Note 1: Pulse Test with PW=300μs, 1% Duty Cycle

Note 2: Measure at 1.0MHz and Applied Reverse Voltage of 4.0 Volts D.C.

Note 3: On glass epoxy P.C.B. mounted on 0.05" x 0.05" (1.3mm x 1.3mm) pads

Note 4: On aluminum substrate P.C.B. with an area of 0.8" x 0.8" (20mm x 20mm) mounted on 0.05" x 0.05" (1.3mm x 1.3mm) solder pads

**ORDERING INFORMATION**

PART NO.	PACKING CODE	PACKING CODE SUFFIX	PACKAGE	PACKING
MBSx (Note 1, 2)	RC	G	MBS	3,000 / 13" Paper reel

Note 1: "x" defines voltage from 200V (MBS2) to 1000V (MBS10)

Note 2: Whole series with green compound

**EXAMPLE**

PREFERRED PART NO.	PART NO.	PACKING CODE	PACKING CODE SUFFIX	DESCRIPTION
MBS10 RCG	MBS10	RC	G	AEC-Q101 qualified Green compound

**RATINGS AND CHARACTERISTICS CURVES**

(T<sub>A</sub>=25°C unless otherwise noted)

FIG. 1 MAXIMUM FORWARD CURRENT DERATING CURVE

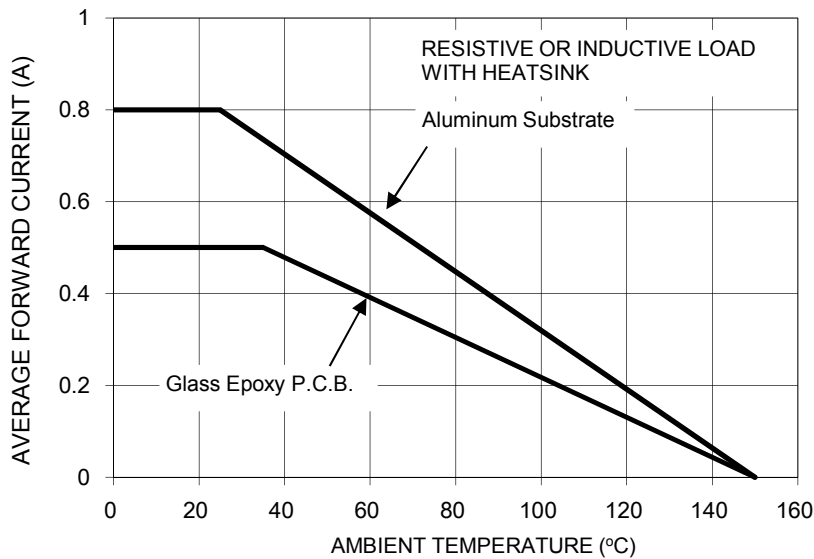

FIG. 2 TYPICAL REVERSE CHARACTERISTICS PER LEG

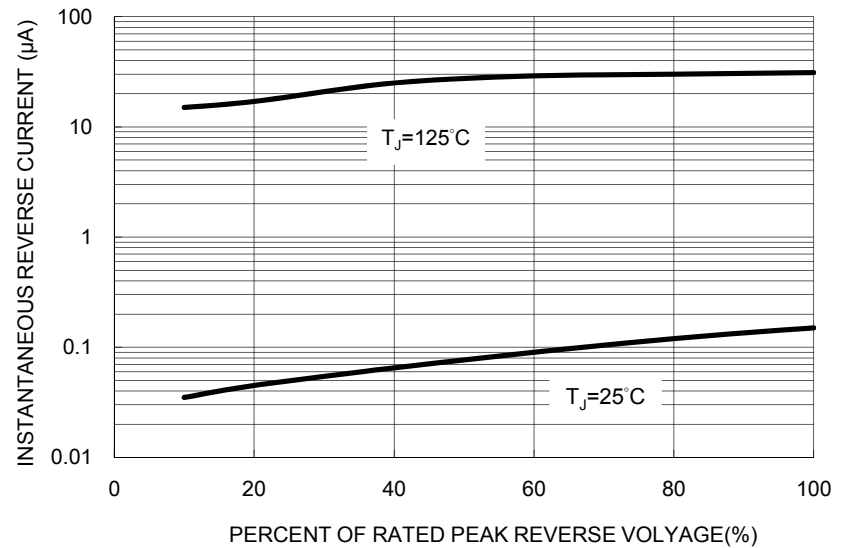

FIG. 3 MAXIMUM NON-REPETITIVE FORWARD SURGE CURRENT PER LEG

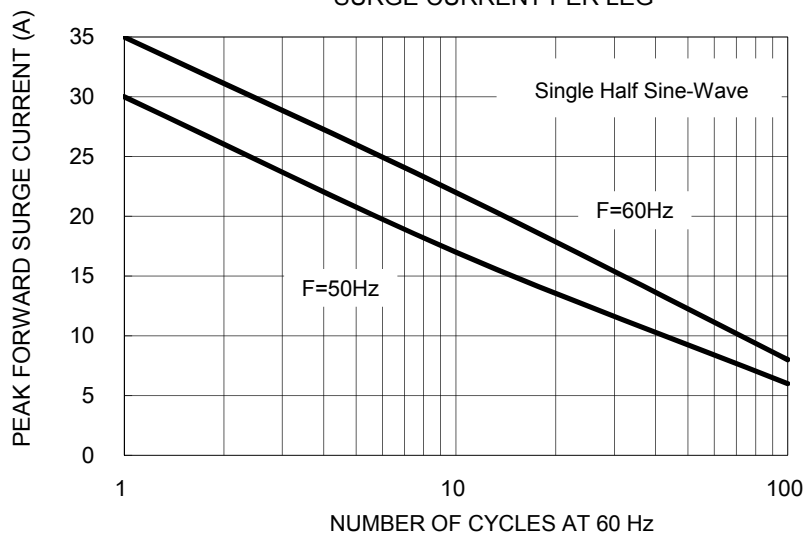

FIG. 4 TYPICAL FORWARD CHARACTERISTICS PER LEG

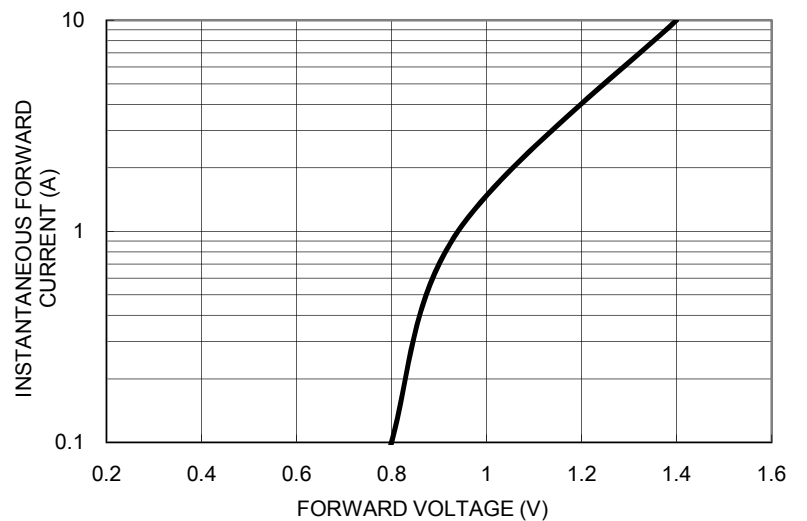
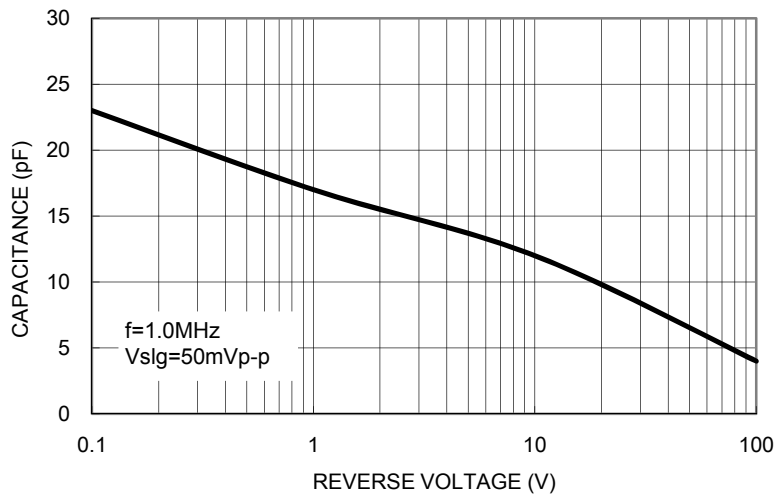
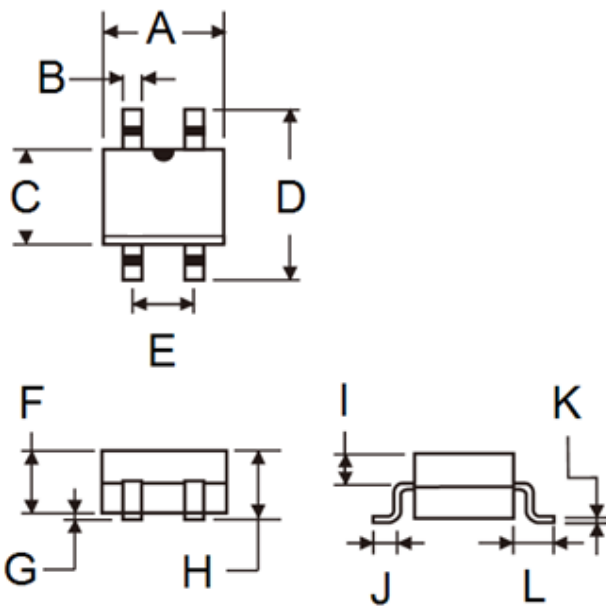

FIG. 5 TYPICAL JUNCTION CAPACITANCE PER LEG



PACKAGE OUTLINE DIMENSIONS

**MBS**



DIM.	Unit (mm)		Unit (inch)	
	Min	Max	Min	Max
A	4.50	4.90	0.177	0.193
B	0.56	0.84	0.022	0.033
C	3.60	5.00	0.142	0.197
D	-	6.90	-	0.272
E	2.20	2.60	0.087	0.102
F	2.30	2.70	0.091	0.106
G	-	0.20	-	0.008
H	-	2.90	-	0.114
I	0.95	1.53	0.037	0.060
J	0.70	1.10	0.028	0.043
K	0.15	0.35	0.006	0.014
L	1.10	2.12	0.043	0.083

SUGGESTED PAD LAYOUT

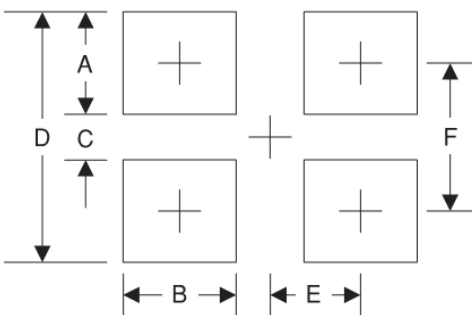

Symbol	Unit (mm)	Unit (inch)
A	1.7	0.067
B	0.9	0.035
C	4.4	0.173
D	8.1	0.319
E	1.3	0.051
F	6.3	0.248

MARKING DIAGRAM



P/N = Specific Device Code  
 YW = Date Code  
 F = Factory Code

## Notice

Specifications of the products displayed herein are subject to change without notice. TSC or anyone on its behalf, assumes no responsibility or liability for any errors or inaccuracies.

Information contained herein is intended to provide a product description only. No license, express or implied, to any intellectual property rights is granted by this document. Except as provided in TSC's terms and conditions of sale for such products, TSC assumes no liability whatsoever, and disclaims any express or implied warranty, relating to sale and/or use of TSC products including liability or warranties relating to fitness for a particular purpose, merchantability, or infringement of any patent, copyright, or other intellectual property right.

The products shown herein are not designed for use in medical, life-saving, or life-sustaining applications. Customers using or selling these products for use in such applications do so at their own risk and agree to fully indemnify TSC for any damages resulting from such improper use or sale.

# Mouser Electronics

Authorized Distributor

Click to View Pricing, Inventory, Delivery & Lifecycle Information:

[Taiwan Semiconductor:](#)

[MBS10](#) [MBS8](#) [MBS4](#) [MBS2](#) [MBS6](#)