

## 1A, 100V-600V Surface Mount Super Fast Rectifiers

### FEATURES

- Glass passivated junction chip
- Ideal for automated placement
- Low power loss, high efficiency
- Low profile package
- RoHS Compliant
- Halogen-free according to IEC 61249-2-21

### APPLICATIONS

- Freewheeling application
- Switching mode converters and inverters, computer and telecommunication.

### MECHANICAL DATA

- Case: SOD-128
- Molding compound meets UL 94V-0 flammability rating
- Moisture sensitivity level: level 1, per J-STD-020
- Terminal: Pure tin plated leads, solderable per J-STD-002
- Meet JESD 201 class 2 whisker test
- Polarity: As marked
- Weight: 0.028 g (approximately)

KEY PARAMETERS		
PARAMETER	VALUE	UNIT
$I_{F(AV)}$	1	A
$V_{RRM}$	100 - 600	V
$I_{FSM}$	30	A
$T_{J\ MAX}$	150	°C
Package	SOD-128	
Configuration	Single Die	



SOD-128

ABSOLUTE MAXIMUM RATINGS ( $T_A = 25^\circ\text{C}$ unless otherwise noted)							
PARAMETER	SYMBOL	ES1BFS	ES1DFS	ES1GFS	ES1JFS	UNIT	
Marking code on the device		ES1BFS	ES1DFS	ES1GFS	ES1JFS		
Repetitive peak reverse voltage	$V_{RRM}$	100	200	400	600	V	
Reverse voltage, total rms value	$V_{R(RMS)}$	70	140	280	420	V	
Forward current	$I_{F(AV)}$	1				A	
Surge peak forward current, single half sine-wave superimposed on rated load per diode	8.3ms at $T_A = 25^\circ\text{C}$	$I_{FSM}$				30	A
	1.0ms at $T_A = 25^\circ\text{C}$					60	A
Junction temperature	$T_J$	-55 to +150				°C	
Storage temperature	$T_{STG}$	-55 to +150				°C	

THERMAL PERFORMANCE			
PARAMETER	SYMBOL	TYP	UNIT
Junction-to-lead thermal resistance	$R_{\theta JL}$	28	°C/W
Junction-to-ambient thermal resistance	$R_{\theta JA}$	67	°C/W
Junction-to-case thermal resistance	$R_{\theta JC}$	20	°C/W

**Thermal Performance Note:** Units mounted on PCB (5mm x 5mm Cu pad test board)

ELECTRICAL SPECIFICATIONS ( $T_A = 25^\circ\text{C}$ unless otherwise noted)						
PARAMETER		CONDITIONS	SYMBOL	TYP	MAX	UNIT
Forward voltage per diode <sup>(1)</sup>	ES1BFS ES1DFS	$I_F = 0.5\text{A}, T_J = 25^\circ\text{C}$	$V_F$	0.80	-	V
		$I_F = 1.0\text{A}, T_J = 25^\circ\text{C}$		0.85	0.95	V
		$I_F = 0.5\text{A}, T_J = 125^\circ\text{C}$		0.58	-	V
		$I_F = 1.0\text{A}, T_J = 125^\circ\text{C}$		0.71	0.81	V
	ES1GFS	$I_F = 0.5\text{A}, T_J = 25^\circ\text{C}$		0.86	-	V
		$I_F = 1.0\text{A}, T_J = 25^\circ\text{C}$		0.93	1.30	V
		$I_F = 0.5\text{A}, T_J = 125^\circ\text{C}$		0.69	-	V
		$I_F = 1.0\text{A}, T_J = 125^\circ\text{C}$		0.77	0.89	V
	ES1JFS	$I_F = 0.5\text{A}, T_J = 25^\circ\text{C}$		1.04	-	V
		$I_F = 1.0\text{A}, T_J = 25^\circ\text{C}$		1.15	1.70	V
		$I_F = 0.5\text{A}, T_J = 125^\circ\text{C}$		0.80	-	V
		$I_F = 1.0\text{A}, T_J = 125^\circ\text{C}$		0.93	1.06	V
Reverse current @ rated $V_R$ per diode <sup>(2)</sup>		$T_J = 25^\circ\text{C}$	$I_R$	-	1	$\mu\text{A}$
		$T_J = 125^\circ\text{C}$		-	20	$\mu\text{A}$
Reverse recovery time		$I_F=0.5\text{A}, I_R=1.0\text{A}, I_{rr}=0.25\text{A}$	$t_{rr}$	-	35	ns
Junction capacitance per diode	ES1BFS ES1DFS	1 MHz, $V_R=4.0\text{V}$	$C_J$	18	-	pF
	ES1GFS			16	-	pF
	ES1JFS			15	-	pF

**Notes:**

- (1) Pulse test with PW=0.3 ms
- (2) Pulse test with PW=30 ms

ORDERING INFORMATION		
ORDERING CODE <sup>(1)</sup>	PACKAGE	PACKING
ES1xFS M3G	SOD-128	3,500 / 7" reel
ES1xFS M2G	SOD-128	14,000 / 13" reel

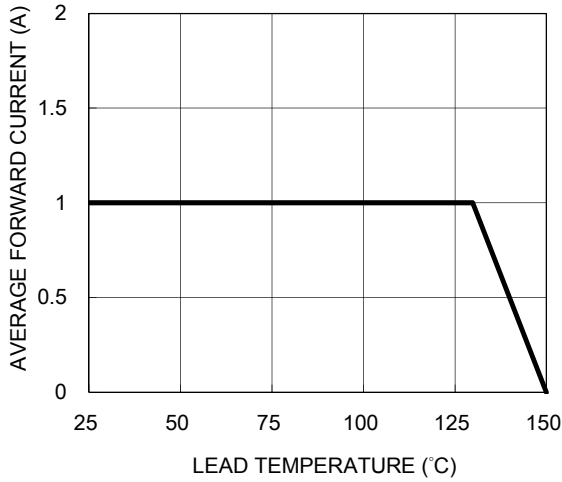
**Notes:**

- (1) "x" defines voltage from 100V(ES1BFS) to 600V(ES1JFS)

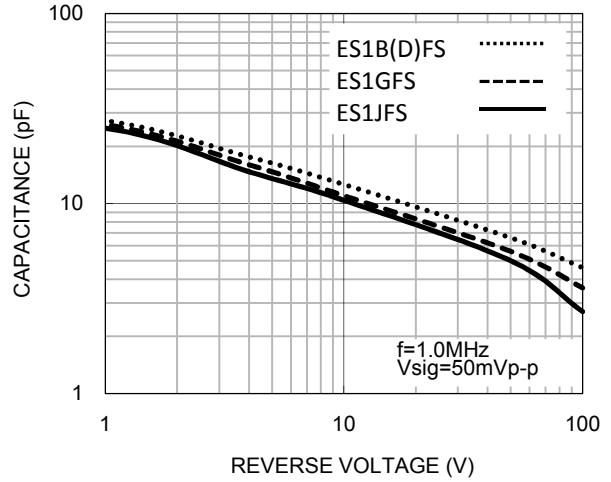
**CHARACTERISTICS CURVES**

( $T_A = 25^\circ\text{C}$  unless otherwise noted)

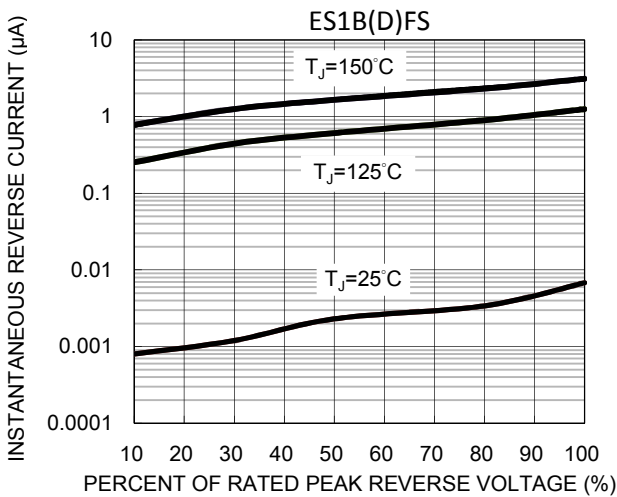
**Fig.1 Forward Current Derating Curve**



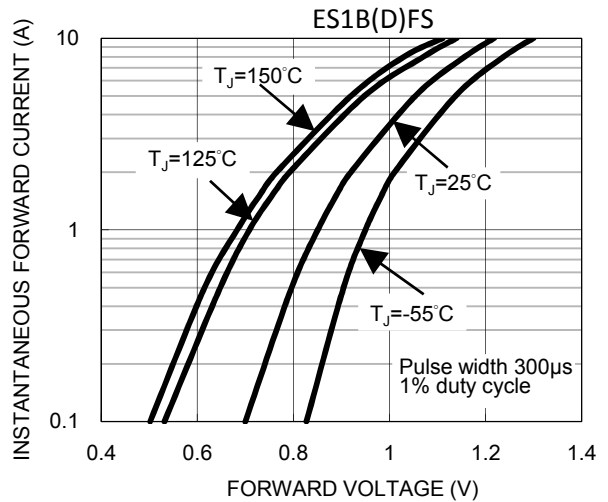
**Fig.2 Typical Junction Capacitance**



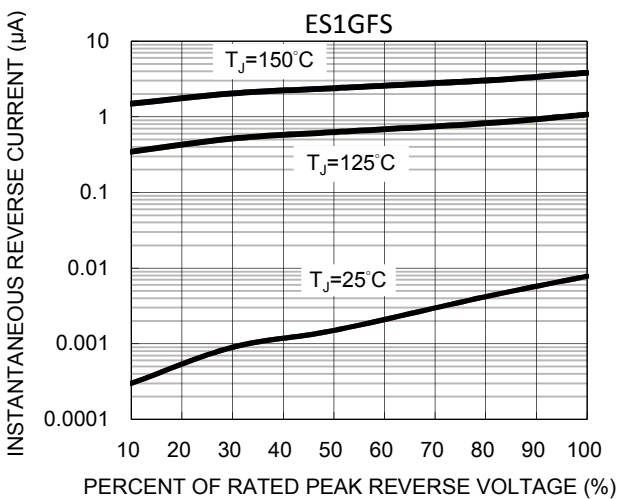
**Fig.3 Typical Reverse Characteristics**



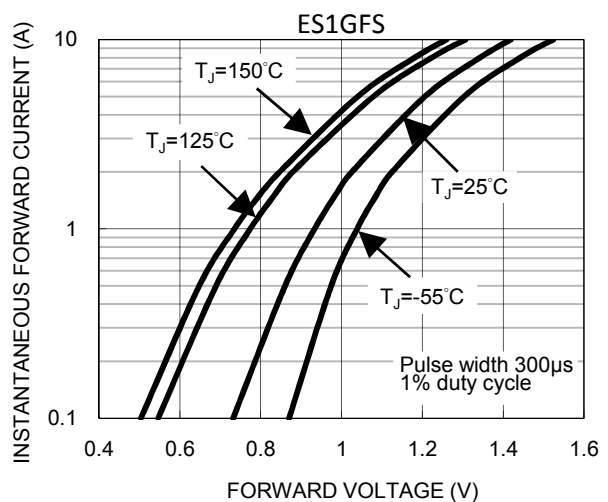
**Fig.4 Typical Forward Characteristics**



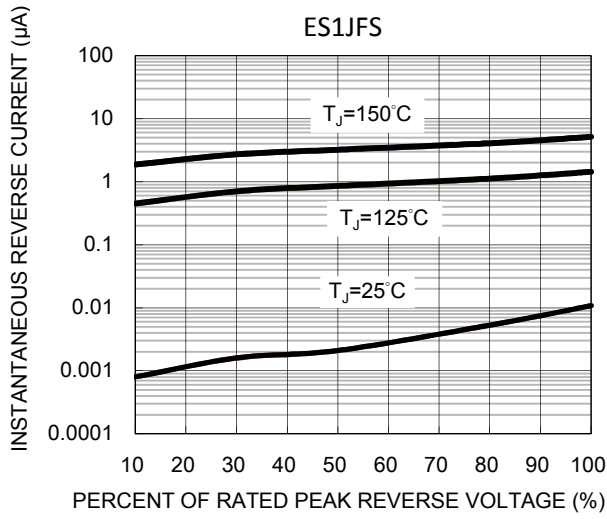
**Fig.5 Typical Reverse Characteristics**



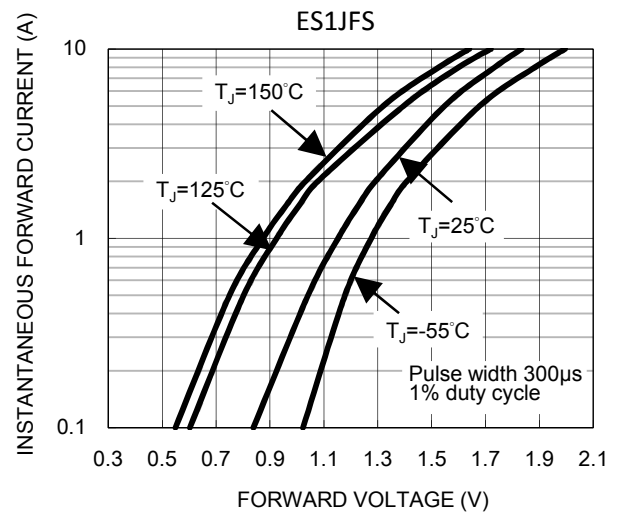
**Fig.6 Typical Forward Characteristics**



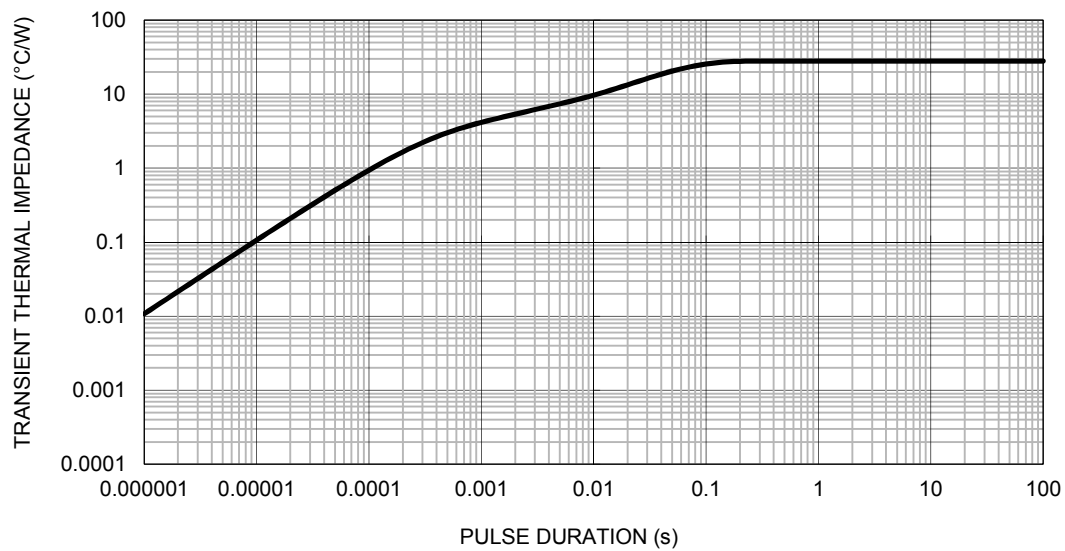
**Fig.7 Typical Reverse Characteristics**



**Fig.8 Typical Forward Characteristics**

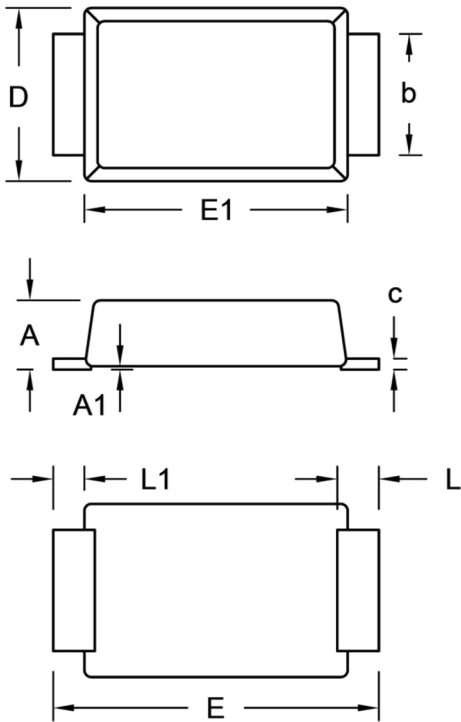


**Fig.9 Typical Transient Thermal Impedance**



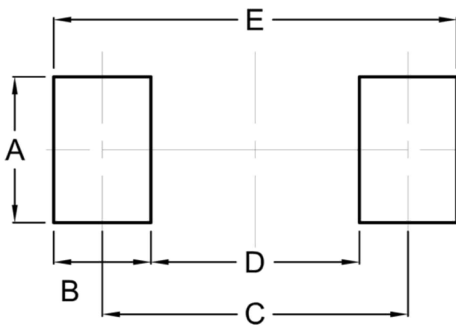
**PACKAGE OUTLINE DIMENSIONS**

SOD-128



DIM.	Unit (mm)		Unit (inch)	
	Min.	Max.	Min.	Max.
A	0.90	1.10	0.035	0.043
A1	0.00	0.10	0.000	0.004
b	1.60	1.90	0.063	0.075
c	0.10	0.22	0.004	0.009
D	2.30	2.70	0.091	0.106
E	4.40	5.00	0.173	0.197
E1	3.60	4.00	0.142	0.157
L	0.40	0.80	0.016	0.031
L1	0.30	0.60	0.012	0.024

**SUGGESTED PAD LAYOUT**



Symbol	Unit (mm)	Unit (inch)
A	2.10	0.083
B	1.40	0.055
C	4.40	0.173
D	3.00	0.118
E	5.80	0.228

**MARKING DIAGRAM**



P/N = Marking Code  
 YW = Date Code  
 F = Factory Code

## Notice

Specifications of the products displayed herein are subject to change without notice. TSC or anyone on its behalf, assumes no responsibility or liability for any errors or inaccuracies.

Purchasers are solely responsible for the choice, selection, and use of TSC products and TSC assumes no liability for application assistance or the design of Purchasers' products.

Information contained herein is intended to provide a product description only. No license, express or implied, to any intellectual property rights is granted by this document. Except as provided in TSC's terms and conditions of sale for such products, TSC assumes no liability whatsoever, and disclaims any express or implied warranty, relating to sale and/or use of TSC products including liability or warranties relating to fitness for a particular purpose, merchantability, or infringement of any patent, copyright, or other intellectual property right.

The products shown herein are not designed for use in medical, life-saving, or life-sustaining applications. Customers using or selling these products for use in such applications do so at their own risk and agree to fully indemnify TSC for any damages resulting from such improper use or sale.

# Mouser Electronics

Authorized Distributor

Click to View Pricing, Inventory, Delivery & Lifecycle Information:

[Taiwan Semiconductor:](#)

[ES1GFS M3G](#) [ES1JFS M3G](#) [ES1BFS M3G](#) [ES1DFS M3G](#)