

## 1A, 100V - 600V Super Fast Surface Mount Rectifier

### FEATURES

- AEC-Q101 qualified
- Glass passivated chip junction
- Ideal for automated placement
- Low power loss, high efficiency
- Low profile package
- Moisture sensitivity level: level 1, per J-STD-020
- RoHS Compliant
- Halogen-free according to IEC 61249-2-21

### APPLICATIONS

- Freewheeling
- Snubber
- DC/DC converters
- Automotive application

### MECHANICAL DATA

- Case: SOD-128
- Molding compound meets UL 94V-0 flammability rating
- Terminal: Matte tin plated leads, solderable per J-STD-002
- Meet JESD 201 class 2 whisker test
- Polarity: Indicated by cathode band
- Weight: 0.028g (approximately)

KEY PARAMETERS		
PARAMETER	VALUE	UNIT
$I_F$	1	A
$V_{RRM}$	100 - 600	V
$I_{FSM}$	30	A
$T_{J\ MAX}$	150	°C
Package	SOD-128	
Configuration	Single die	


**SOD-128**


ABSOLUTE MAXIMUM RATINGS ( $T_A = 25^\circ\text{C}$ unless otherwise noted)						
PARAMETER	SYMBOL	ES1BFSH	ES1DFSH	ES1GFSH	ES1JFSH	UNIT
Marking code on the device		ES1BFH	ES1DFH	ES1GFH	ES1JFH	
Repetitive peak reverse voltage	$V_{RRM}$	100	200	400	600	V
Reverse voltage, total rms value	$V_{R(RMS)}$	70	140	280	420	V
Forward current	$I_F$	1				A
Surge peak forward current, single half sine-wave superimposed on rated load	$t = 8.3\text{ms}$	30				A
	$t = 1.0\text{ms}$					60
Junction temperature	$T_J$	-55 to +150				°C
Storage temperature	$T_{STG}$	-55 to +150				°C

THERMAL PERFORMANCE			
PARAMETER	SYMBOL	TYP	UNIT
Junction-to-lead thermal resistance	$R_{\theta JL}$	28	°C/W
Junction-to-ambient thermal resistance	$R_{\theta JA}$	67	°C/W
Junction-to-case thermal resistance	$R_{\theta JC}$	20	°C/W

**Thermal Performance Note:** Units mounted on PCB (5mm x 5mm Cu pad test board)

ELECTRICAL SPECIFICATIONS ( $T_A = 25^\circ\text{C}$ unless otherwise noted)						
PARAMETER		CONDITIONS	SYMBOL	TYP	MAX	UNIT
Forward voltage <sup>(1)</sup>	ES1BFSH ES1DFSH	$I_F = 0.5\text{A}, T_J = 25^\circ\text{C}$	$V_F$	0.80	-	V
		$I_F = 1.0\text{A}, T_J = 25^\circ\text{C}$		0.85	0.95	V
		$I_F = 0.5\text{A}, T_J = 125^\circ\text{C}$		0.58	-	V
		$I_F = 1.0\text{A}, T_J = 125^\circ\text{C}$		0.71	0.81	V
	ES1GFSH	$I_F = 0.5\text{A}, T_J = 25^\circ\text{C}$		0.86	-	V
		$I_F = 1.0\text{A}, T_J = 25^\circ\text{C}$		0.93	1.30	V
		$I_F = 0.5\text{A}, T_J = 125^\circ\text{C}$		0.69	-	V
		$I_F = 1.0\text{A}, T_J = 125^\circ\text{C}$		0.77	0.89	V
	ES1JFSH	$I_F = 0.5\text{A}, T_J = 25^\circ\text{C}$		1.04	-	V
		$I_F = 1.0\text{A}, T_J = 25^\circ\text{C}$		1.15	1.70	V
		$I_F = 0.5\text{A}, T_J = 125^\circ\text{C}$		0.80	-	V
		$I_F = 1.0\text{A}, T_J = 125^\circ\text{C}$		0.93	1.06	V
Reverse current @ rated $V_R$ <sup>(2)</sup>	$T_J = 25^\circ\text{C}$		$I_R$	-	1	$\mu\text{A}$
	$T_J = 125^\circ\text{C}$			-	20	$\mu\text{A}$
Reverse recovery time		$I_F = 0.5\text{A}, I_R = 1.0\text{A}, I_{rr} = 0.25\text{A}$	$t_{rr}$	-	35	ns
Junction capacitance	ES1BFSH ES1DFSH	1MHz, $V_R = 4.0\text{V}$	$C_J$	18	-	pF
	ES1GFSH			16	-	pF
	ES1JFSH			15	-	pF

**Notes:**

- (1) Pulse test with PW = 0.3ms
- (2) Pulse test with PW = 30ms

ORDERING INFORMATION		
ORDERING CODE <sup>(1)</sup>	PACKAGE	PACKING
ES1xFSH	SOD-128	14,000 / Tape & Reel

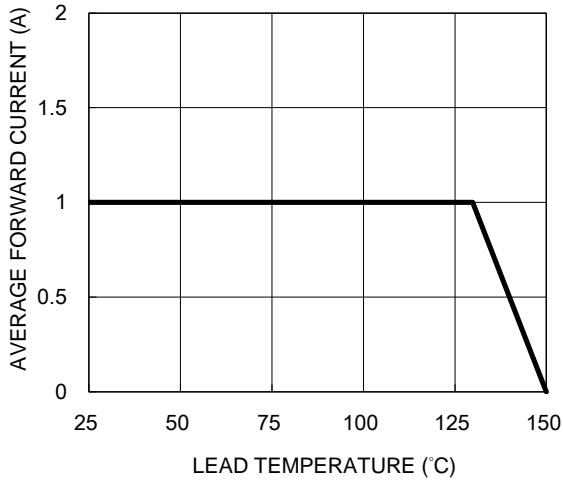
**Notes:**

- (1) "x" defines voltage from 100V(ES1BFSH) to 600V(ES1JFSH)

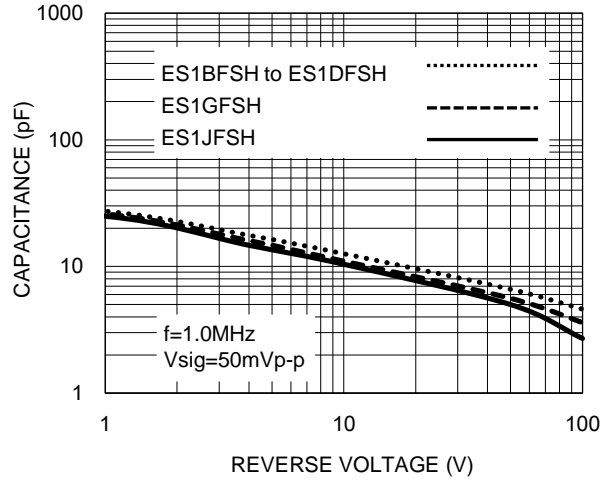
**CHARACTERISTICS CURVES**

( $T_A = 25^\circ\text{C}$  unless otherwise noted)

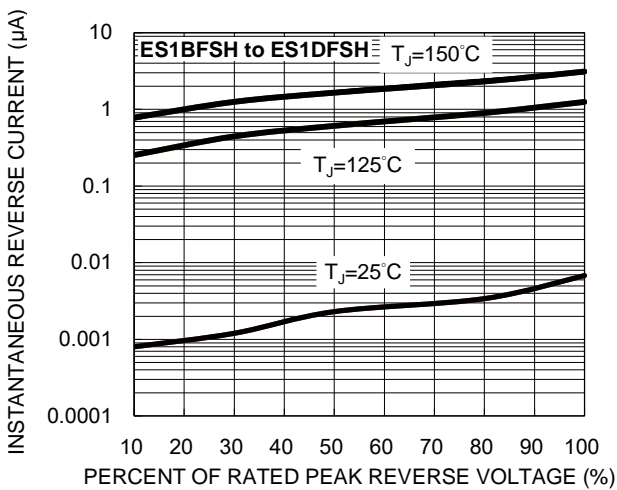
**Fig.1 Forward Current Derating Curve**



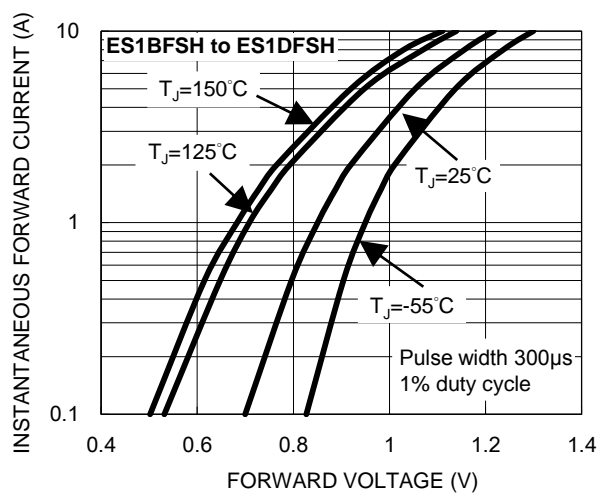
**Fig.2 Typical Junction Capacitance**



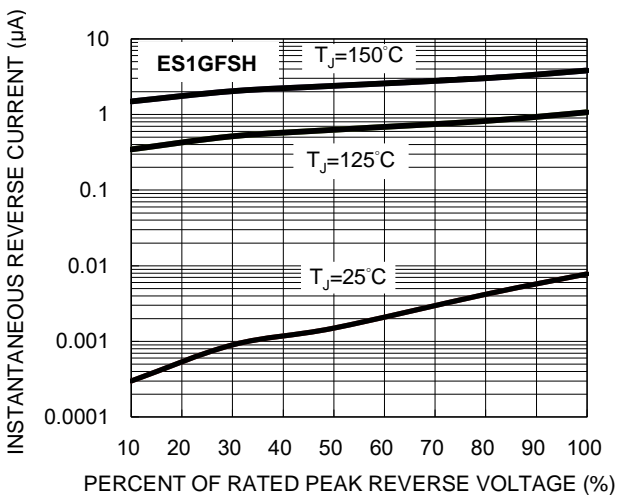
**Fig.3 Typical Reverse Characteristics**



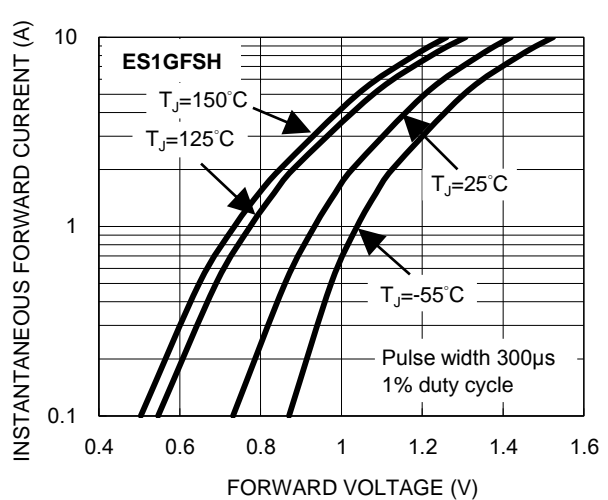
**Fig.4 Typical Forward Characteristics**



**Fig.5 Typical Reverse Characteristics**



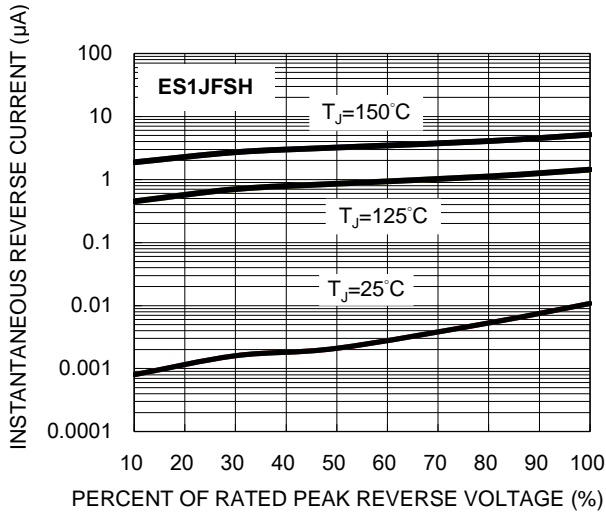
**Fig.6 Typical Forward Characteristics**



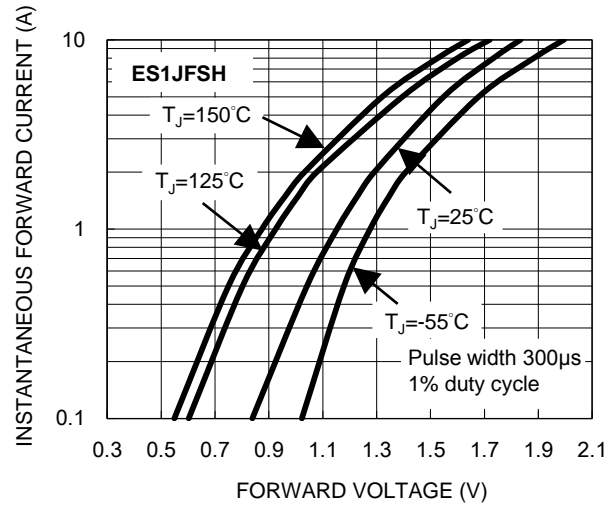
**CHARACTERISTICS CURVES**

( $T_A = 25^\circ\text{C}$  unless otherwise noted)

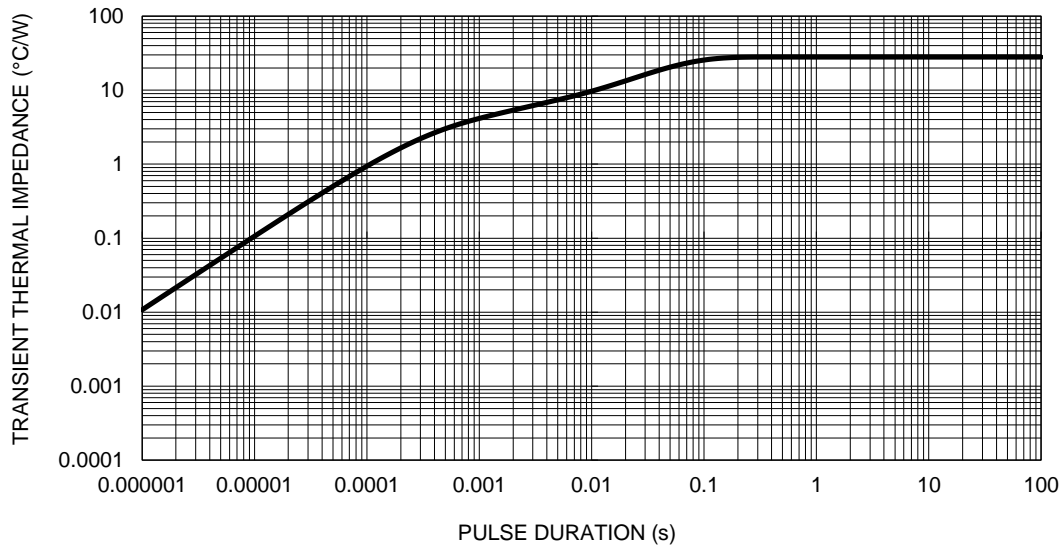
**Fig.7 Typical Reverse Characteristics**



**Fig.8 Typical Forward Characteristics**

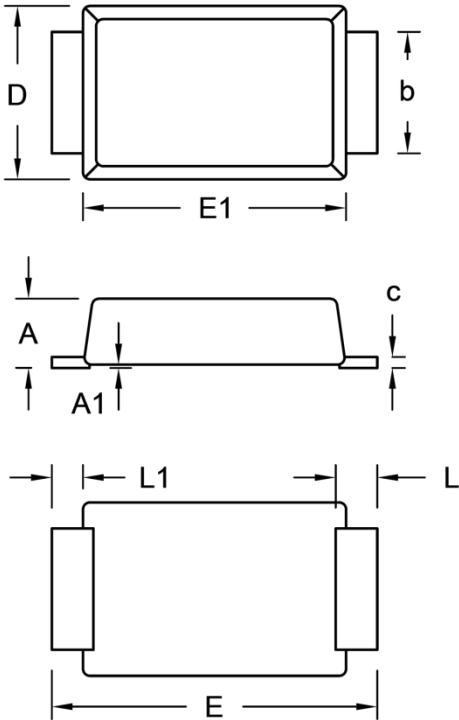


**Fig.9 Typical Transient Thermal Impedance**



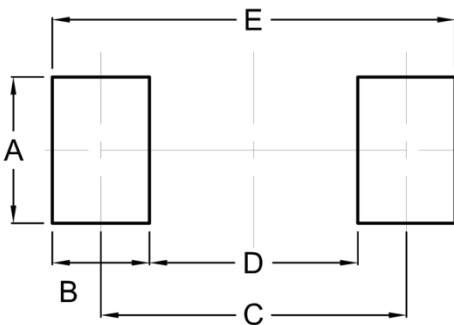
**PACKAGE OUTLINE DIMENSIONS**

SOD-128



DIM.	Unit (mm)		Unit (inch)	
	Min.	Max.	Min.	Max.
A	0.90	1.10	0.035	0.043
A1	0.00	0.10	0.000	0.004
b	1.60	1.90	0.063	0.075
c	0.10	0.22	0.004	0.009
D	2.30	2.70	0.091	0.106
E	4.40	5.00	0.173	0.197
E1	3.60	4.00	0.142	0.157
L	0.40	0.80	0.016	0.031
L1	0.30	0.60	0.012	0.024

**SUGGESTED PAD LAYOUT**



Symbol	Unit (mm)	Unit (inch)
A	2.10	0.083
B	1.40	0.055
C	4.40	0.173
D	3.00	0.118
E	5.80	0.228

**MARKING DIAGRAM**



P/N = Marking Code  
 YW = Date Code  
 F = Factory Code

## Notice

Specifications of the products displayed herein are subject to change without notice. TSC or anyone on its behalf, assumes no responsibility or liability for any errors or inaccuracies.

Purchasers are solely responsible for the choice, selection, and use of TSC products and TSC assumes no liability for application assistance or the design of Purchasers' products.

Information contained herein is intended to provide a product description only. No license, express or implied, to any intellectual property rights is granted by this document. Except as provided in TSC's terms and conditions of sale for such products, TSC assumes no liability whatsoever, and disclaims any express or implied warranty, relating to sale and/or use of TSC products including liability or warranties relating to fitness for a particular purpose, merchantability, or infringement of any patent, copyright, or other intellectual property right.

The products shown herein are not designed for use in medical, life-saving, or life-sustaining applications. Customers using or selling these products for use in such applications do so at their own risk and agree to fully indemnify TSC for any damages resulting from such improper use or sale.

# Mouser Electronics

Authorized Distributor

Click to View Pricing, Inventory, Delivery & Lifecycle Information:

[Taiwan Semiconductor:](#)

[ES1BFSH](#) [ES1DFSH](#) [ES1GFSH](#) [ES1JFSH](#)