

## Glass Passivated Fast Recovery Rectifiers

### FEATURES

- Glass passivated chip junction
- High current capability, Low VF
- High reliability
- High surge current capability
- Low power loss, high efficiency
- Compliant to RoHS Directive 2011/65/EU and in accordance to WEEE 2002/96/EC
- Halogen-free according to IEC 61249-2-21 definition

### MECHANICAL DATA

**Case:** DO-204AL (DO-41)

Molding compound, UL flammability classification rating 94V-0

Base P/N with suffix "G" on packing code - green compound (halogen-free)

Base P/N with prefix "H" on packing code - AEC-Q101 qualified

**Terminal:** Matte tin plated leads, solderable per JESD22-B102

Meet JESD 201 class 1A whisker test

with prefix "H" on packing code meet JESD 201 class 2 whisker test

**Weight:** 0.33 g (approximately)

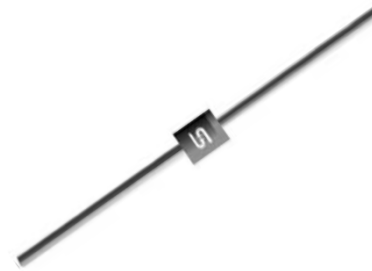

**DO-204AL (DO-41)**



MAXIMUM RATINGS AND ELECTRICAL CHARACTERISTICS (T <sub>A</sub> =25°C unless otherwise noted)					
PARAMETER	SYMBOL	BA157G	BA158G	BA159G	UNIT
Maximum repetitive peak reverse voltage	V <sub>RRM</sub>	400	600	1000	V
Maximum RMS voltage	V <sub>RMS</sub>	280	420	700	V
Maximum DC blocking voltage	V <sub>DC</sub>	400	600	1000	V
Maximum average forward rectified current	I <sub>F(AV)</sub>	1			A
Peak forward surge current, 8.3 ms single half sine-wave superimposed on rated load	I <sub>FSM</sub>	30			A
Maximum instantaneous forward voltage (Note 1) @ 1 A	V <sub>F</sub>	1.2			V
Maximum reverse current @ rated VR T <sub>J</sub> =25 °C T <sub>J</sub> =125 °C	I <sub>R</sub>	5 100			μA
Maximum reverse recovery time (Note 2)	T <sub>rr</sub>	150	250		ns
Typical junction capacitance (Note 3)	C <sub>j</sub>	15			pF
Typical thermal resistance	R <sub>θJA</sub>	60			°C/W
Operating junction temperature range	T <sub>J</sub>	- 55 to +150			°C
Storage temperature range	T <sub>STG</sub>	- 55 to +150			°C

Note 1: Pulse Test with PW=300μs, 1% Duty Cycle

Note 2: Reverse Recovery Test Conditions: I<sub>F</sub>=0.5A, I<sub>R</sub>=1.0A, I<sub>RR</sub>=0.25A

Note 3: Measured at 1 MHz and Applied Reverse Voltage of 4.0V D.C.

ORDERING INFORMATION					
PART NO.	AEC-Q101 QUALIFIED	PACKING CODE	GREEN COMPOUND CODE	PACKAGE	PACKING
BA15xG (Note 1)	Prefix "H"	A0	Suffix "G"	DO-41	3,000 / Ammo box (52mm taping)
		R0		DO-41	5,000 / 13" Paper reel
		R1		DO-41	5,000 / 13" Paper reel (Reverse)
		B0		DO-41	1,000 / Bulk packing

Note 1: "x" defines voltage from 400V (BA157G) to 1000V (BA159G)

EXAMPLE					
PREFERRED P/N	PART NO.	AEC-Q101 QUALIFIED	PACKING CODE	GREEN COMPOUND CODE	DESCRIPTION
BA157G A0	BA157G		A0		
BA157G A0G	BA157G		A0	G	Green compound
BA157GHA0	BA157G	H	A0		AEC-Q101 qualified

**RATINGS AND CHARACTERISTICS CURVES**

(TA=25°C unless otherwise noted)

FIG. 1- MAXIMUM FORWARD CURRENT DERATING CURVE

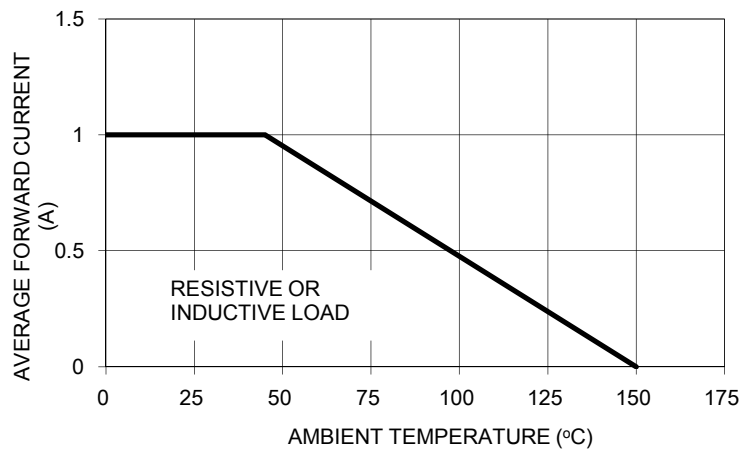

FIG. 2- TYPICAL REVERSE CHARACTERISTICS

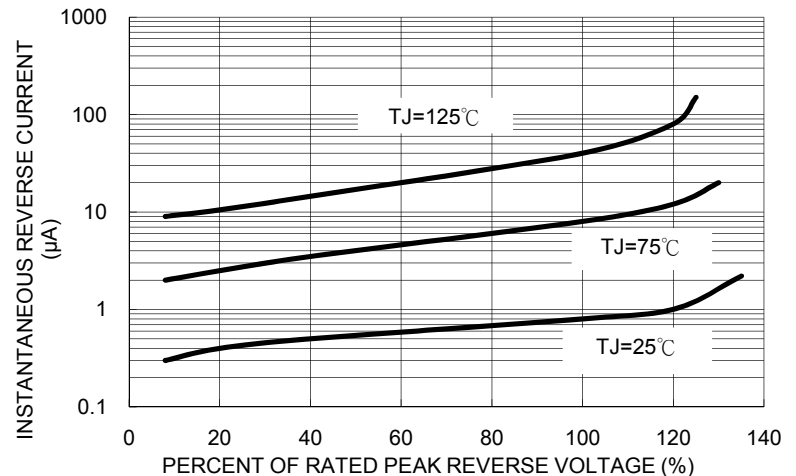

FIG. 3- MAXIMUM NON-REPETITIVE FORWARD SURGE CURRENT

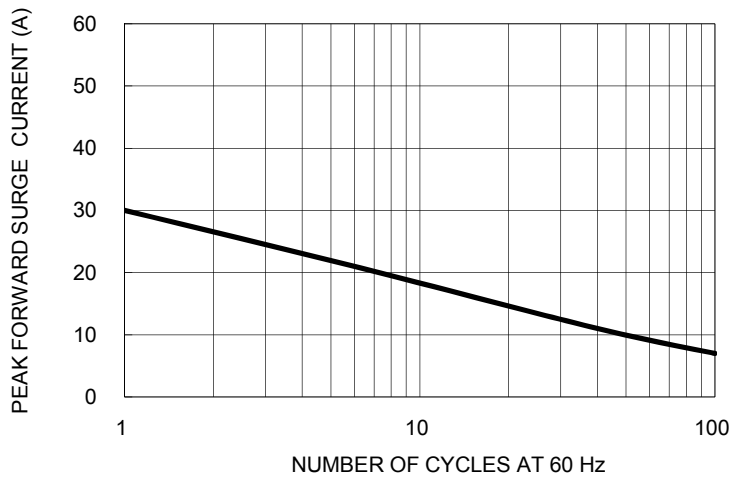

FIG. 4- TYPICAL FORWARD CHARACTERISTICS

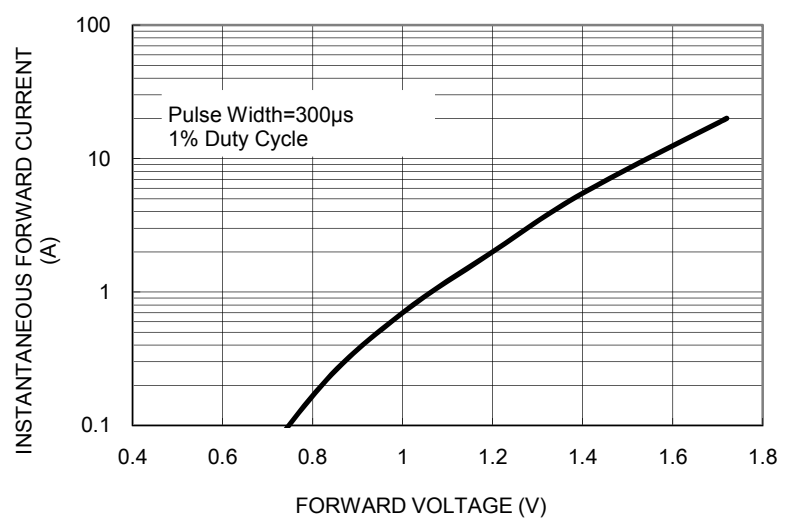

FIG. 5- TYPICAL JUNCTION CAPACITANCE

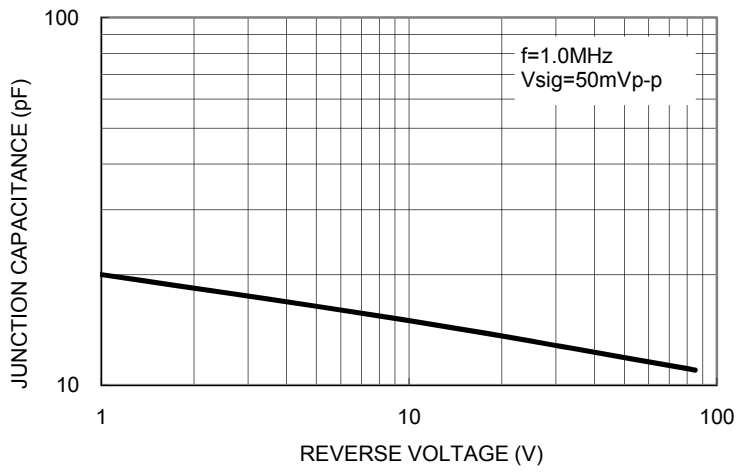
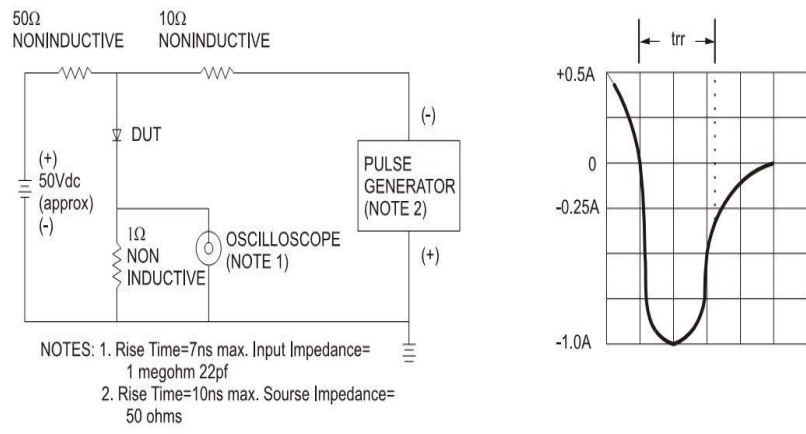
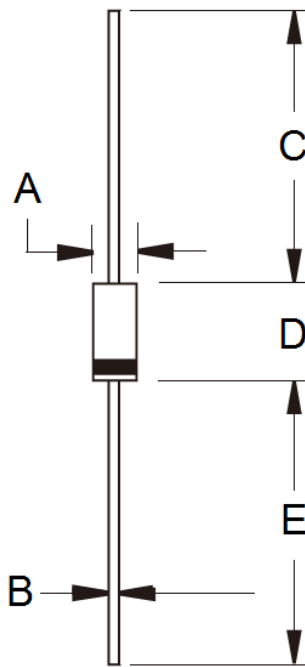

FIG.6- REVERSE RECOVERY TIME CHARACTERISTIC AND TEST CIRCUIT DIAGRAM



PACKAGE OUTLINE DIMENSIONS



DIM.	Unit (mm)		Unit (inch)	
	Min	Max	Min	Max
A	2.00	2.70	0.079	0.106
B	0.71	0.86	0.028	0.034
C	25.40	-	1.000	-
D	4.20	5.20	0.165	0.205
E	25.40	-	1.000	-

MARKING DIAGRAM



P/N = Specific Device Code  
G = Green Compound  
YWW = Date Code  
F = Factory Code

## Notice

Specifications of the products displayed herein are subject to change without notice. TSC or anyone on its behalf, assumes no responsibility or liability for any errors inaccuracies.

Information contained herein is intended to provide a product description only. No license, express or implied, to any intellectual property rights is granted by this document. Except as provided in TSC's terms and conditions of sale for such products, TSC assumes no liability whatsoever, and disclaims any express or implied warranty, relating to sale and/or use of TSC products including liability or warranties relating to fitness for a particular purpose, merchantability, or infringement of any patent, copyright, or other intellectual property right.

The products shown herein are not designed for use in medical, life-saving, or life-sustaining applications. Customers using or selling these products for use in such applications do so at their own risk and agree to fully indemnify TSC for any damages resulting from such improper use or sale.

# Mouser Electronics

Authorized Distributor

Click to View Pricing, Inventory, Delivery & Lifecycle Information:

## Taiwan Semiconductor:

[BA157G](#) [BA158G](#) [BA159G](#) [BA158G R0G](#) [BA159GHR0](#) [BA157GHR0G](#) [BA159G R0G](#) [BA158GHR0G](#)  
[BA159GHR0G](#) [BA157G R0G](#) [BA158G R0](#) [BA157G R0](#) [BA159G R0](#) [BA158G B0G](#) [BA157GHA1G](#) [BA157G B0G](#)  
[BA158GHB0G](#) [BA157G A0G](#) [BA159G A1G](#) [BA157G A1G](#) [BA158GHA0G](#) [BA158GHA1G](#) [BA159GHB0G](#)  
[BA157GHB0G](#) [BA158G A1G](#) [BA159G A0G](#) [BA159G B0G](#) [BA159G R1G](#) [BA159GHR1G](#) [BA159GHA0G](#)  
[BA159GHA1G](#) [BA157GH](#) [BA158GH](#) [BA159GH](#)