

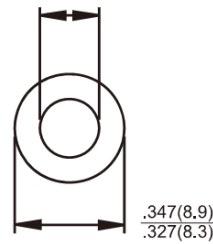

ARS50 SERIES 50 AMPS. High Current Button Rectifiers

ARS

.225(5.7)
.215(5.5)



.347(8.9)
.327(8.3)

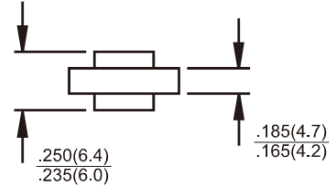

Dimensions in inches and (millimeters)

Marking Diagram

ARS50X = Specific Device Code

G = Green Compound

Y = Year

M = Work Month



Features

- ✧ Plastic material used carries Underwriters Laboratory Classification 94V-0
- ✧ Low cost construction utilizing void-free molded plastic technique
- ✧ Low cost
- ✧ Diffused junction
- ✧ Low leakage
- ✧ High surge capability
- ✧ High temperature soldering guaranteed: 260°C for 10 seconds
- ✧ Green compound with suffix "G" on packing code & prefix "G" on datecode

Mechanical Data

- ✧ Case: Molded plastic case
- ✧ Terminals: Pure tin plated, lead free, solderable per MIL-STD-202, Method 208
- ✧ Polarity: Color ring denotes cathode
- ✧ Weight: 1.8 grams
- ✧ Mounting position: Any

Maximum Ratings and Electrical Characteristics

Rating at 25 °C ambient temperature unless otherwise specified.

Single phase, half wave, 60 Hz, resistive or inductive load.

For capacitive load, derate current by 20%

Type Number	Symbol	ARS 50A	ARS 50B	ARS 50D	ARS 50G	ARS 50J	ARS 50K	ARS 50M	Units
Maximum Recurrent Peak Reverse Voltage	V_{RRM}	50	100	200	400	600	800	1000	V
Maximum RMS Voltage	V_{RMS}	35	70	140	280	420	560	700	V
Maximum DC Blocking Voltage	V_{DC}	50	100	200	400	600	800	1000	V
Maximum Average Forward Rectified Current @ $T_C=135^\circ C$	$I_{F(AV)}$	50							A
Peak Forward Surge Current, 8.3 ms Single Half Sine-wave Superimposed on Rated Load (JEDEC method) at $T_J=150^\circ C$	I_{FSM}	500							A
Maximum Instantaneous Forward Voltage (Note 1) @ 50A	V_F	1.1							V
Maximum DC Reverse Current at @ $T_A=25^\circ C$ Rated DC Blocking Voltage @ $T_A=125^\circ C$	I_R	5 250							μA μA
Typical Reverse Recovery Time (Note 2)	T_{rr}	3.0							μS
Typical Junction Capacitance (Note 3)	C_j	300							pF
Typical Thermal Resistance (Note 4)	$R_{\theta JC}$	1.0							$^\circ C/W$
Operating and Storage Temperature Range	T_J, T_{STG}	- 50 to + 175							$^\circ C$

Note 1: Pulse Test with PW=300 usec, 1% Duty Cycle

Note 2: Reverse Recovery Time Test Conditions: $I_F=0.5A$, $I_R=1.0A$, $I_{RR}=0.25A$

Note 3: Measured at 1 MHz and Applied Reverse Voltage of 4.0V D.C.

Note 4: Thermal Resistance from Junction to Case, Single Side Cooled.

RATINGS AND CHARACTERISTIC CURVES (ARS50 SERIES)

FIG.1- MAXIMUM FORWARD CURRENT DERATING CURVE

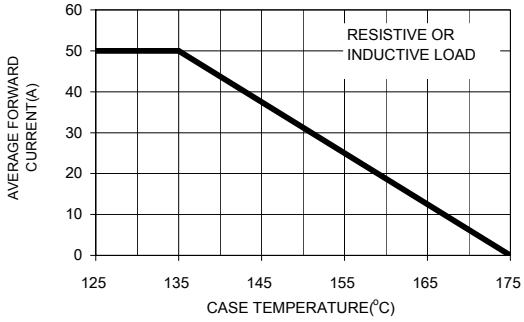

FIG. 2- TYPICAL REVERSE CHARACTERISTICS

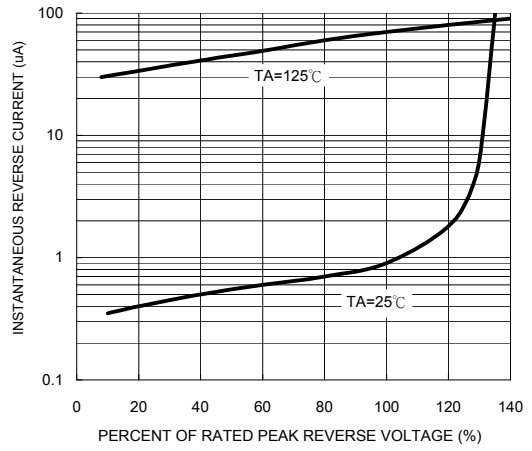

FIG. 3- MAXIMUM NON-REPETITIVE PEAK FORWARD SURGE CURRENT

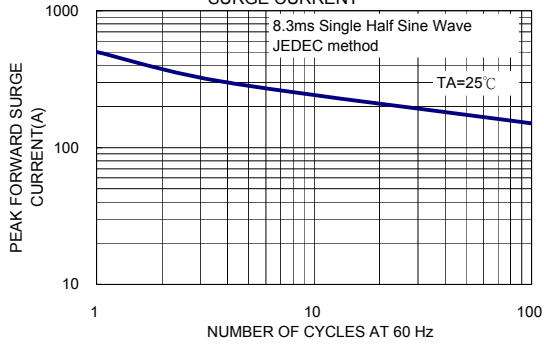

FIG. 5- TYPICAL FORWARD CHARACTERISTICS

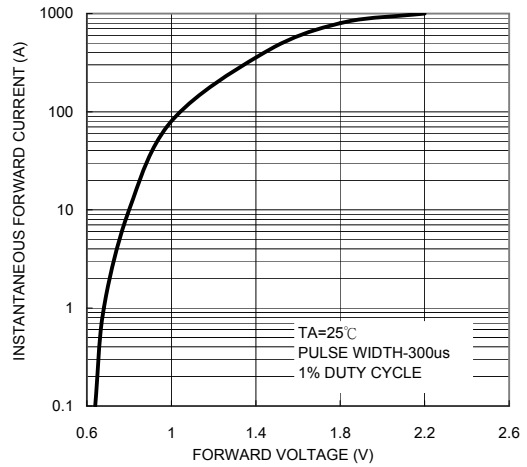

FIG. 4- TYPICAL JUNCTION CAPACITANCE

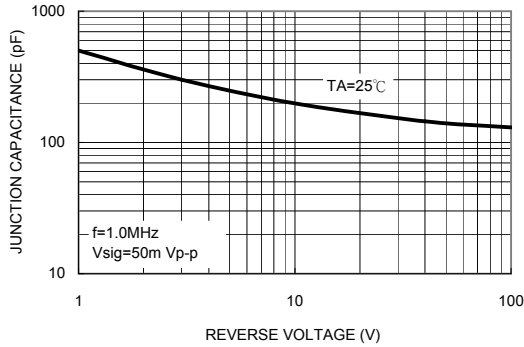
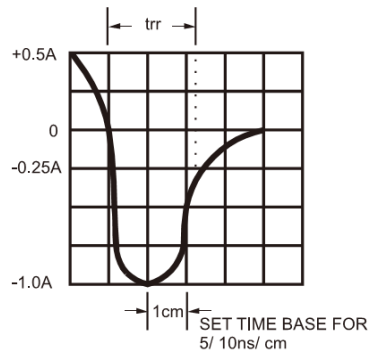
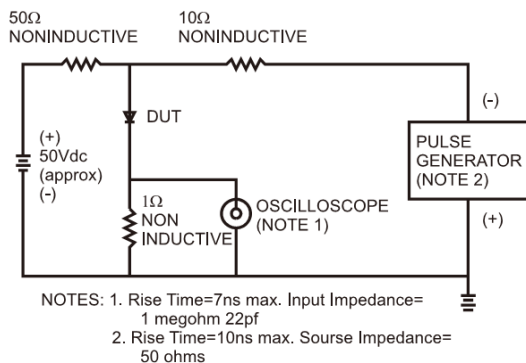

FIG.6- REVERSE RECOVERY TIME CHARACTERISTIC AND TEST CIRCUIT DIAGRAM



Mouser Electronics

Authorized Distributor

Click to View Pricing, Inventory, Delivery & Lifecycle Information:

[Taiwan Semiconductor:](#)

[ARS50A](#) [ARS50B](#) [ARS50D](#) [ARS50G](#) [ARS50J](#) [ARS50K](#) [ARS50M](#)