

Glass Passivated Rectifiers

FEATURES

- Glass passivated chip junction
- High current capability, Low VF
- High reliability
- High surge current capability
- Low power loss
- Compliant to RoHS Directive 2011/65/EU and in accordance to WEEE 2002/96/EC
- Halogen-free according to IEC 61249-2-21 definition

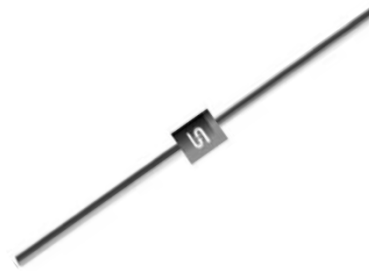

R-6



MECHANICAL DATA

Case: R-6

Molding compound, UL flammability classification rating 94V-0

Base P/N with suffix "G" on packing code - green compound (halogen-free)

Base P/N with prefix "H" on packing code - AEC-Q101 qualified

Terminal: Matte tin plated leads, solderable per JESD22-B102

Meet JESD 201 class 1A whisker test

with prefix "H" on packing code meet JESD 201 class 2 whisker test

Weight: 1.65 g (approximately)

MAXIMUM RATINGS AND ELECTRICAL CHARACTERISTICS (T _A =25°C unless otherwise noted)									
PARAMETER	SYMBOL	6A 05G	6A 10G	6A 20G	6A 40G	6A 60G	6A 80G	6A 100G	UNIT
Maximum repetitive peak reverse voltage	V _{RRM}	50	100	200	400	600	800	1000	V
Maximum RMS voltage	V _{RMS}	35	70	140	280	420	560	700	V
Maximum DC blocking voltage	V _{DC}	50	100	200	400	600	800	1000	V
Maximum average forward rectified current	I _{F(AV)}	6							A
Peak forward surge current, 8.3 ms single half sine-wave superimposed on rated load	I _{FSM}	250							A
Maximum instantaneous forward voltage (Note 1) @ 6 A	V _F	1.1	1.0					V	
Maximum reverse current @ rated VR	I _R	10 100							μA
Typical junction capacitance (Note 2)	C _j	60							pF
Typical thermal resistance	R _{θJA}	35							°C/W
Operating junction temperature range	T _J	- 55 to +150							°C
Storage temperature range	T _{STG}	- 55 to +150							°C

Note 1: Pulse Test with PW=300μs, 1% Duty Cycle

Note 2: Measured at 1 MHz and Applied Reverse Voltage of 4.0V D.C.

ORDERING INFORMATION					
PART NO.	AEC-Q101 QUALIFIED	PACKING CODE	GREEN COMPOUND CODE	PACKAGE	PACKING
6A0xG (Note 1)	Prefix "H"	A0	Suffix "G"	R-6	700 / Ammo box
		R0		R-6	1,000 / 13" Paper reel
		B0		R-6	400 / Bulk packing

Note 1: "x" defines voltage from 50V (6A05G) to 1000V (6A100G)

EXAMPLE					
PREFERRED P/N	PART NO.	AEC-Q101 QUALIFIED	PACKING CODE	GREEN COMPOUND CODE	DESCRIPTION
6A05G A0	6A05G		A0		
6A05G A0G	6A05G		A0	G	Green compound
6A05GHA0	6A05G	H	A0		AEC-Q101 qualified

RATINGS AND CHARACTERISTICS CURVES

(TA=25°C unless otherwise noted)

FIG.1- MAXIMUM FORWARD CURRENT DERATING CURVE

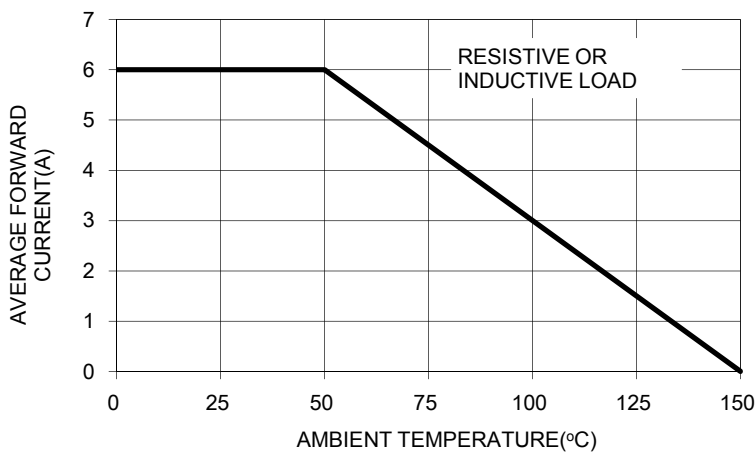

FIG. 2- TYPICAL REVERSE CHARACTERISTICS

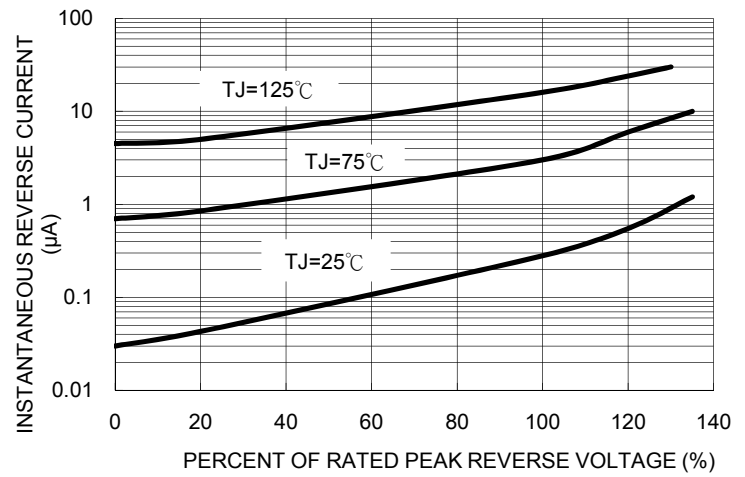

FIG. 3- MAXIMUM NON-REPETITIVE FORWARD SURGE CURRENT

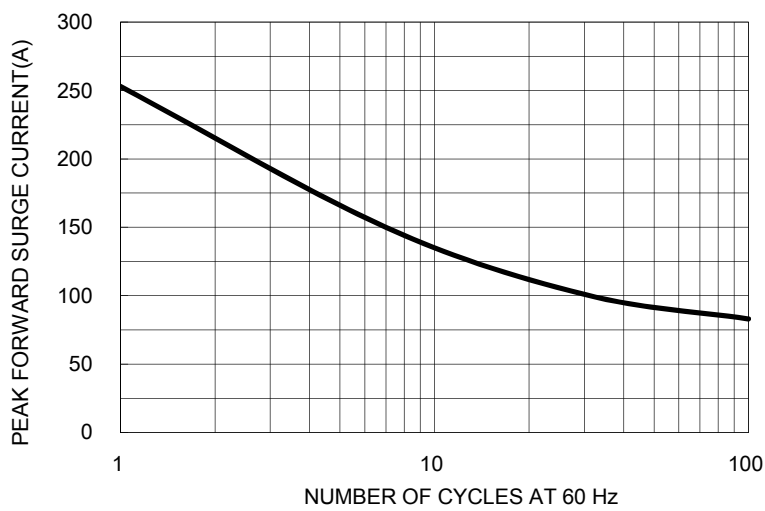

FIG. 4- TYPICAL FORWARD CHARACTERISTICS

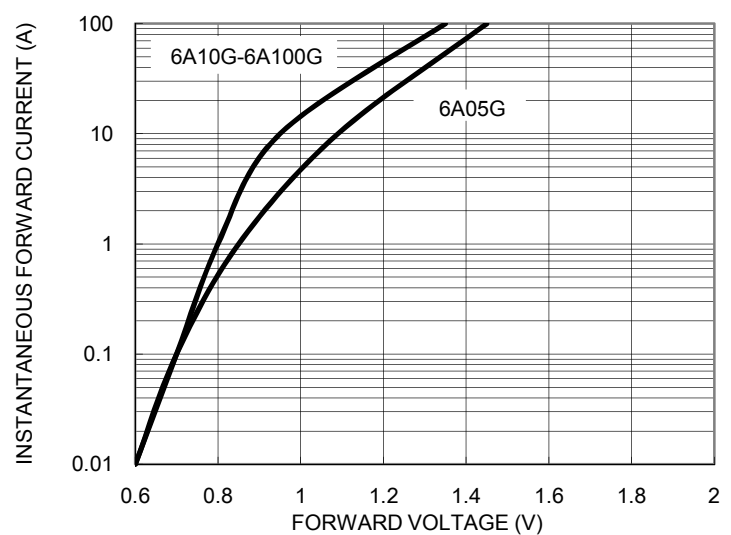
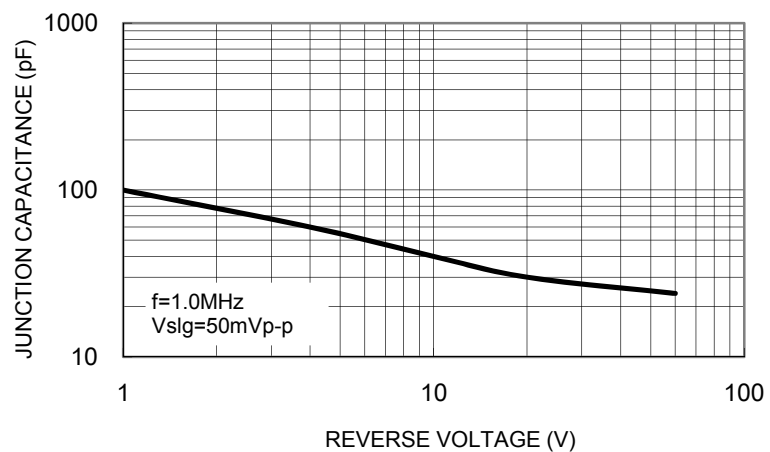
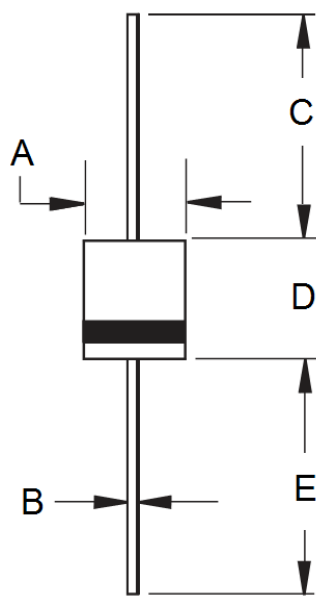

FIG. 5- TYPICAL JUNCTION CAPACITANCE



PACKAGE OUTLINE DIMENSIONS



DIM.	Unit (mm)		Unit (inch)	
	Min	Max	Min	Max
A	6.80	7.20	0.268	0.283
B	1.20	1.30	0.047	0.051
C	25.40	-	1.000	-
D	8.60	9.10	0.339	0.358
E	25.40	-	1.000	-

MARKING DIAGRAM

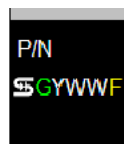

P/N = Specific Device Code
 G = Green Compound
 YWW = Date Code
 F = Factory Code

Notice

Specifications of the products displayed herein are subject to change without notice. TSC or anyone on its behalf, assumes no responsibility or liability for any errors inaccuracies.

Information contained herein is intended to provide a product description only. No license, express or implied, to any intellectual property rights is granted by this document. Except as provided in TSC's terms and conditions of sale for such products, TSC assumes no liability whatsoever, and disclaims any express or implied warranty, relating to sale and/or use of TSC products including liability or warranties relating to fitness for a particular purpose, merchantability, or infringement of any patent, copyright, or other intellectual property right.

The products shown herein are not designed for use in medical, life-saving, or life-sustaining applications. Customers using or selling these products for use in such applications do so at their own risk and agree to fully indemnify TSC for any damages resulting from such improper use or sale.

Mouser Electronics

Authorized Distributor

Click to View Pricing, Inventory, Delivery & Lifecycle Information:

Taiwan Semiconductor:

[6A05G](#) [6A100G](#) [6A10G](#) [6A20G](#) [6A40G](#) [6A60G](#) [6A80G](#) [6A80G R0G](#) [6A40GHR0](#) [6A40GHR0G](#) [6A80GHR0G](#)
[6A100G R0G](#) [6A20GHR0G](#) [6A100GHR0G](#) [6A10GHR0G](#) [6A05GHR0G](#) [6A60GHR0](#) [6A05G R0G](#) [6A40G R0G](#)
[6A10G R0G](#) [6A60GHR0G](#) [6A20G R0G](#) [6A100GHR0](#) [6A60G R0G](#) [6A60G R0](#) [6A05G R0](#) [6A20G R0](#) [6A80G R0](#)
[6A10G R0](#) [6A40G R0](#) [6A60G B0G](#) [6A60G A0G](#) [6A80G A0G](#) [6A40G A0G](#) [6A10G A0G](#) [6A40GHA0G](#) [6A20G B0G](#)
[6A80GHA0G](#) [6A40GHB0G](#) [6A100G A0G](#) [6A20G A0G](#) [6A60GHA0G](#) [6A10G B0G](#) [6A05G A0G](#) [6A100GH](#) [6A40GH](#)
[6A60GH](#) [6A80GH](#)