

# SMD Power Inductor CR32

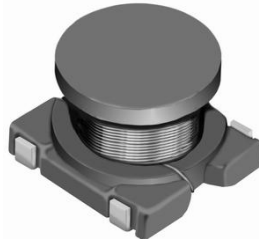

## Description

- Ferrite drum core construction.
- Magnetically unshielded.
- L × W × H: 4.1 × 3.8 × 3.0 mm Max.
- Product weight: 85mg(Ref.)
- Moisture Sensitivity Level: 1
- RoHS compliance.

## Environmental Data

- Operating temperature range: -40°C ~ +100°C (including coil's self temperature rise)
- Storage temperature range: -40°C ~ +100°C
- Solder reflow temperature: 260 °C peak.

## Packaging

- Carrier tape and reel packaging
- 12" diameter reel
- 2000pcs per reel

## Applications

- Ideally used in A/V equipment, LCD TV, DSC/DVC, Game Machine, DVC, HDD, Notebook PC, etc as DC-DC converter inductors.

## Dimension - [mm]

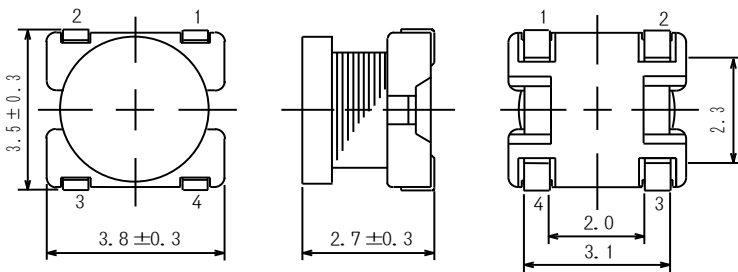

## Land pattern and Schematics - [mm]

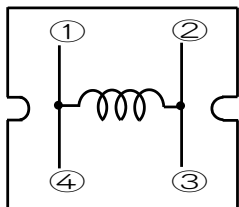
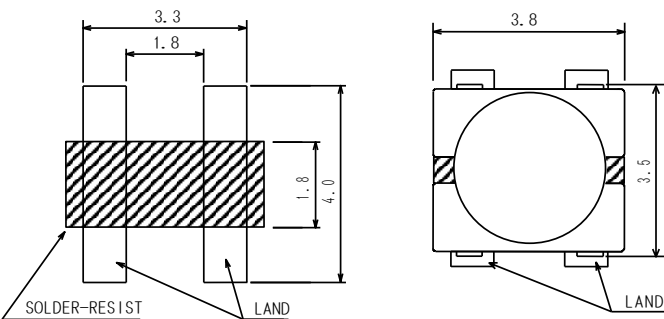



## Electrical Characteristics

Part Name	Stamp	Inductance ( $\mu\text{H}$ ) [ within ] $\times 1$	D.C.R. ( $\text{m}\Omega$ ) [ Max. ] at 20°C	Rated Current (mA) $\times 2$
CR32NP-1R0MC	<u>A</u>	1.0 $\pm$ 20%	72	2100
CR32NP-1R2MC	<u>B</u>	1.2 $\pm$ 20%	78	1700
CR32NP-1R5MC	<u>C</u>	1.5 $\pm$ 20%	85	1500
CR32NP-1R8MC	<u>D</u>	1.8 $\pm$ 20%	91	1320
CR32NP-2R2MC	<u>E</u>	2.2 $\pm$ 20%	104	1280
CR32NP-2R7MC	<u>F</u>	2.7 $\pm$ 20%	111	1240
CR32NP-3R3MC	<u>G</u>	3.3 $\pm$ 20%	137	1180
CR32NP-3R9MC	<u>H</u>	3.9 $\pm$ 20%	143	1150
CR32NP-4R7MC	<u>J</u>	4.7 $\pm$ 20%	170	1040
CR32NP-5R6MC	<u>K</u>	5.6 $\pm$ 20%	176	1000
CR32NP-6R8MC	<u>L</u>	6.8 $\pm$ 20%	202	880
CR32NP-7R4MC	<u>M</u>	7.4 $\pm$ 20%	215	840
CR32NP-8R2MC	<u>N</u>	8.2 $\pm$ 20%	228	780
CR32NP-100KC	A	10 $\pm$ 10%	230	760
CR32NP-120KC	B	12 $\pm$ 10%	270	685
CR32NP-150KC	C	15 $\pm$ 10%	310	635
CR32NP-180KC	D	18 $\pm$ 10%	410	525
CR32NP-220KC	E	22 $\pm$ 10%	470	500
CR32NP-270KC	F	27 $\pm$ 10%	660	405
CR32NP-330KC	G	33 $\pm$ 10%	760	380
CR32NP-390KC	H	39 $\pm$ 10%	850	355
CR32NP-470KC	J	47 $\pm$ 10%	970	330
CR32NP-560KC	K	56 $\pm$ 10%	1250	290
CR32NP-680KC	L	68 $\pm$ 10%	1450	275
CR32NP-820KC	M	82 $\pm$ 10%	1850	235
CR32NP-101KC	N	100 $\pm$ 10%	2200	220
CR32NP-121KC	P	120 $\pm$ 10%	2900	185
CR32NP-151KC	Q	150 $\pm$ 10%	3400	170
CR32NP-181KC	R	180 $\pm$ 10%	3900	165
CR32NP-221KC	S	220 $\pm$ 10%	4500	155
CR32NP-271KC	T	270 $\pm$ 10%	6000	135
CR32NP-331KC	U	330 $\pm$ 10%	7000	125
CR32NP-391KC	V	390 $\pm$ 10%	7800	115

※1. Inductance measuring frequency: 1.0 $\mu\text{H}$  ~ 8.2 $\mu\text{H}$  ; at 7.96 MHz  
10 $\mu\text{H}$  ~ 390 $\mu\text{H}$  ; at 100 kHz

※2. Rated current: The D.C. current at which the inductance decreases to 90% of its initial value or when  $\Delta t=40^\circ\text{C}$ , whichever is lower ( $T_a=20^\circ\text{C}$ ).

# SMD Power Inductor CR32



## Saturation Current & Temperature Rise Graph

— L (20°C) — L (100°C) —  $\Delta T$

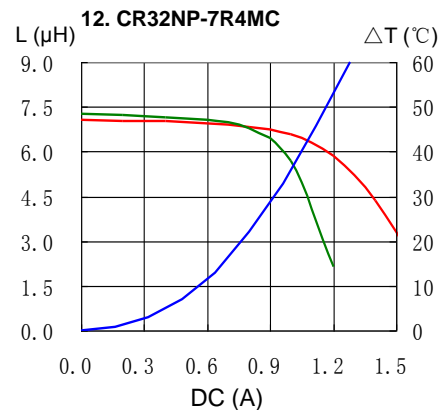
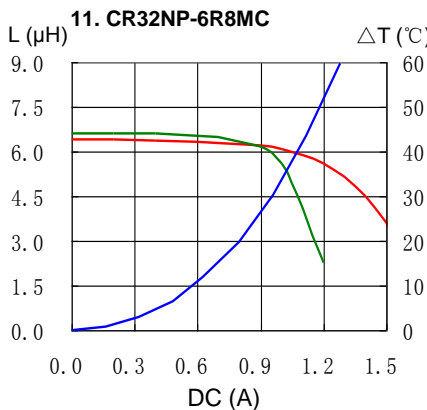
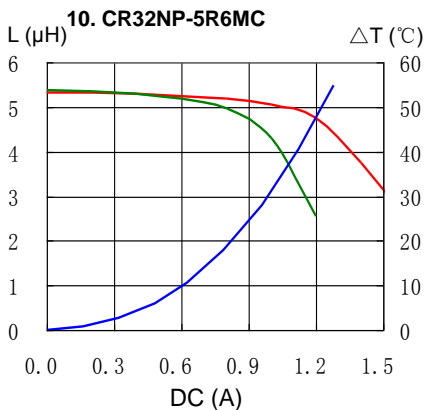
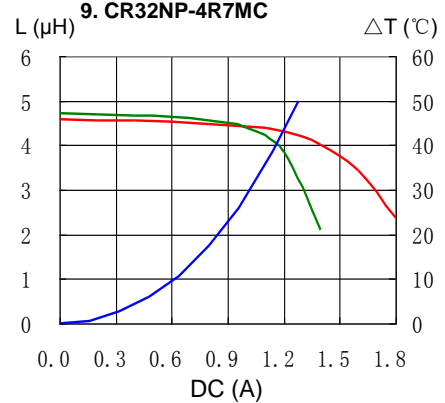
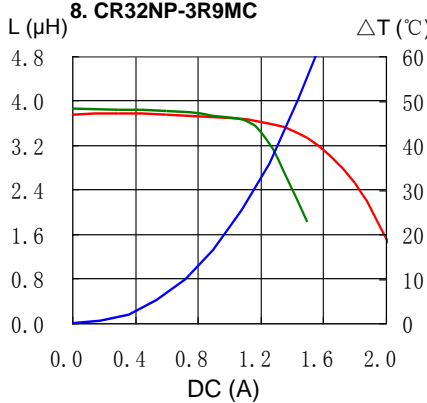
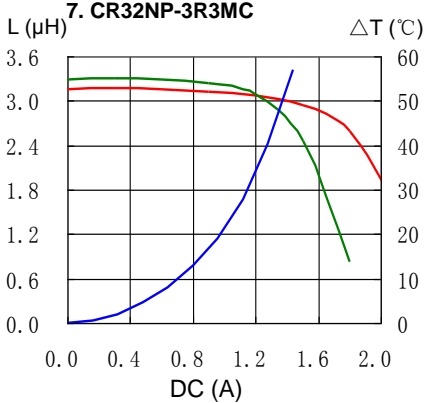
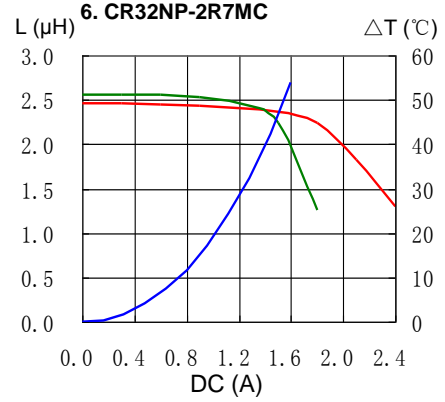
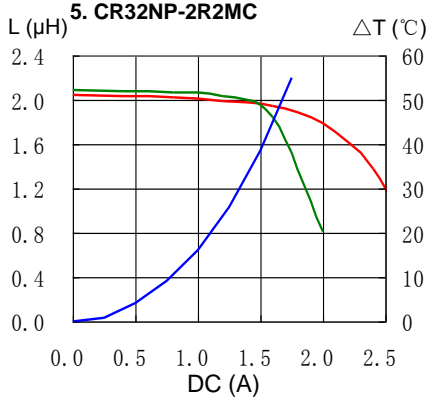
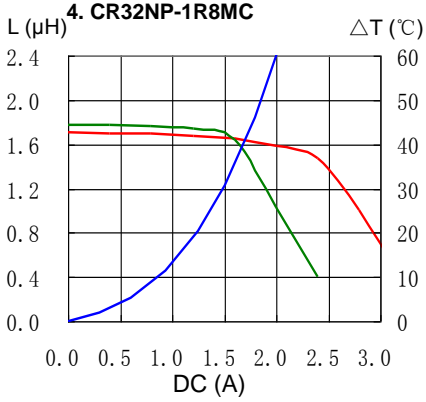
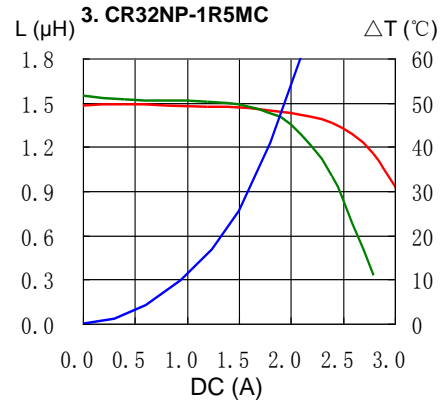
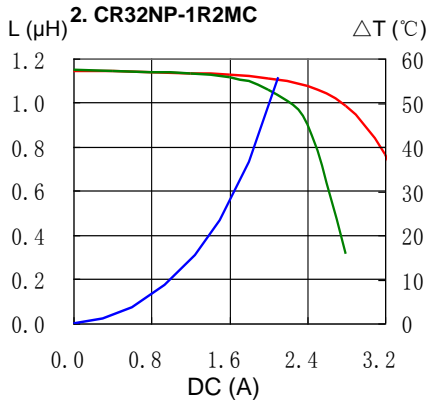
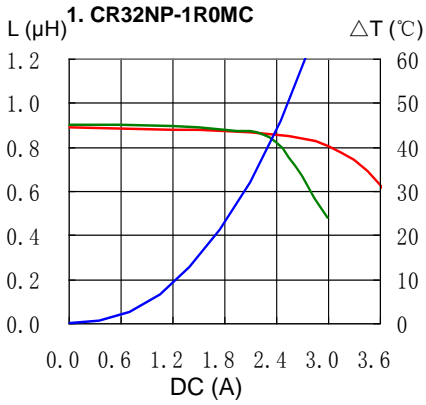



## Saturation Current & Temperature Rise Graph

— L (20°C) — L (100°C) —  $\Delta T$

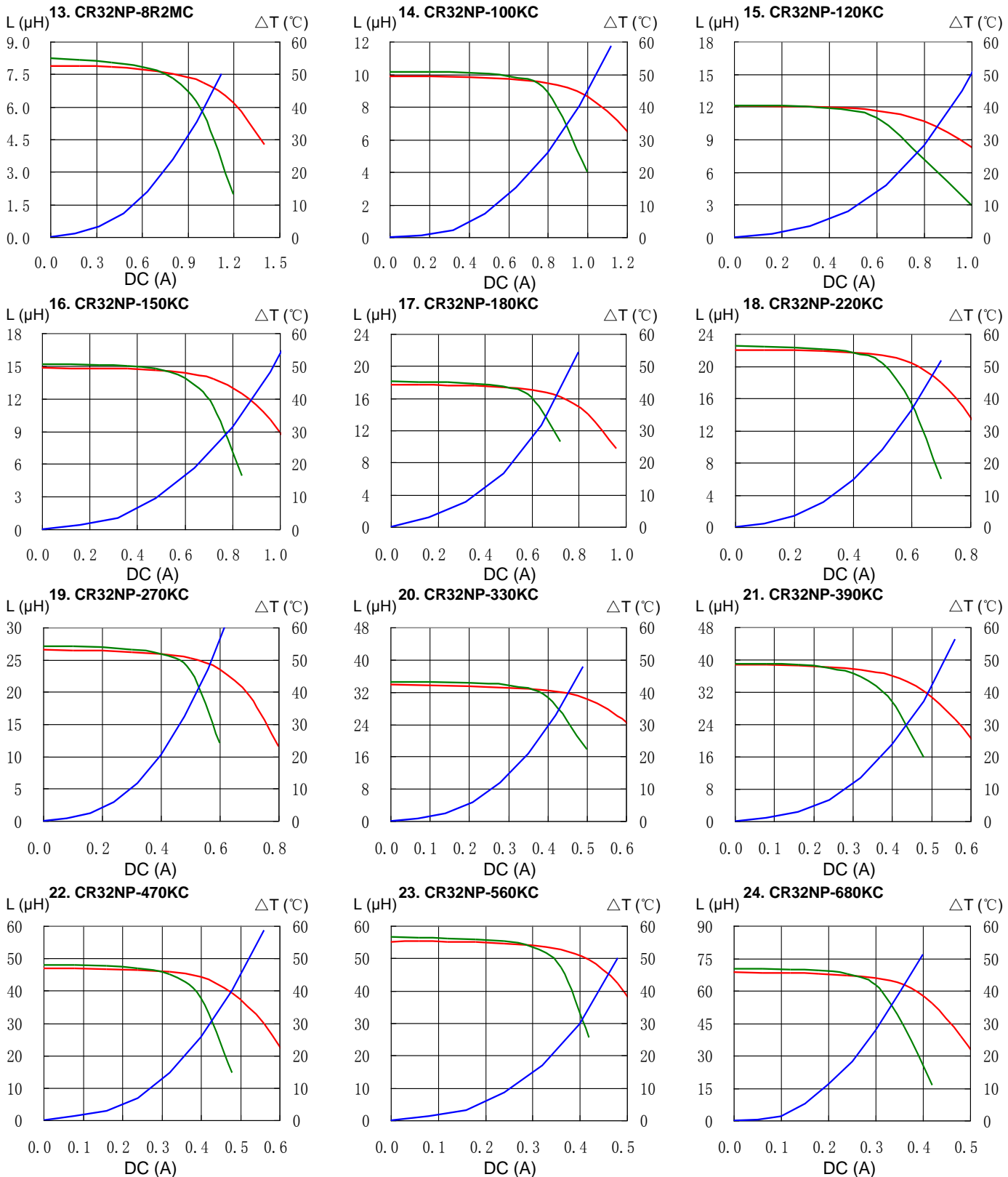

# SMD Power Inductor CR32



## Saturation Current & Temperature Rise Graph

— L (20°C) — L (100°C) —  $\Delta T$

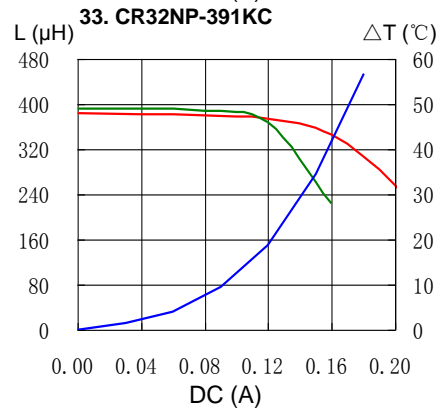
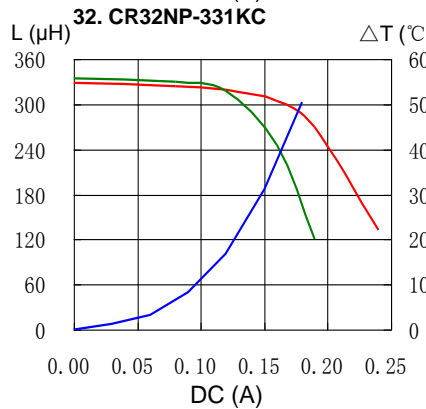
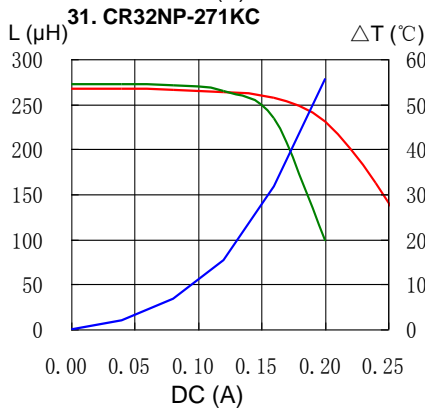
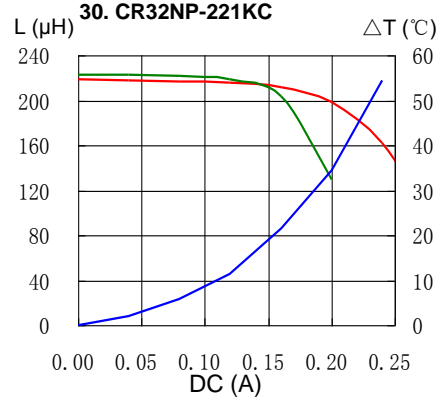
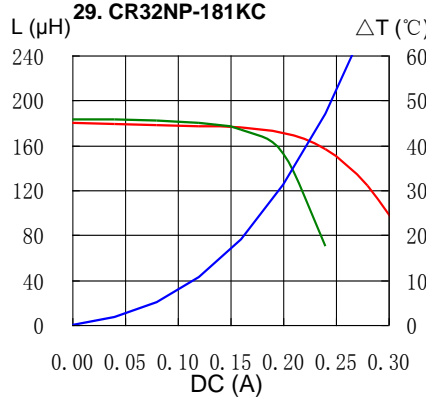
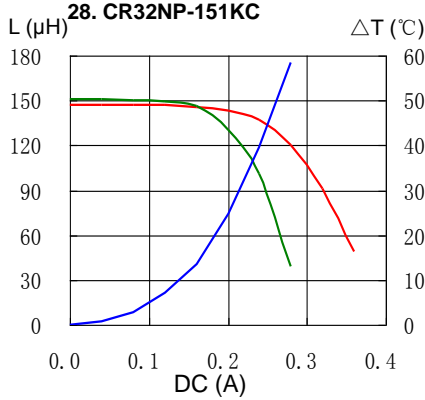
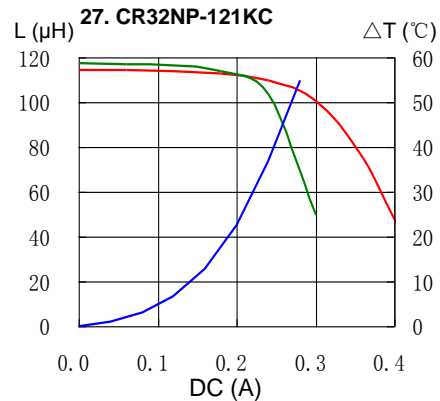
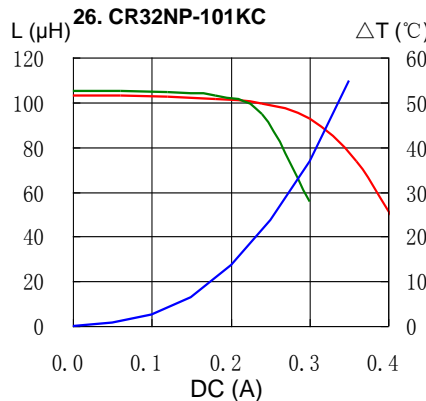
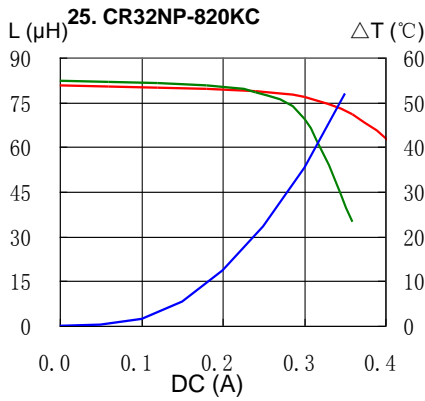

# SMD Power Inductor CR32

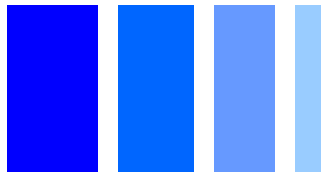

## Solder Reflow Condition

**Heat Endurance**

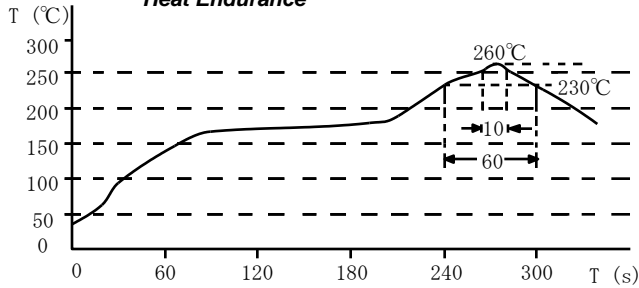

**Temperature Chart**

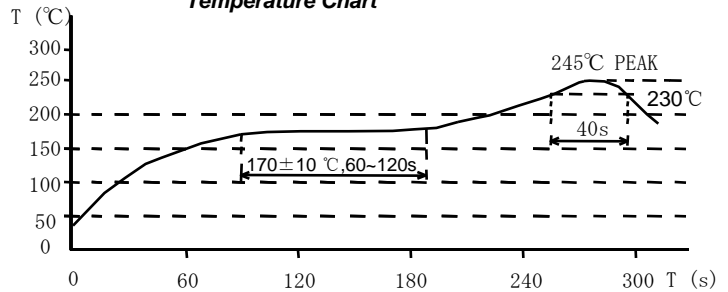

Please refer to the sales offices on our website - <http://www.sumida.com>

### Hong Kong

Tel. +852-2880-6781  
FAX. +852-2565-9600  
[sales@hk.sumida.com](mailto:sales@hk.sumida.com)

### Saitama(Japan)

Tel. +81-48-691-7300  
FAX. +81-48-691-7340  
[sales@jp.sumida.com](mailto:sales@jp.sumida.com)

### Chicago

Tel. +1-847-545-6700  
FAX. +1-847-545-6720  
[sales@us.sumida.com](mailto:sales@us.sumida.com)

### Shanghai

Tel. +86-21-5836-3299  
FAX. +86-21-5836-3266  
[shanghai.sales@cn.sumida.com](mailto:shanghai.sales@cn.sumida.com)

### Seoul

Tel. +82-2-6237-0777  
FAX. +82-2-6237-0778  
[sales@kr.sumida.com](mailto:sales@kr.sumida.com)

### Obernzell

Tel. +49-8591-937-0  
FAX. +49-8591-937-103  
[contact@eu.sumida.com](mailto:contact@eu.sumida.com)

### Shenzhen

Tel. +86-755-8291-0228  
FAX. +86-755-8291-0338  
[shenzhen.sales@cn.sumida.com](mailto:shenzhen.sales@cn.sumida.com)

### Singapore

Tel. +65-6296-3388  
FAX. +65-6841-4426  
[sales@sg.sumida.com](mailto:sales@sg.sumida.com)

### Neumarkt

Tel. +49-9181-4509-110  
FAX. +49-9181-4509-310  
[infocomp@eu.sumida.com](mailto:infocomp@eu.sumida.com)

### Taipei

Tel. +886-2-8751-2737  
FAX. +886-2-8751-2738  
[sales@tw.sumida.com](mailto:sales@tw.sumida.com)

### San Jose

Tel. +1-408-321-9660  
FAX. +1-408-321-9308  
[sales@us.sumida.com](mailto:sales@us.sumida.com)

# Mouser Electronics

Authorized Distributor

Click to View Pricing, Inventory, Delivery & Lifecycle Information:

[Sumida:](#)

[CR32NP-100KC](#)