

# SMD Power Inductor CDRH2D18/HP

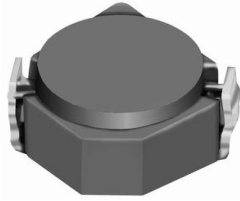

## Description

- Ferrite drum core construction.
- Magnetically shielded.
- L × W × H: 3.2 × 3.2 × 2.0 mm Max.
- Product weight: 65mg(Ref.)
- Moisture Sensitivity Level: 1
- RoHS compliance.

## Environmental Data

- Operating temperature range: -40°C ~ +105°C (including coil's self temperature rise)
- Storage temperature range: -40°C ~ +105°C
- Solder reflow temperature: 260 °C peak.

## Packaging

- Carrier tape and reel packaging
- 7.0" diameter reel
- 1000pcs per reel

## Applications

- Ideally used in Mobilephone, PDA, MP3, DSC/DVC, etc. as DC-DC converter inductors.

## Dimension - [mm]

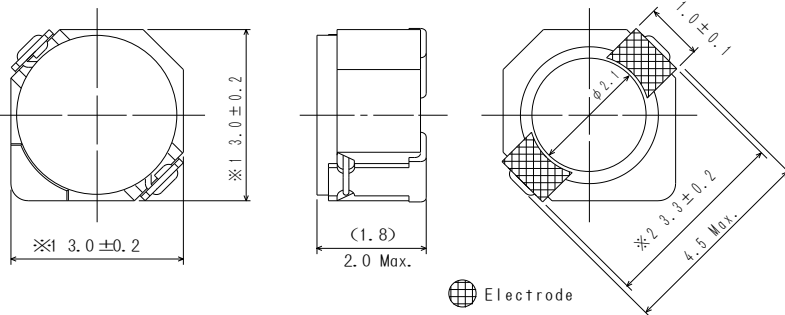

Electrode

## Land pattern and Schematics - [mm]

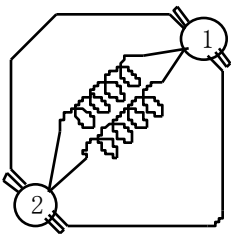
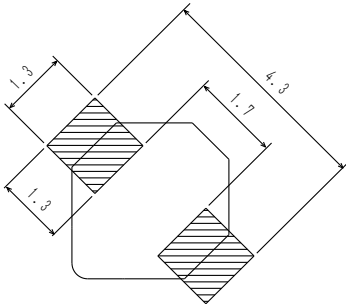

(0.20µH ~ 3.3µH)

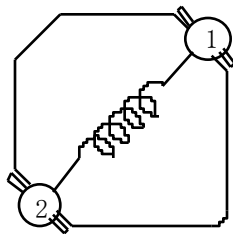

(4.7µH ~ 15µH)



### Electrical Characteristics

Part Name	Stamp	Inductance ( $\mu\text{H}$ ) [within] ※1	D.C.R. (m $\Omega$ ) Max. (Typ.) (at 20°C)	Saturation Current (A) ※2		Temperature Rise Current (A) ※3
				at 20°C	at 100°C	
CDRH2D18/HPNP-R20NC	N	0.20 $\pm$ 35%	22(17)	5.35	3.55	4.70
CDRH2D18/HPNP-R36NC	P	0.36 $\pm$ 35%	29(22)	4.62	3.00	4.10
CDRH2D18/HPNP-R56NC	Q	0.56 $\pm$ 35%	33(25)	3.75	2.76	3.60
CDRH2D18/HPNP-R82NC	R	0.82 $\pm$ 35%	39(30)	2.91	2.20	3.30
CDRH2D18/HPNP-1R1NC	S	1.10 $\pm$ 35%	43(33)	2.50	1.90	2.90
CDRH2D18/HPNP-1R7NC	A	1.70 $\pm$ 30%	44(35)	1.85	1.36	2.20
CDRH2D18/HPNP-2R2NC	C	2.20 $\pm$ 30%	60(48)	1.60	1.15	1.90
CDRH2D18/HPNP-3R3NC	E	3.30 $\pm$ 30%	86(69)	1.45	1.10	1.55
CDRH2D18/HPNP-4R7NC	G	4.70 $\pm$ 30%	140(110)	1.20	0.90	1.20
CDRH2D18/HPNP-6R3NC	I	6.30 $\pm$ 30%	160(128)	1.05	0.78	1.15
CDRH2D18/HPNP-100NC	K	10.0 $\pm$ 30%	245(195)	0.85	0.65	0.90
CDRH2D18/HPNP-150NC	M	15.0 $\pm$ 30%	345(275)	0.70	0.53	0.64

※1. Inductance measuring condition: 0.20 $\mu\text{H}$ ~1.10 $\mu\text{H}$  at 7.96MHz ; 1.70 $\mu\text{H}$ ~15.0 $\mu\text{H}$  at 100kHz

※2. Saturation current: The value of D.C. current when the inductance decreases to 65% of it's nominal value.

※3. Temperature rise current: The value of D.C. current when the temperature rise is  $\Delta t=40^\circ\text{C}$  ( $T_a=20^\circ\text{C}$ ).

# SMD Power Inductor CDRH2D18/HP



## Saturation Current & Temperature Rise Graph

— L (20°C) — L (100°C) —  $\Delta T$

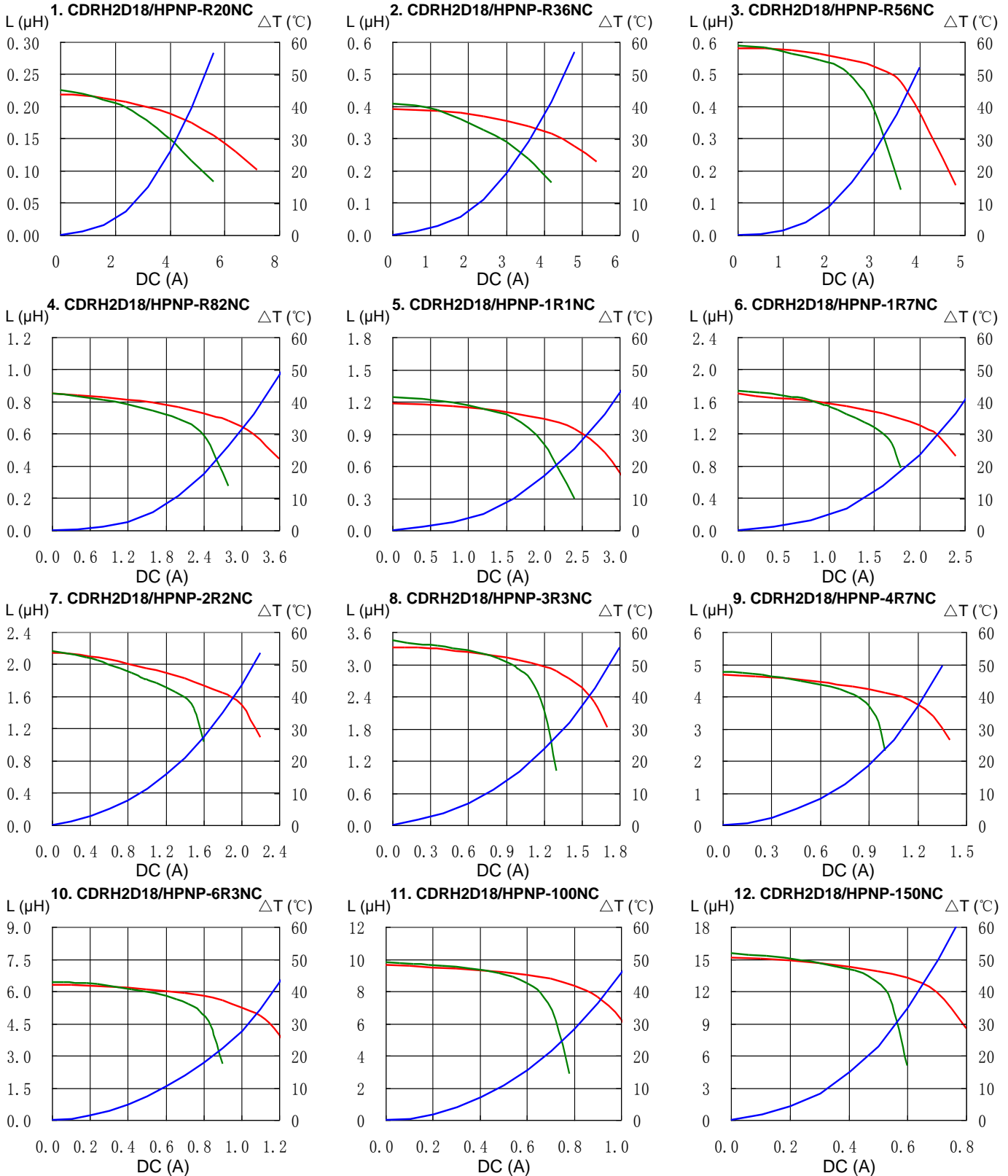

# SMD Power Inductor CDRH2D18/HP



## Solder Reflow Condition

**Heat Endurance**

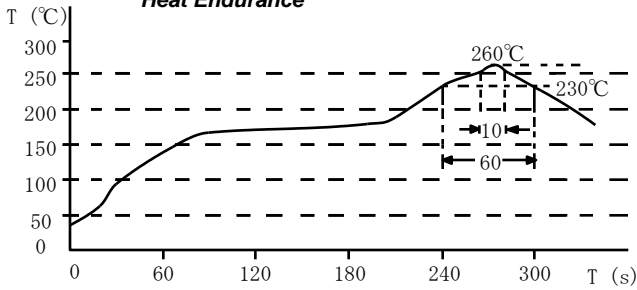

**Temperature Chart**

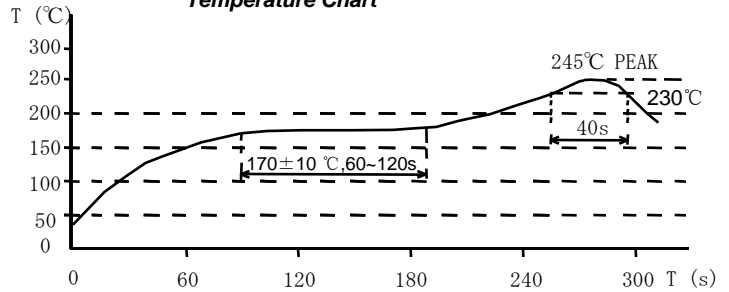

Please refer to the sales offices on our website - <http://www.sumida.com>

### Hong Kong

Tel.+852-2880-6781  
FAX.+852-2565-9600  
[sales@hk.sumida.com](mailto:sales@hk.sumida.com)

### Saitama(Japan)

Tel.+81-48-691-7300  
FAX.+81-48-691-7340  
[sales@jp.sumida.com](mailto:sales@jp.sumida.com)

### Chicago

Tel.+1-847-545-6700  
FAX. +1-847-545-6720  
[sales@us.sumida.com](mailto:sales@us.sumida.com)

### Shanghai

Tel.+86-21-5836-3299  
FAX.+86-21-5836-3266  
[shanghai.sales@cn.sumida.com](mailto:shanghai.sales@cn.sumida.com)

### Seoul

Tel.+82-2-6237-0777  
FAX.+82-2-6237-0778  
[sales@kr.sumida.com](mailto:sales@kr.sumida.com)

### Obernzell

Tel.+49-8591-937-0  
FAX. +49-8591-937-103  
[contact@eu.sumida.com](mailto:contact@eu.sumida.com)

### Shenzhen

Tel.+86-755-8291-0228  
FAX.+86-755-8291-0338  
[shenzhen.sales@cn.sumida.com](mailto:shenzhen.sales@cn.sumida.com)

### Singapore

Tel.+65-6296-3388  
FAX.+65-6841-4426  
[sales@sg.sumida.com](mailto:sales@sg.sumida.com)

### Neumarkt

Tel.+49-9181-4509-110  
FAX. +49-9181-4509-310  
[infocomp@eu.sumida.com](mailto:infocomp@eu.sumida.com)

### Taipei

Tel.+886-2-8751-2737  
FAX.+886-2-8751-2738  
[sales@tw.sumida.com](mailto:sales@tw.sumida.com)

### San Jose

Tel.+1-408-321-9660  
FAX.+1-408-321-9308  
[sales@us.sumida.com](mailto:sales@us.sumida.com)

# Mouser Electronics

Authorized Distributor

Click to View Pricing, Inventory, Delivery & Lifecycle Information:

## Sumida:

[CDRH2D18/HPNP-6R3NC](#) [CDRH2D18/LDNP-6R8NC](#) [CDRH2D18/LDNP-100NC](#) [CDRH2D18/LDNP-470NC](#)  
[CDRH2D18/HPNP-3R3NC](#) [CDRH2D18/HPNP-4R7NC](#) [CDRH2D18/HPNP-R20NC](#) [CDRH2D18/HPNP-1R1NC](#)  
[CDRH2D18/HPNP-R82NC](#) [CDRH2D18/HPNP-R36NC](#) [CDRH2D18/LDNP-2R2NC](#) [CDRH2D18/LDNP-3R3NC](#)  
[CDRH2D18/HPNP-R56NC](#) [CDRH2D18/LDNP-330NC](#) [CDRH2D18/LDNP-150NC](#)