

# SMD Power Inductor CDRH2D11/HP

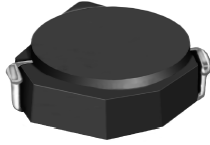

## Description

- Ferrite drum core construction.
- Magnetically shielded.
- L × W × H: 3.2 × 3.2 × 1.2 mm Max.
- Product weight: 37mg(Ref.)
- Moisture Sensitivity Level: 1
- RoHS compliance.

## Environmental Data

- Operating temperature range: -40°C ~ +105°C (including coil's self temperature rise)
- Storage temperature range: -40°C ~ +105°C
- Solder reflow temperature: 260 °C peak.

## Packaging

- Carrier tape and reel packaging
- 7.0" diameter reel
- 1500pcs per reel

## Applications

- Ideally used in Mobilephone, PDA, MP3, DSC/DVC, Portable DVD, etc as DC-DC converter.

## Dimension - [mm]

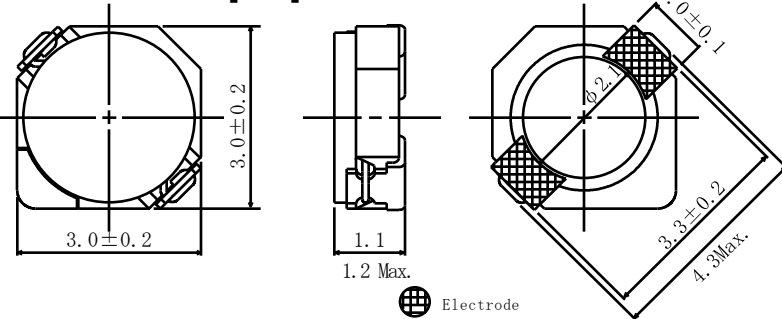

## Land pattern and Schematics - [mm]

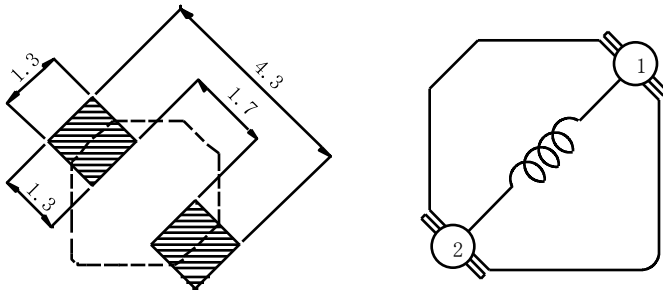

## Electrical Characteristics

Part Name	Stamp	Inductance (μH) [ within ] ※1	D.C.R. (mΩ) Max. (Typ.) (at 20°C)	Saturation Current (A) ※2		Temperature Rise Current (A) ※3
				at 20°C	at 100°C	
CDRH2D11/HPNP-1R5NC	A	1.5 ± 30%	80(64)	1.35	1.0	1.60
CDRH2D11/HPNP-2R2NC	C	2.2 ± 30%	120(96)	1.10	0.72	1.30
CDRH2D11/HPNP-3R3NC	E	3.3 ± 30%	173(138)	0.90	0.65	0.90
CDRH2D11/HPNP-4R7NC	G	4.7 ± 30%	238(190)	0.75	0.52	0.85
CDRH2D11/HPNP-6R8NC	I	6.8 ± 30%	371(297)	0.63	0.45	0.65
CDRH2D11/HPNP-100NC	K	10.0 ± 30%	559(447)	0.52	0.37	0.52

※1. Inductance measuring condition: at 100kHz.

※2. Saturation current: The value of D.C. current when the inductance decreases to 65% of its nominal value.

※3. Temperature rise current: The value of D.C. current when the temperature rise is  $\Delta t = 40^\circ\text{C}$  ( $T_a = 20^\circ\text{C}$ ).

# SMD Power Inductor CDRH2D11/HP



## Saturation Current & Temperature Rise Graph

— L (20°C) — L (100°C) —  $\Delta T$

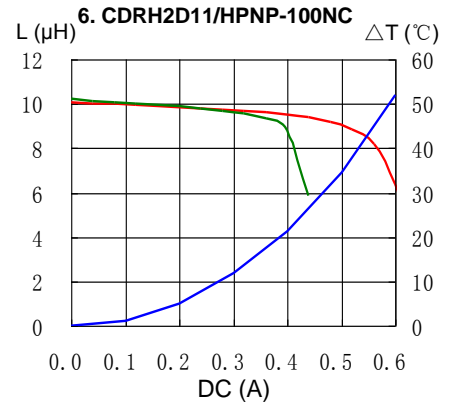
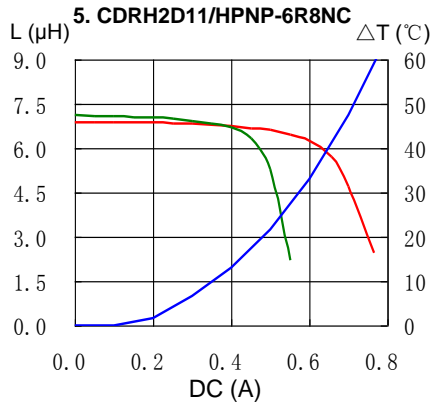
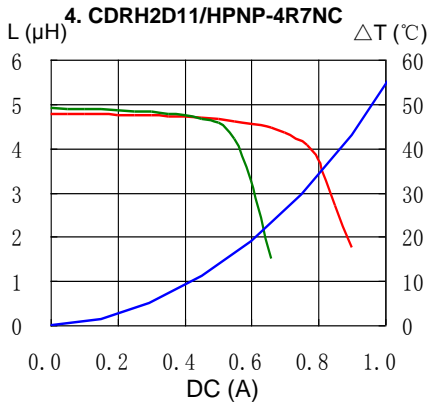
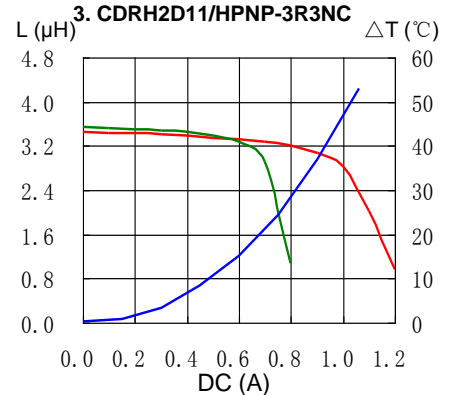
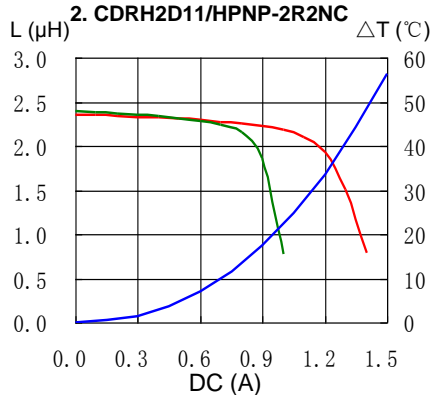
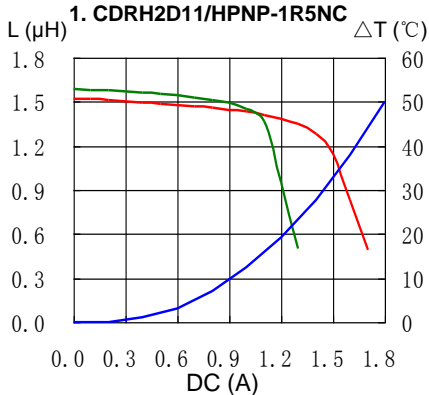

## Solder Reflow Condition

Heat Endurance

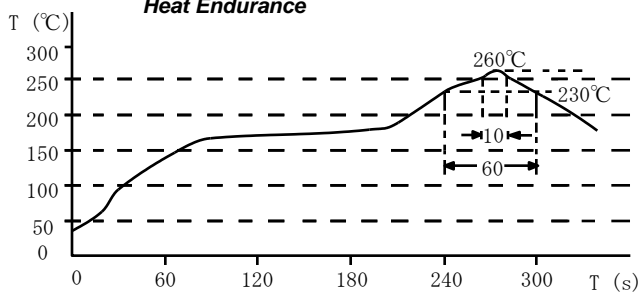

Temperature Chart

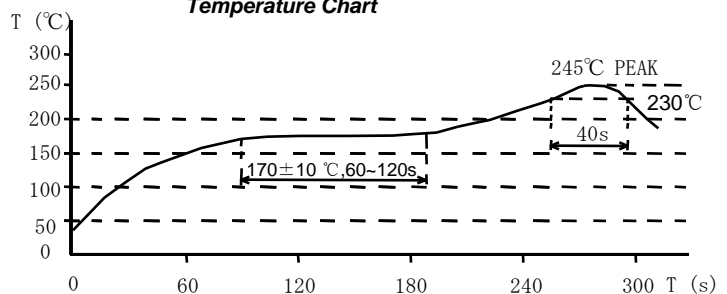

Please refer to the sales offices on our website - <http://www.sumida.com>

### Hong Kong

Tel.+852-2880-6781  
FAX.+852-2565-9600  
[sales@hk.sumida.com](mailto:sales@hk.sumida.com)

### Saitama(Japan)

Tel.+81-48-691-7300  
FAX.+81-48-691-7340  
[sales@jp.sumida.com](mailto:sales@jp.sumida.com)

### Chicago

Tel.+1-847-545-6700  
FAX. +1-847-545-6720  
[sales@us.sumida.com](mailto:sales@us.sumida.com)

### Shanghai

Tel.+86-21-5836-3299  
FAX.+86-21-5836-3266  
[shanghai.sales@cn.sumida.com](mailto:shanghai.sales@cn.sumida.com)

### Seoul

Tel.+82-2-6237-0777  
FAX.+82-2-6237-0778  
[sales@kr.sumida.com](mailto:sales@kr.sumida.com)

### Obernzell

Tel.+49-8591-937-0  
FAX. +49-8591-937-103  
[contact@eu.sumida.com](mailto:contact@eu.sumida.com)

### Shenzhen

Tel.+86-755-8291-0228  
FAX.+86-755-8291-0338  
[shenzhen.sales@cn.sumida.com](mailto:shenzhen.sales@cn.sumida.com)

### Singapore

Tel.+65-6296-3388  
FAX.+65-6841-4426  
[sales@sg.sumida.com](mailto:sales@sg.sumida.com)

### Neumarkt

Tel.+49-9181-4509-110  
FAX. +49-9181-4509-310  
[infocomp@eu.sumida.com](mailto:infocomp@eu.sumida.com)

### Taipei

Tel.+886-2-8751-2737  
FAX.+886-2-8751-2738  
[sales@tw.sumida.com](mailto:sales@tw.sumida.com)

### San Jose

Tel.+1-408-321-9660  
FAX.+1-408-321-9308  
[sales@us.sumida.com](mailto:sales@us.sumida.com)

# Mouser Electronics

Authorized Distributor

Click to View Pricing, Inventory, Delivery & Lifecycle Information:

Sumida:

[CDRH2D11/HPNP-3R4NC](#) [CDRH2D11/HPNP-1R5NC](#) [CDRH2D11/HPNP-2R2NC](#) [CDRH2D11/HPNP-3R3NC](#)  
[CDRH2D11/HPNP-4R7NC](#) [CDRH2D11/HPNP-100NC](#) [CDRH2D11/HPNP-6R8NC](#)