

## High temperature 40 A SCRs

Datasheet - production data

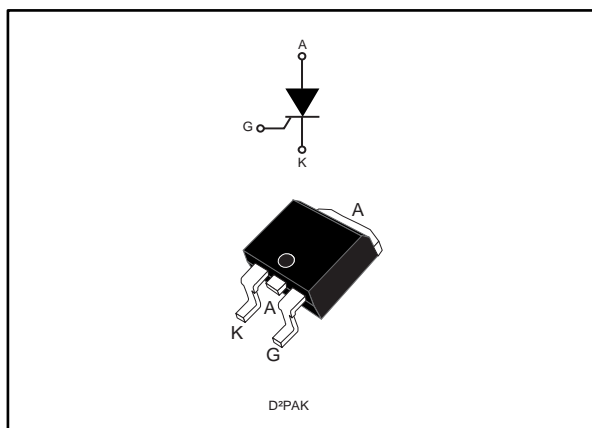

### Description

Thanks to its junction temperature  $T_j$  up to 150 °C, the device offers high thermal performance operation up to 40 A. Its D<sup>2</sup>PAK package allows modern SMD designs as well as compact back to back configuration.

Its trade-off noise immunity ( $dV/dt = 500 \text{ V}/\mu\text{s}$ ) versus its gate triggering current ( $I_{GT} = 15 \text{ mA}$ ) and its turn-on current rise ( $dI/dt = 100 \text{ A}/\mu\text{s}$ ) allow to design robust and compact control circuit for voltage regulator in motorbikes and industrial drives, overvoltage crowbar protection, motor control circuits in power tools and kitchen appliances, inrush current limiting circuits.

### Features

- High junction temperature:  $T_j = 150 \text{ °C}$
- High noise immunity  $dV/dt = 500 \text{ V}/\mu\text{s}$  up to 150 °C
- Gate triggering current  $I_{GT} = 15 \text{ mA}$
- Off-state voltage 600 V  $V_{DRM}/V_{RRM}$
- High turn on current rise  $dI/dt = 100 \text{ A}/\mu\text{s}$
- ECOPACK<sup>®</sup>2 compliant component

**Table 1: Device summary**

Order code	Package	$V_{DRM}/V_{RRM}$	$I_{GT}$
TN4015H-6G	D <sup>2</sup> PAK	600 V	15 mA

### Applications

- Motorbike voltage regulator circuits
- Inrush current limiting circuit
- Motor control circuits and starters
- Solid state relays

# 1 Characteristics

**Table 2: Absolute maximum ratings (limiting values),  $T_j = 25\text{ °C}$  unless otherwise specified**

Symbol	Parameter		Value	Unit
$I_{T(RMS)}$	RMS on-state current (180 ° conduction angle)		$T_c = 119\text{ °C}$ 40	A
$I_{T(AV)}$	Average on-state current (180 ° conduction angle)		$T_c = 120\text{ °C}$ 25	A
			$T_c = 125\text{ °C}$ 22	
			$T_c = 128\text{ °C}$ 20	
$I_{TSM}$	Non repetitive surge peak on-state current		$t_p = 8.3\text{ ms}$ 394	A
			$t_p = 10\text{ ms}$ 360	
$I^2t$	$I^2t$ value for fusing		$t_p = 10\text{ ms}$ 648	$A^2s$
$di/dt$	Critical rate of rise of on-state current $I_G = 2 \times I_{GT}$ , $t_r \leq 100\text{ ns}$		$f = 60\text{ Hz}$ 100	$A/\mu s$
$V_{DRM}/V_{RRM}$	Repetitive peak off-state voltage		$T_j = 150\text{ °C}$ 600	V
$V_{DSM}/V_{RSM}$	Non repetitive surge peak off-state voltage		$t_p = 10\text{ ms}$ $V_{DRM}/V_{RRM} + 100$	V
$I_{GM}$	Peak gate current	$t_p = 20\text{ }\mu s$	$T_j = 150\text{ °C}$ 4	A
$P_{G(AV)}$	Average gate power dissipation		$T_j = 150\text{ °C}$ 1	W
$V_{RGM}$	Maximum peak reverse gate voltage		5	V
$T_{stg}$	Storage junction temperature range		-40 to +150	$^{\circ}C$
$T_j$	Maximum operating junction temperature		-40 to +150	$^{\circ}C$

**Table 3: Electrical characteristics ( $T_j = 25\text{ °C}$  unless otherwise specified)**

Symbol	Test conditions		Value	Unit	
$I_{GT}$	$V_D = 12\text{ V}$ , $R_L = 33\text{ }\Omega$		Max.	15	mA
$V_{GT}$			Max.	1.3	V
$V_{GD}$	$V_D = V_{DRM}$ , $R_L = 3.3\text{ k}\Omega$	$T_j = 150\text{ °C}$	Min.	0.15	V
$I_H$	$I_T = 500\text{ mA}$ , gate open		Max.	60	mA
$I_L$	$I_G = 1.2 \times I_{GT}$		Max.	80	mA
$dV/dt$	$V_D = 402\text{ V}$ , gate open	$T_j = 150\text{ °C}$	Min.	500	$V/\mu s$
$t_{gt}$	$I_{TM} = 80\text{ A}$ , $V_D = 402\text{ V}$ , $I_G = 30\text{ mA}$ , $(di_G/dt)_{max} = 0.2\text{ A}/\mu s$		Typ.	1.9	$\mu s$
$t_q$	$I_{TM} = 80\text{ A}$ , $V_D = 402\text{ V}$ , $(di/dt)_{off} = 30\text{ A}/\mu s$ , $V_R = 25\text{ V}$ , $dV_D/dt = 50\text{ V}/\mu s$	$T_j = 150\text{ °C}$	Typ.	85	$\mu s$

Table 4: Static characteristics

Symbol	Test conditions			Value	Unit
$V_{TM}$	$I_{TM} = 80 \text{ A}$ , $t_p = 380 \text{ } \mu\text{s}$	$T_j = 25 \text{ }^\circ\text{C}$	Max.	1.6	V
$V_{TO}$	Threshold voltage	$T_j = 150 \text{ }^\circ\text{C}$	Max.	0.85	
$R_D$	Dynamic resistance	$T_j = 150 \text{ }^\circ\text{C}$	Max.	10	m $\Omega$
$I_{DRM}$ , $I_{RRM}$	$V_D = V_{DRM} = V_{RRM}$	$T_j = 25 \text{ }^\circ\text{C}$	Max.	10	$\mu\text{A}$
		$T_j = 150 \text{ }^\circ\text{C}$		6	mA

Table 5: Thermal parameters

Symbol	Parameter		Value	Unit	
$R_{th(j-c)}$	Junction to case (DC)		Max.	0.8	$^\circ\text{C/W}$
$R_{th(j-a)}$	Junction to ambient (DC)	$S^{(1)} = 1 \text{ cm}^2$	Typ.	45	

**Notes:**<sup>(1)</sup>S = Copper surface under tab

# 1.1 Characteristics (curves)

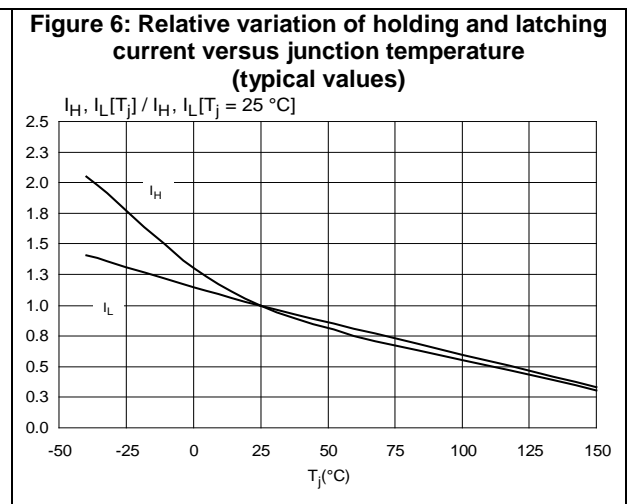
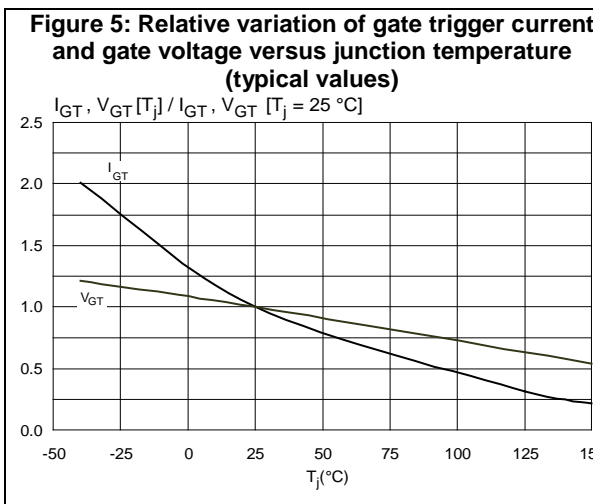
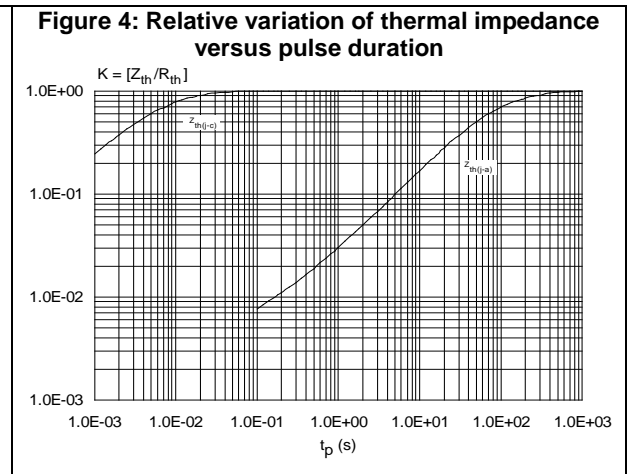
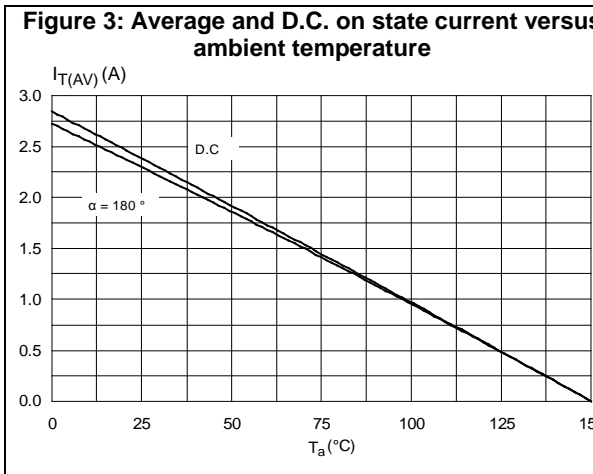
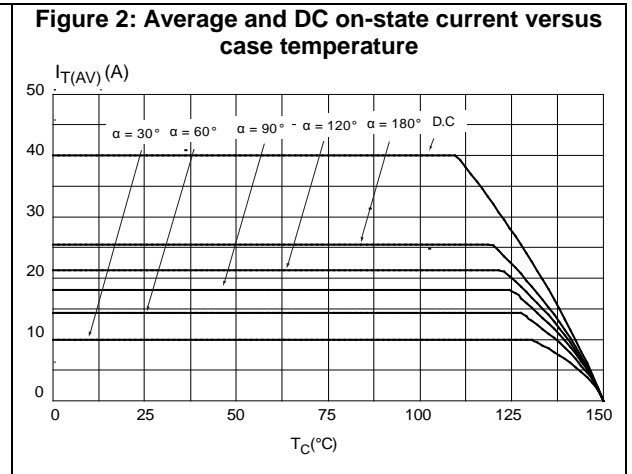
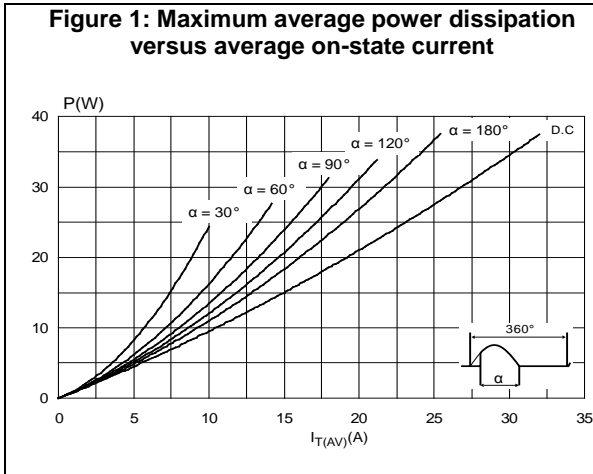

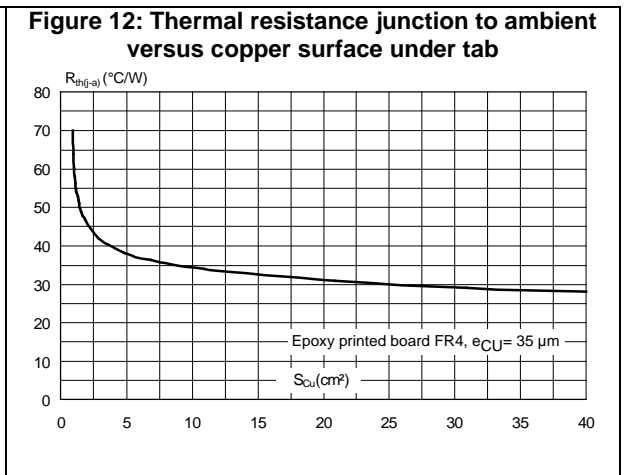
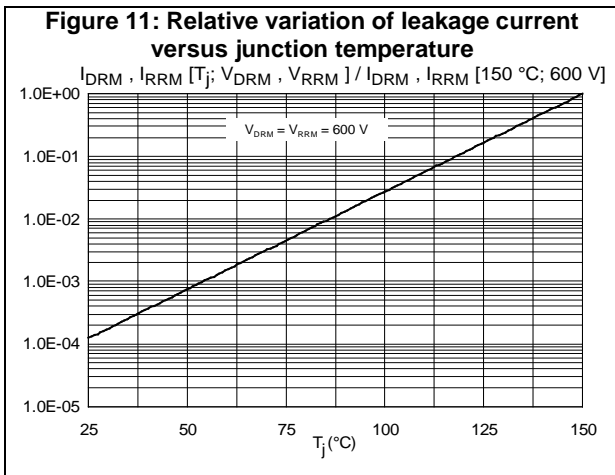
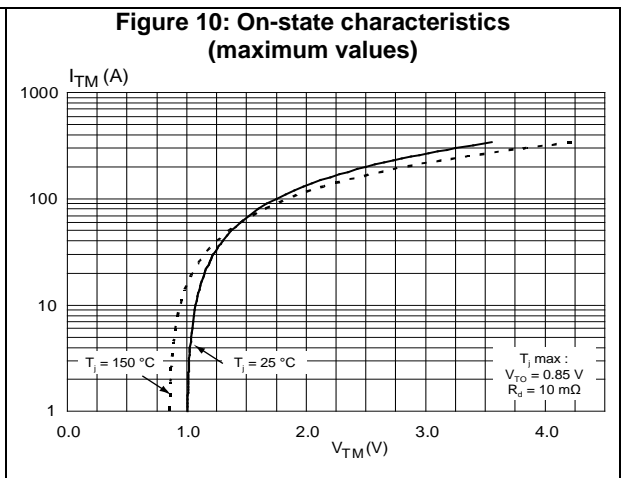
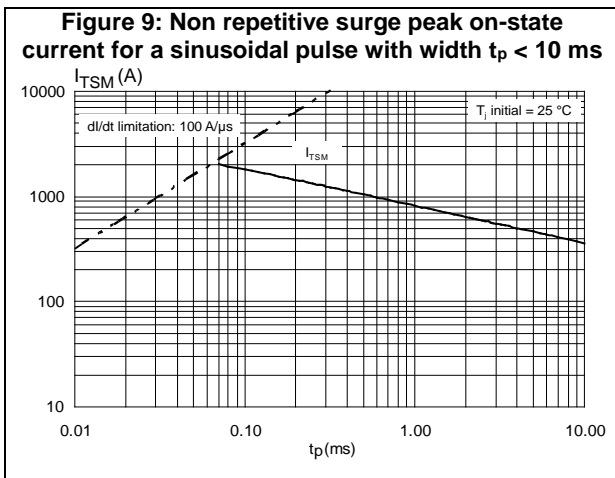
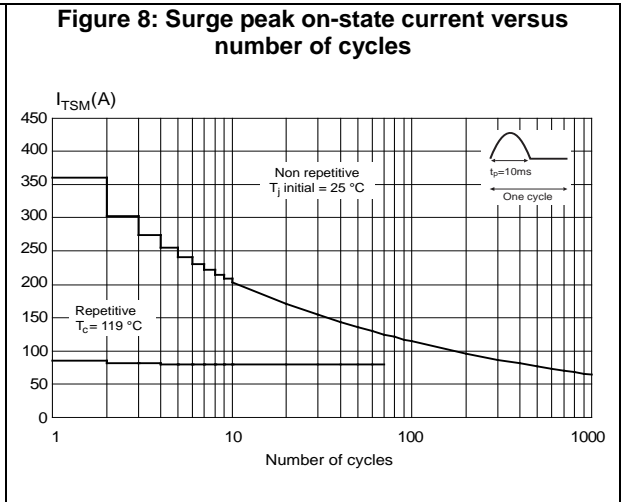
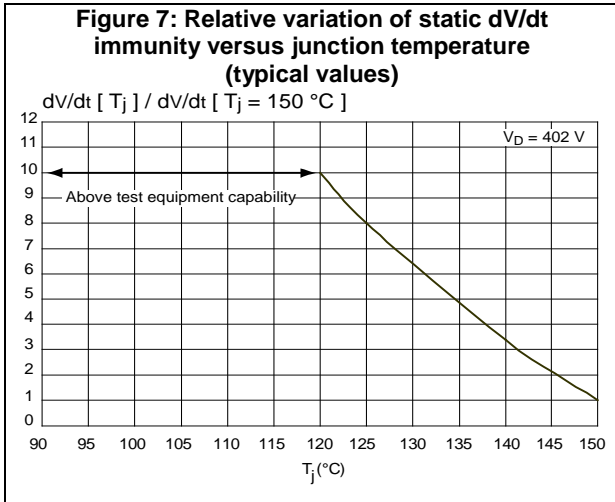

## 2 Package information

In order to meet environmental requirements, ST offers these devices in different grades of ECOPACK® packages, depending on their level of environmental compliance. ECOPACK® specifications, grade definitions and product status are available at: [www.st.com](http://www.st.com). ECOPACK® is an ST trademark.

- Epoxy meets UL94, V0
- Lead-free, halogen-free package

### 2.1 D<sup>2</sup>PAK package information

Figure 13: D<sup>2</sup>PAK package outline

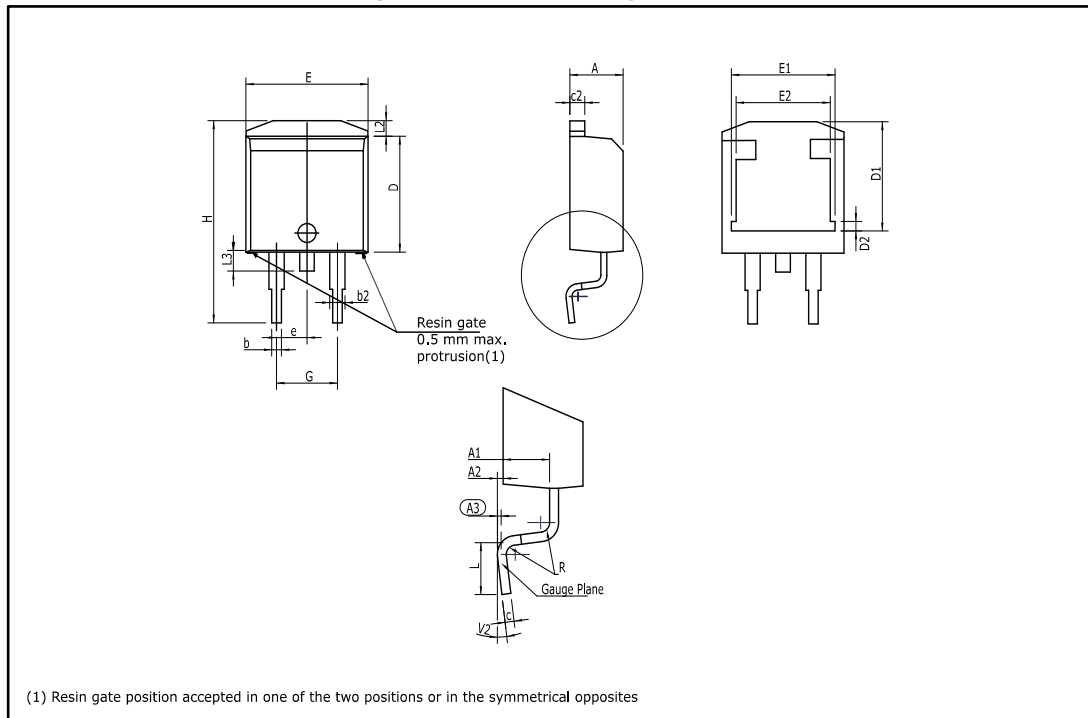
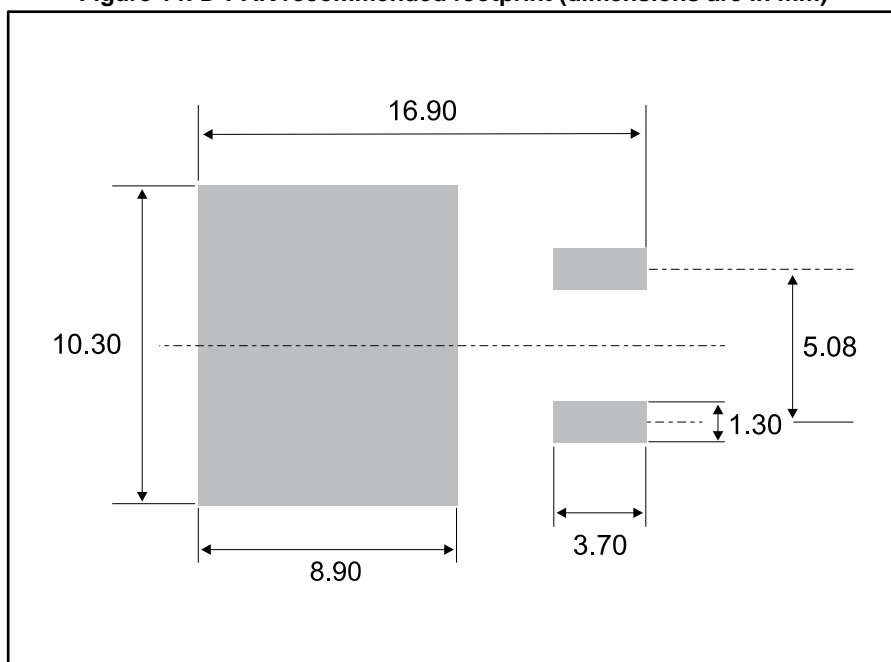

Table 6: D<sup>2</sup>PAK package mechanical data

Ref.	Dimensions					
	Millimeters			Inches <sup>(1)</sup>		
	Min.	Typ.	Max.	Min.	Typ.	Max.
A	4.30		4.60	0.1693		0.1811
A1	2.49		2.69	0.0980		0.1059
A2	0.03		0.23	0.0012		0.0091
A3		0.25			0.0098	
b	0.70		0.93	0.0276		0.0366
b2	1.25		1.7	0.0492		0.0669
c	0.45		0.60	0.0177		0.0236
c2	1.21		1.36	0.0476		0.0535
D	8.95		9.35	0.3524		0.3681
D1	7.50		8.00	0.2953		0.3150
D2	1.30		1.70	0.0512		0.0669
e	2.54			0.1		
E	10.00		10.28	0.3937		0.4047
E1	8.30		8.70	0.3268		0.3425
E2	6.85		7.25	0.2697		0.2854
G	4.88		5.28	0.1921		0.2079
H	15		15.85	0.5906		0.6240
L	1.78		2.28	0.0701		0.0898
L2	1.27		1.40	0.0500		0.0551
L3	1.40		1.75	0.0551		0.0689
R		0.40			0.0157	
V2	0°		8°	0°		8°

**Notes:**<sup>(1)</sup>Dimensions in inches are given for reference only

Figure 14: D<sup>2</sup>PAK recommended footprint (dimensions are in mm)





### 3 Ordering information

Figure 15: Ordering information scheme

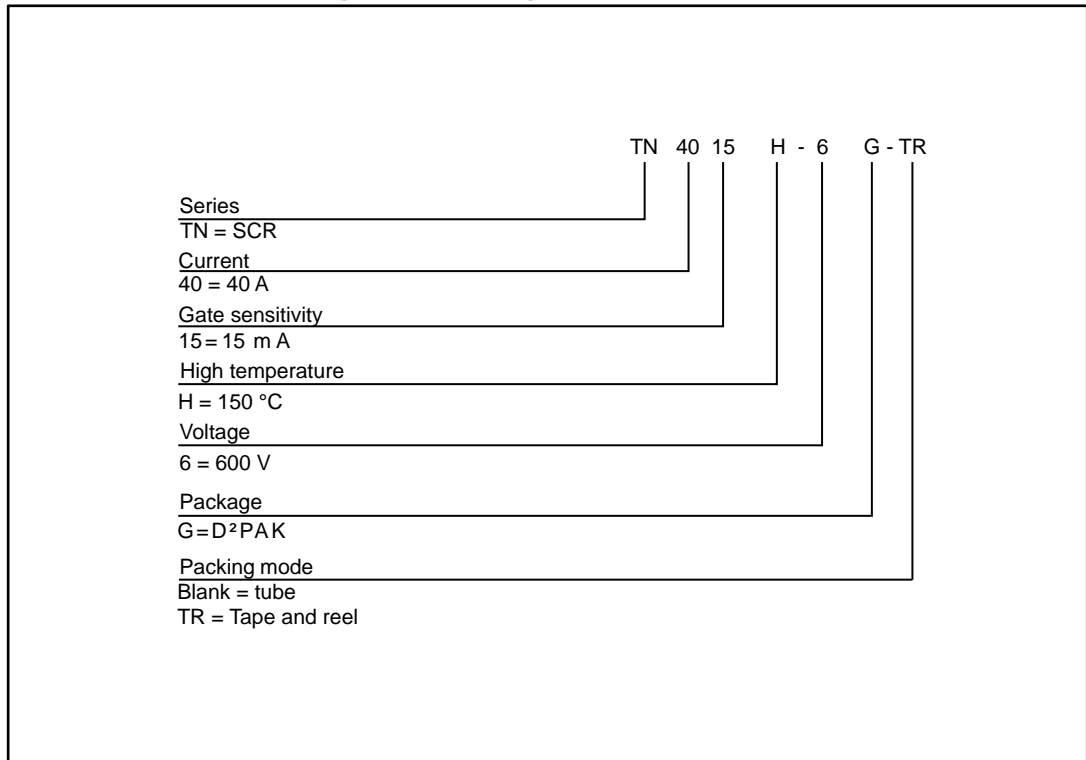

Table 7: Ordering information

Order code	Marking	Package	Weight	Base qty.	Delivery mode
TN4015H-6G	TN4015H6	D <sup>2</sup> PAK	1.5 g	50	Tube
TN4015H-6G-TR	TN4015H6	D <sup>2</sup> PAK	1.5 g	1000	Tape and reel

### 4 Revision history

Table 8: Document revision history

Date	Revision	Changes
01-Aug-2016	1	Initial release.
22-May-2017	2	Updated <a href="#">Figure 13: "D<sup>2</sup>PAK package outline"</a> .

**IMPORTANT NOTICE – PLEASE READ CAREFULLY**

STMicroelectronics NV and its subsidiaries ("ST") reserve the right to make changes, corrections, enhancements, modifications, and improvements to ST products and/or to this document at any time without notice. Purchasers should obtain the latest relevant information on ST products before placing orders. ST products are sold pursuant to ST's terms and conditions of sale in place at the time of order acknowledgement.

Purchasers are solely responsible for the choice, selection, and use of ST products and ST assumes no liability for application assistance or the design of Purchasers' products.

No license, express or implied, to any intellectual property right is granted by ST herein.

Resale of ST products with provisions different from the information set forth herein shall void any warranty granted by ST for such product.

ST and the ST logo are trademarks of ST. All other product or service names are the property of their respective owners.

Information in this document supersedes and replaces information previously supplied in any prior versions of this document.

© 2017 STMicroelectronics – All rights reserved

# Mouser Electronics

Authorized Distributor

Click to View Pricing, Inventory, Delivery & Lifecycle Information:

[STMicroelectronics:](#)

[TN4015H-6G](#) [TN4015H-6G-TR](#)