



# STB70N10F4, STD70N10F4 STP70N10F4, STW70N10F4

N-channel 100 V, 0.015  $\Omega$ , 60 A, STripFET™ DeepGATE™  
Power MOSFET in TO-220, DPAK, TO-247, D<sup>2</sup>PAK

## Features

Type	V <sub>DSS</sub>	R <sub>DS(on)</sub> max	I <sub>D</sub>
STB70N10F4	100 V	< 0.0195 $\Omega$	65 A
STD70N10F4	100 V	< 0.0195 $\Omega$	60 A
STP70N10F4	100 V	< 0.0195 $\Omega$	65 A
STW70N10F4	100 V	< 0.0195 $\Omega$	65 A

- Exceptional dv/dt capability
- Extremely low on-resistance R<sub>DS(on)</sub>
- 100% avalanche tested

## Application

- Switching applications

## Description

This STripFET™ DeepGATE™ Power MOSFET technology is among the latest improvements, which have been especially tailored to minimize on-state resistance, with a new gate structure, providing superior switching performance.

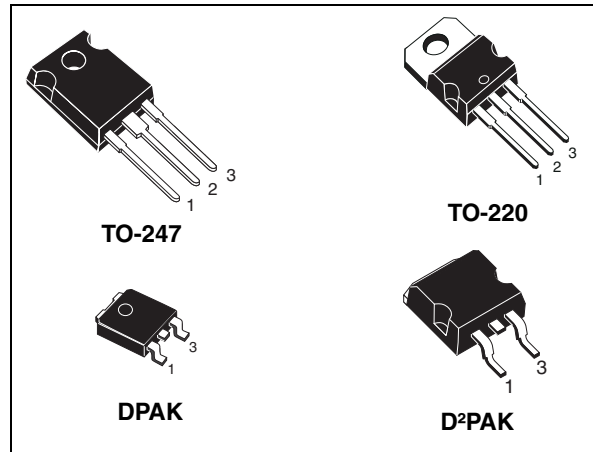

Figure 1. Internal schematic diagram

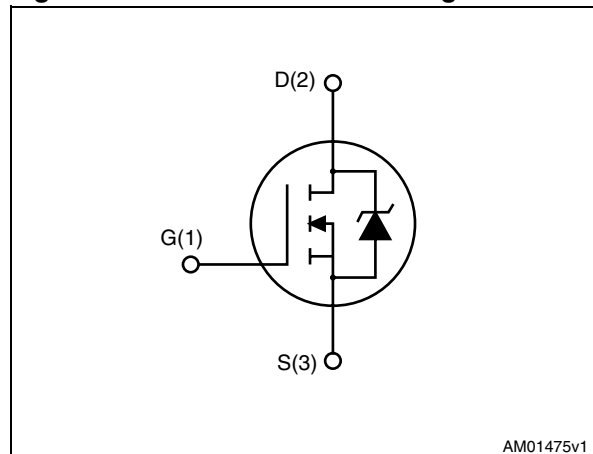

Table 1. Device summary

Order codes	Marking	Package	Packaging
STB70N10F4	70N10F4	D <sup>2</sup> PAK	Tape and reel
STD70N10F4	70N10F4	DPAK	Tape and reel
STP70N10F4	70N10F4	TO-220	Tube
STW70N10F4	70N10F4	TO-247	Tube

# Contents

<b>1</b>	<b>Electrical ratings</b> .....	<b>3</b>
<b>2</b>	<b>Electrical characteristics</b> .....	<b>4</b>
2.1	Electrical characteristics (curves) .....	6
<b>3</b>	<b>Test circuits</b> .....	<b>9</b>
<b>4</b>	<b>Package mechanical data</b> .....	<b>10</b>
<b>5</b>	<b>Packaging mechanical data</b> .....	<b>15</b>
<b>6</b>	<b>Revision history</b> .....	<b>17</b>

# 1 Electrical ratings

**Table 2. Absolute maximum ratings**

Symbol	Parameter	Value		Unit
		TO-220, TO-247, D <sup>2</sup> PAK	DPAK	
$V_{DS}$	Drain-source voltage ( $V_{GS} = 0$ )	100		V
$V_{GS}$	Gate-source voltage	$\pm 20$		V
$I_D$	Drain current (continuous) at $T_C = 25\text{ }^\circ\text{C}$	65	60	A
$I_D$	Drain current (continuous) at $T_C = 100\text{ }^\circ\text{C}$	46	43	A
$I_{DM}^{(1)}$	Drain current (pulsed)	260	240	A
$P_{TOT}$	Total dissipation at $T_C = 25\text{ }^\circ\text{C}$	150	125	W
	Derating factor	1	0.83	W/ $^\circ\text{C}$
$E_{AS}^{(2)}$	Single pulse avalanche energy	120		mJ
$T_{stg}$	Storage temperature	– 55 to 175		$^\circ\text{C}$
$T_j$	Max. operating junction temperature			

1. Pulse width limited by safe operating area

2. Starting  $T_j = 25\text{ }^\circ\text{C}$ ,  $I_D = 32.5\text{ A}$ ,  $V_{DD} = 45\text{ V}$

**Table 3. Thermal data**

Symbol	Parameter	Value		Unit
		TO-220, TO-247, D <sup>2</sup> PAK	DPAK	
$R_{thj-case}$	Thermal resistance junction-case max	1	1.2	$^\circ\text{C}/\text{W}$
$R_{thj-a}$	Thermal resistance junction-ambient max	62.5	50 <sup>(1)</sup>	$^\circ\text{C}/\text{W}$
$T_l$	Maximum lead temperature for soldering purpose	300		$^\circ\text{C}$

1. When mounted on FR-4 board of 1 inch<sup>2</sup>, 2 oz Cu

## 2 Electrical characteristics

( $T_{CASE} = 25\text{ °C}$  unless otherwise specified)

**Table 4. On/off states**

Symbol	Parameter	Test conditions	Min.	Typ.	Max.	Unit
$V_{(BR)DSS}$	Drain-source Breakdown voltage	$I_D = 250\ \mu\text{A}$ , $V_{GS} = 0$	100			V
$I_{DSS}$	Zero gate voltage Drain current ( $V_{GS} = 0$ )	$V_{DS} = \text{max rating}$ $V_{DS} = \text{max rating}$ , $T_C = 125\text{ °C}$			1 100	$\mu\text{A}$ $\mu\text{A}$
$I_{GSS}$	Gate-body leakage current ( $V_{DS} = 0$ )	$V_{GS} = \pm 20\text{ V}$			100	nA
$V_{GS(th)}$	Gate threshold voltage	$V_{DS} = V_{GS}$ , $I_D = 250\ \mu\text{A}$	2		4	V
$R_{DS(on)}$	Static drain-source on resistance	$V_{GS} = 10\text{ V}$ , $I_D = 30\text{ A}$		0.015	0.0195	$\Omega$

**Table 5. Dynamic**

Symbol	Parameter	Test conditions	Min.	Typ.	Max.	Unit
$C_{iss}$	Input capacitance	$V_{DS} = 25\text{ V}$ , $f = 1\text{ MHz}$ , $V_{GS} = 0$	-	5800		pF
$C_{oss}$	Output capacitance			300	-	pF
$C_{rss}$	Reverse transfer capacitance			190		pF
$Q_g$	Total gate charge	$V_{DD} = 80\text{ V}$ , $I_D = 65\text{ A}$ , $V_{GS} = 10\text{ V}$ (see Figure 16)	-	85		nC
$Q_{gs}$	Gate-source charge			20	-	nC
$Q_{gd}$	Gate-drain charge			25		nC

**Table 6. Switching times**

Symbol	Parameter	Test conditions	Min.	Typ.	Max.	Unit
$t_{d(on)}$	Turn-on delay time	$V_{DD} = 50\text{ V}$ , $I_D = 30\text{ A}$ , $R_G = 4.7\ \Omega$ , $V_{GS} = 10\text{ V}$ (see Figure 15)	-	30		ns
$t_r$	Rise time			20	-	ns
$t_{d(off)}$	Turn-off-delay time	$V_{DD} = 50\text{ V}$ , $I_D = 30\text{ A}$ , $R_G = 4.7\ \Omega$ , $V_{GS} = 10\text{ V}$ (see Figure 15)	-	65		ns
$t_f$	Fall time			20	-	ns

Table 7. Source drain diode

Symbol	Parameter	Test conditions	Min.	Typ.	Max	Unit
$I_{SD}$	Source-drain current		-		60	A
$I_{SDM}^{(1)}$	Source-drain current (pulsed)		-		240	A
$V_{SD}^{(2)}$	Forward on voltage	$I_{SD} = 60 \text{ A}$ , $V_{GS} = 0$	-		1.5	V
$t_{rr}$	Reverse recovery time	$I_{SD} = 60 \text{ A}$ , $V_{DD} = 25 \text{ V}$ $di/dt = 100 \text{ A}/\mu\text{s}$ , $T_j = 150 \text{ }^\circ\text{C}$ <i>(see Figure 17)</i>	-	80		ns
$Q_{rr}$	Reverse recovery charge			280		nC
$I_{RRM}$	Reverse recovery current			6.7		A

1. Pulse width limited by safe operating area.

2. Pulsed: Pulse duration = 300  $\mu\text{s}$ , duty cycle 1.5%

## 2.1 Electrical characteristics (curves)

**Figure 2. Safe operating area for TO-220, TO-247, D<sup>2</sup>PAK**

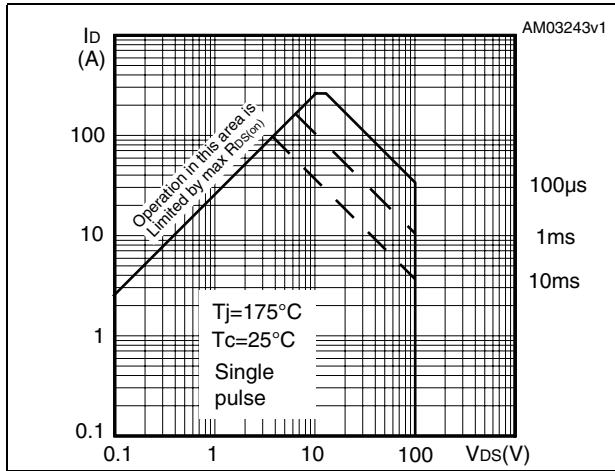

**Figure 3. Thermal impedance for TO-220, TO-247, D<sup>2</sup>PAK**

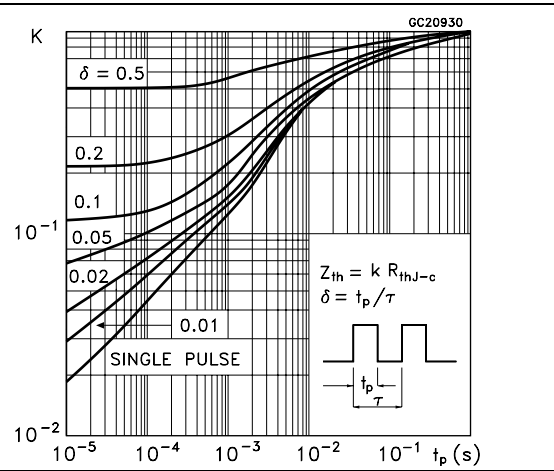

**Figure 4. Safe operating area for DPAK**

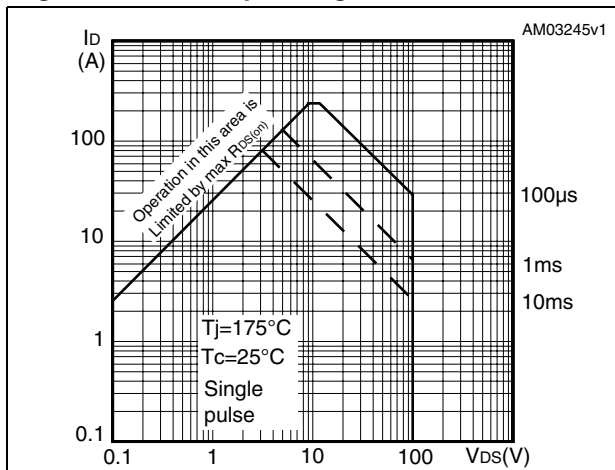

**Figure 5. Thermal impedance for DPAK**

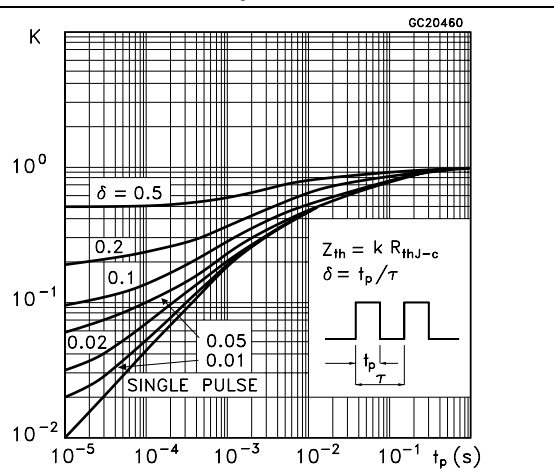

**Figure 6. Output characteristics**

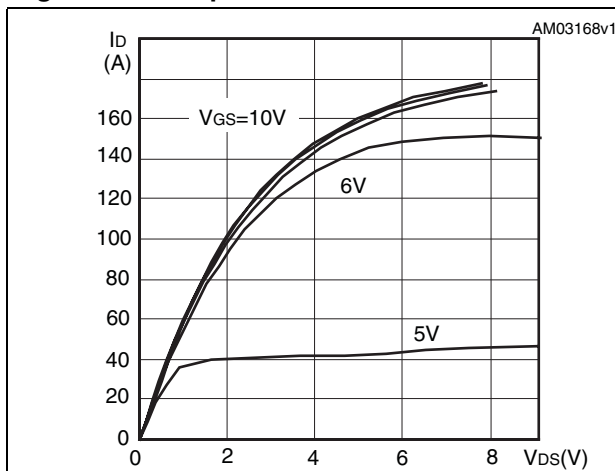

**Figure 7. Transfer characteristics**

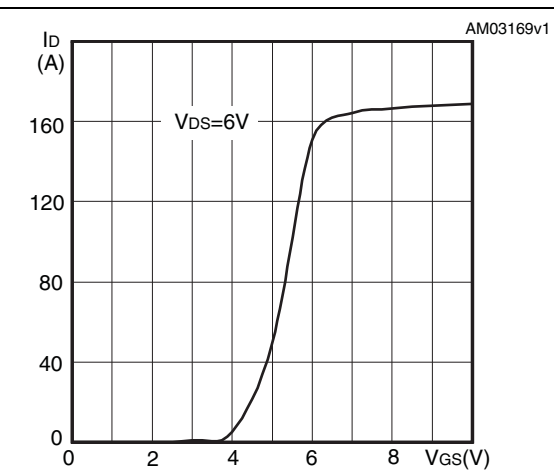

Figure 8. Normalized  $B_{VDSS}$  vs temperature

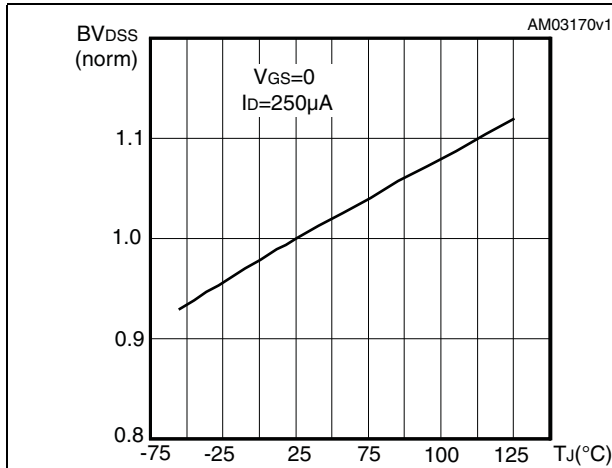

Figure 9. Static drain-source on resistance

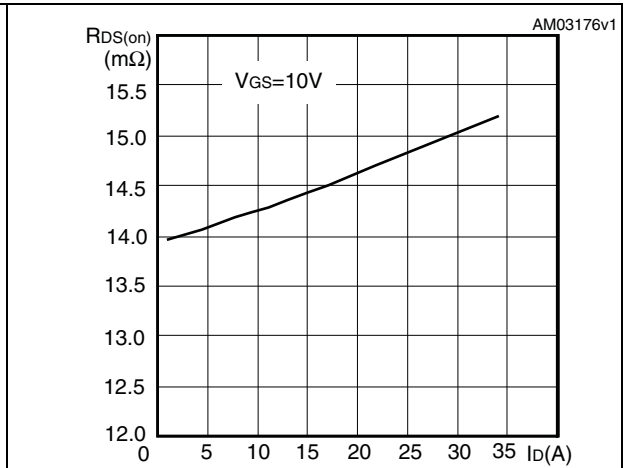

Figure 10. Gate charge vs gate-source voltage

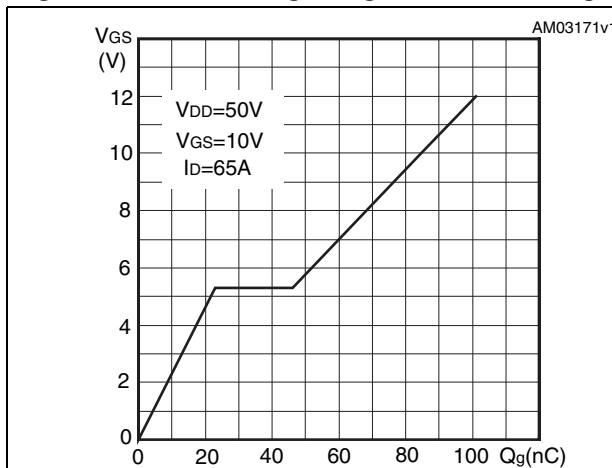

Figure 11. Capacitance variations

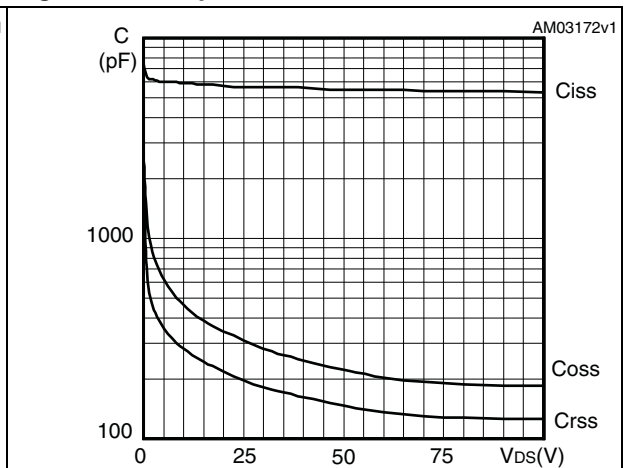

Figure 12. Normalized gate threshold voltage vs temperature

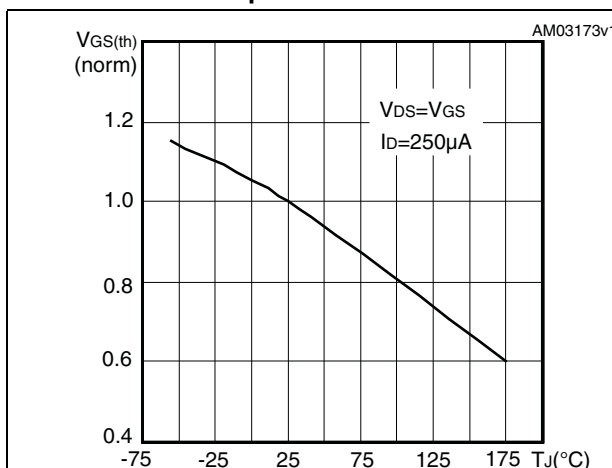

Figure 13. Normalized on resistance vs temperature

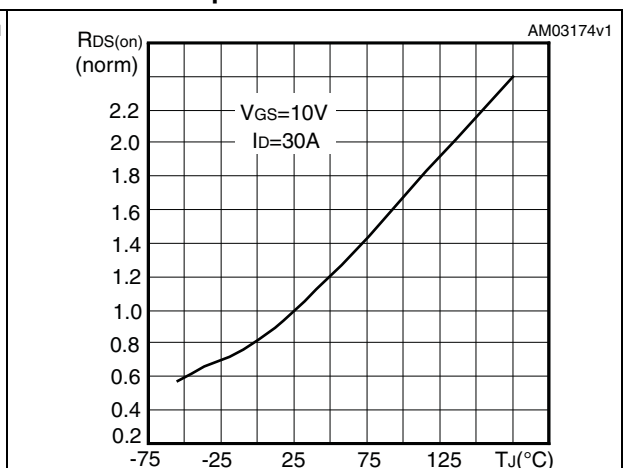
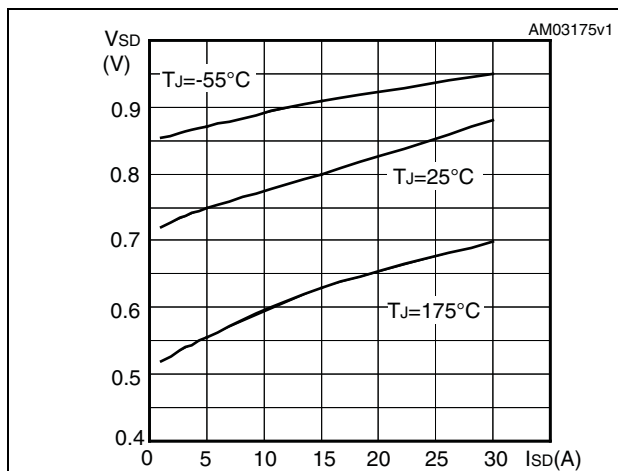

Figure 14. Source-drain diode forward characteristics







## 4 Package mechanical data

In order to meet environmental requirements, ST offers these devices in different grades of ECOPACK<sup>®</sup> packages, depending on their level of environmental compliance. ECOPACK<sup>®</sup> specifications, grade definitions and product status are available at: [www.st.com](http://www.st.com). ECOPACK is an ST trademark.

TO-220 type A mechanical data

Dim	mm		
	Min	Typ	Max
A	4.40		4.60
b	0.61		0.88
b1	1.14		1.70
c	0.48		0.70
D	15.25		15.75
D1		1.27	
E	10		10.40
e	2.40		2.70
e1	4.95		5.15
F	1.23		1.32
H1	6.20		6.60
J1	2.40		2.72
L	13		14
L1	3.50		3.93
L20		16.40	
L30		28.90	
∅P	3.75		3.85
Q	2.65		2.95

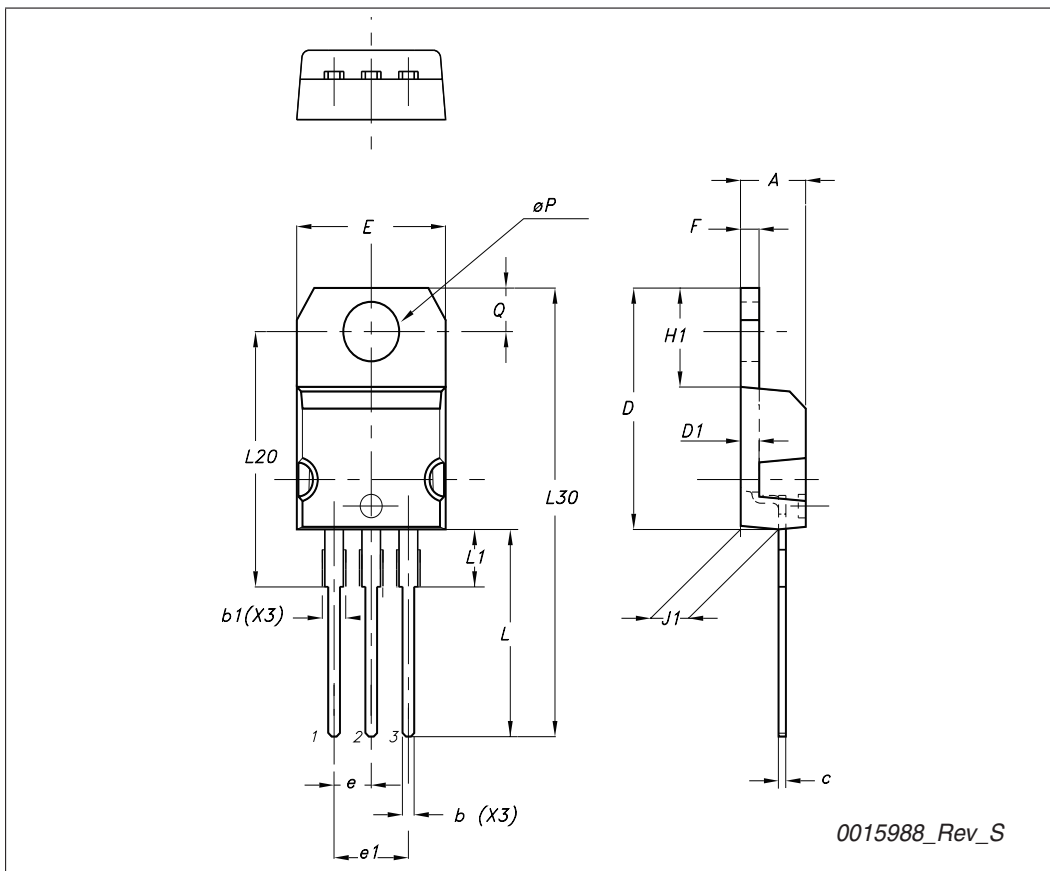

**TO-252 (DPAK) mechanical data**

DIM.	mm.		
	min.	typ	max.
A	2.20		2.40
A1	0.90		1.10
A2	0.03		0.23
b	0.64		0.90
b4	5.20		5.40
c	0.45		0.60
c2	0.48		0.60
D	6.00		6.20
D1		5.10	
E	6.40		6.60
E1		4.70	
e		2.28	
e1	4.40		4.60
H	9.35		10.10
L	1		
L1		2.80	
L2		0.80	
L4	0.60		1
R		0.20	
V2	0°		8°

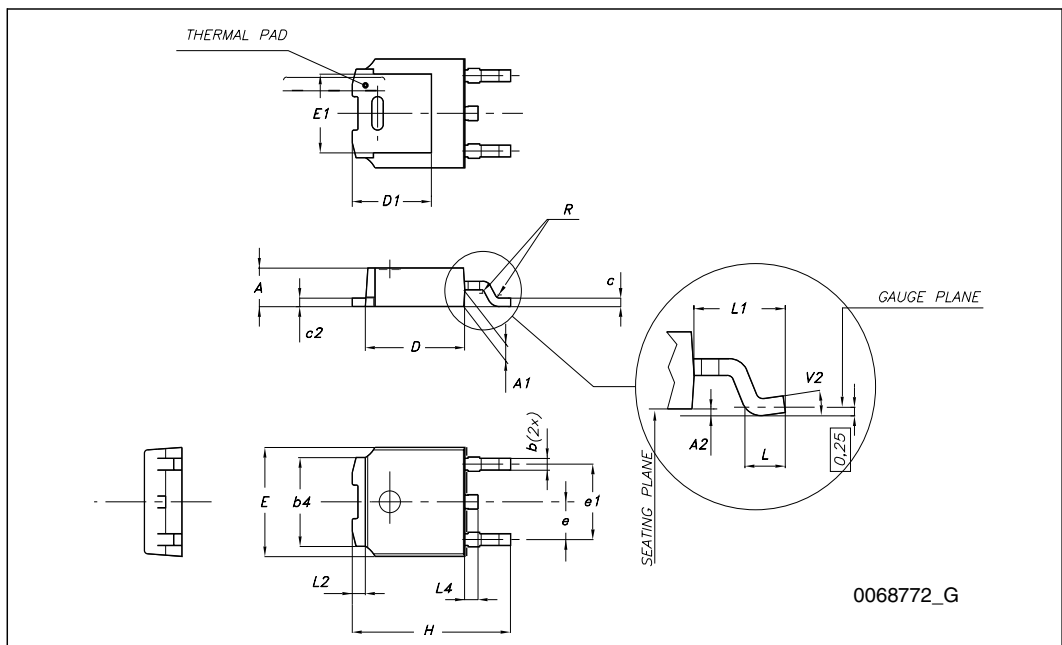

**TO-247 Mechanical data**

Dim.	mm.		
	Min.	Typ	Max.
A	4.85		5.15
A1	2.20		2.60
b	1.0		1.40
b1	2.0		2.40
b2	3.0		3.40
c	0.40		0.80
D	19.85		20.15
E	15.45		15.75
e		5.45	
L	14.20		14.80
L1	3.70		4.30
L2		18.50	
øP	3.55		3.65
øR	4.50		5.50
S		5.50	

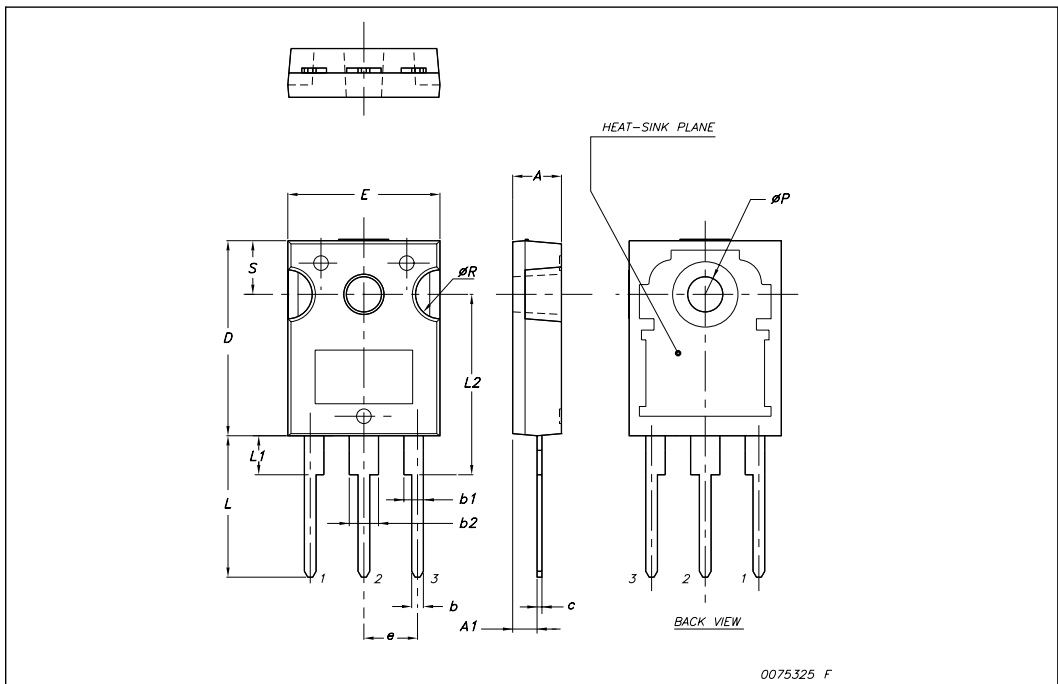

D<sup>2</sup>PAK (TO-263) mechanical data

Dim	mm			inch		
	Min	Typ	Max	Min	Typ	Max
A	4.40		4.60	0.173		0.181
A1	0.03		0.23	0.001		0.009
b	0.70		0.93	0.027		0.037
b2	1.14		1.70	0.045		0.067
c	0.45		0.60	0.017		0.024
c2	1.23		1.36	0.048		0.053
D	8.95		9.35	0.352		0.368
D1	7.50			0.295		
E	10		10.40	0.394		0.409
E1	8.50			0.334		
e		2.54			0.1	
e1	4.88		5.28	0.192		0.208
H	15		15.85	0.590		0.624
J1	2.49		2.69	0.099		0.106
L	2.29		2.79	0.090		0.110
L1	1.27		1.40	0.05		0.055
L2	1.30		1.75	0.051		0.069
R		0.4			0.016	
V2	0°		8°	0°		8°

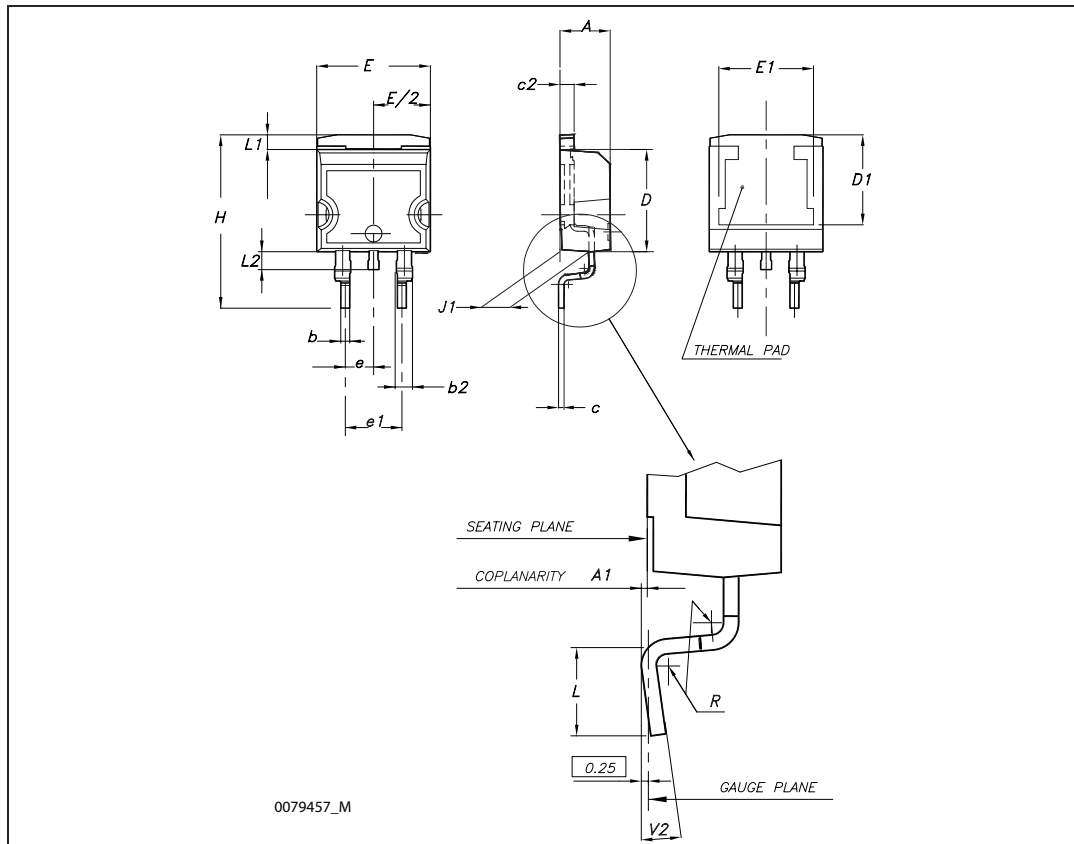

# 5 Packaging mechanical data

## DPAK FOOTPRINT

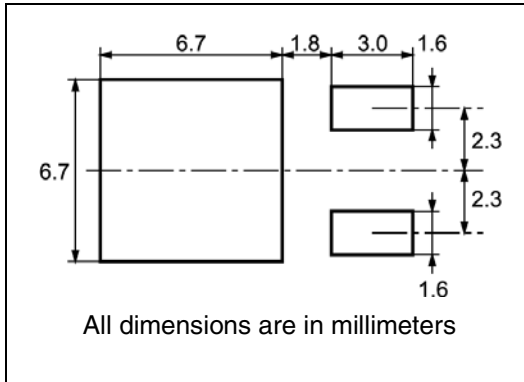

## TAPE AND REEL SHIPMENT

40 mm min. Access hole at slot location

Full radius

Tape slot in core for tape start 2.5mm min. width

G measured at hub

DIM.	mm		inch	
	MIN.	MAX.	MIN.	MAX.
A		330		12.992
B	1.5		0.059	
C	12.8	13.2	0.504	0.520
D	20.2		0.795	
G	16.4	18.4	0.645	0.724
N	50		1.968	
T		22.4		0.881

BASE QTY		BULK QTY	
2500		2500	

DIM.	mm		inch	
	MIN.	MAX.	MIN.	MAX.
A0	6.8	7	0.267	0.275
B0	10.4	10.6	0.409	0.417
B1		12.1		0.476
D	1.5	1.6	0.059	0.063
D1	1.5		0.059	
E	1.65	1.85	0.065	0.073
F	7.4	7.6	0.291	0.299
K0	2.55	2.75	0.100	0.108
P0	3.9	4.1	0.153	0.161
P1	7.9	8.1	0.311	0.319
P2	1.9	2.1	0.075	0.082
R	40		1.574	
W	15.7	16.3	0.618	0.641

10 pitches cumulative tolerance on tape +/- 0.2 mm

Center line of cavity

For machine ref. only including draft and radii concentric around B0

TRL

Bending radius R min.

FEED DIRECTION

D<sup>2</sup>PAK FOOTPRINT

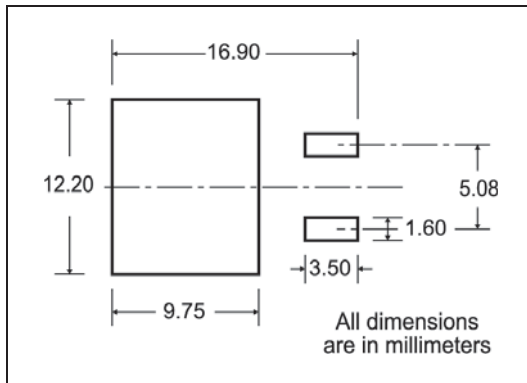

TAPE AND REEL SHIPMENT

**TAPE MECHANICAL DATA**

DIM.	mm		inch	
	MIN.	MAX.	MIN.	MAX.
A0	10.5	10.7	0.413	0.421
B0	15.7	15.9	0.618	0.626
D	1.5	1.6	0.059	0.063
D1	1.59	1.61	0.062	0.063
E	1.65	1.85	0.065	0.073
F	11.4	11.6	0.449	0.456
K0	4.8	5.0	0.189	0.197
P0	3.9	4.1	0.153	0.161
P1	11.9	12.1	0.468	0.476
P2	1.9	2.1	0.075	0.082
R	50		1.574	
T	0.25	0.35	0.0098	0.0137
W	23.7	24.3	0.933	0.956

**REEL MECHANICAL DATA**

DIM.	mm		inch	
	MIN.	MAX.	MIN.	MAX.
A		330		12.992
B	1.5		0.059	
C	12.8	13.2	0.504	0.520
D	20.2		0.795	
G	24.4	26.4	0.960	1.039
N	100		3.937	
T		30.4		1.197

BASE QTY	BULK QTY
1000	1000



## 6 Revision history

**Table 8. Document revision history**

<b>Date</b>	<b>Revision</b>	<b>Changes</b>
12-Nov-2008	1	First release
14-Jan-2009	2	Added new package, mechanical data DPAK
09-Oct-2009	3	Added new package, mechanical data D <sup>2</sup> PAK

**Please Read Carefully:**

Information in this document is provided solely in connection with ST products. STMicroelectronics NV and its subsidiaries ("ST") reserve the right to make changes, corrections, modifications or improvements, to this document, and the products and services described herein at any time, without notice.

All ST products are sold pursuant to ST's terms and conditions of sale.

Purchasers are solely responsible for the choice, selection and use of the ST products and services described herein, and ST assumes no liability whatsoever relating to the choice, selection or use of the ST products and services described herein.

No license, express or implied, by estoppel or otherwise, to any intellectual property rights is granted under this document. If any part of this document refers to any third party products or services it shall not be deemed a license grant by ST for the use of such third party products or services, or any intellectual property contained therein or considered as a warranty covering the use in any manner whatsoever of such third party products or services or any intellectual property contained therein.

**UNLESS OTHERWISE SET FORTH IN ST'S TERMS AND CONDITIONS OF SALE ST DISCLAIMS ANY EXPRESS OR IMPLIED WARRANTY WITH RESPECT TO THE USE AND/OR SALE OF ST PRODUCTS INCLUDING WITHOUT LIMITATION IMPLIED WARRANTIES OF MERCHANTABILITY, FITNESS FOR A PARTICULAR PURPOSE (AND THEIR EQUIVALENTS UNDER THE LAWS OF ANY JURISDICTION), OR INFRINGEMENT OF ANY PATENT, COPYRIGHT OR OTHER INTELLECTUAL PROPERTY RIGHT.**

**UNLESS EXPRESSLY APPROVED IN WRITING BY AN AUTHORIZED ST REPRESENTATIVE, ST PRODUCTS ARE NOT RECOMMENDED, AUTHORIZED OR WARRANTED FOR USE IN MILITARY, AIR CRAFT, SPACE, LIFE SAVING, OR LIFE SUSTAINING APPLICATIONS, NOR IN PRODUCTS OR SYSTEMS WHERE FAILURE OR MALFUNCTION MAY RESULT IN PERSONAL INJURY, DEATH, OR SEVERE PROPERTY OR ENVIRONMENTAL DAMAGE. ST PRODUCTS WHICH ARE NOT SPECIFIED AS "AUTOMOTIVE GRADE" MAY ONLY BE USED IN AUTOMOTIVE APPLICATIONS AT USER'S OWN RISK.**

Resale of ST products with provisions different from the statements and/or technical features set forth in this document shall immediately void any warranty granted by ST for the ST product or service described herein and shall not create or extend in any manner whatsoever, any liability of ST.

ST and the ST logo are trademarks or registered trademarks of ST in various countries.

Information in this document supersedes and replaces all information previously supplied.

The ST logo is a registered trademark of STMicroelectronics. All other names are the property of their respective owners.

© 2009 STMicroelectronics - All rights reserved

STMicroelectronics group of companies

Australia - Belgium - Brazil - Canada - China - Czech Republic - Finland - France - Germany - Hong Kong - India - Israel - Italy - Japan - Malaysia - Malta - Morocco - Philippines - Singapore - Spain - Sweden - Switzerland - United Kingdom - United States of America

[www.st.com](http://www.st.com)

# Mouser Electronics

Authorized Distributor

Click to View Pricing, Inventory, Delivery & Lifecycle Information:

[STMicroelectronics:](#)

[STD70N10F4](#)