



Features

- Compatible with all I²C bus modes:
 - 1 MHz
 - 400 kHz
 - 100 kHz
- Memory array:
 - 64 Kbit (8 Kbyte) of EEPROM
 - Page size: 32 byte
 - Additional Write lockable page (M24C64-D order codes)
- Single supply voltage:
 - 1.7 V to 5.5 V over -40 °C / +85 °C
 - 1.6 V to 5.5 V over 0 °C / +85 °C
- Write:
 - Byte Write within 5 ms
 - Page Write within 5 ms
- Random and sequential Read modes
- Write protect of the whole memory array
- Enhanced ESD/Latch-Up protection
- More than 4 million Write cycles
- More than 200-years data retention

Packages

- PDIP8 ECOPACK2[®]
- SO8 ECOPACK2[®]
- TSSOP8 ECOPACK2[®]
- UFDFPN ECOPACK2[®]
- WLCSP ECOPACK2[®]
- Unsawn wafer (each die is tested)

Contents

1	Description	6
2	Signal description	9
2.1	Serial Clock (SCL)	9
2.2	Serial Data (SDA)	9
2.3	Chip Enable (E2, E1, E0)	9
2.4	Write Control (\overline{WC})	9
2.5	V _{SS} (ground)	10
2.6	Supply voltage (V _{CC})	10
2.6.1	Operating supply voltage (V _{CC})	10
2.6.2	Power-up conditions	10
2.6.3	Device reset	10
2.6.4	Power-down conditions	10
3	Memory organization	11
4	Device operation	12
4.1	Start condition	13
4.2	Stop condition	13
4.3	Data input	13
4.4	Acknowledge bit (ACK)	13
4.5	Device addressing	14
5	Instructions	15
5.1	Write operations	15
5.1.1	Byte Write	16
5.1.2	Page Write	17
5.1.3	Write Identification Page (M24C64-D only)	18
5.1.4	Lock Identification Page (M24C64-D only)	18
5.1.5	ECC (Error Correction Code) and Write cycling	18
5.1.6	Minimizing Write delays by polling on ACK	19
5.2	Read operations	20
5.2.1	Random Address Read	21

5.2.2	Current Address Read	21
5.2.3	Sequential Read	21
5.3	Read Identification Page (M24C64-D only)	21
5.4	Read the lock status (M24C64-D only)	22
6	Initial delivery state	23
7	Maximum rating	24
8	DC and AC parameters	25
9	Package information	34
9.1	UFDFPN5 (DFN5) package information	34
9.2	UFDFPN8 (DFN8) package information	36
9.3	TSSOP8 package information	37
9.4	SO8N package information	38
9.5	PDIP8 package information	40
9.6	WLCSP4 ultra thin package information	41
9.7	WLCSP5 package information	43
9.8	WLCSP8 thin package information	45
10	Ordering information	47
11	Revision history	50

List of tables

Table 1.	Signal names	6
Table 2.	WLCSP 4-bump signals vs. bump position	7
Table 3.	WLCSP 5-bump signals vs. bump position	8
Table 4.	WLCSP 8-bump signals vs bump position	8
Table 5.	Device select code	14
Table 6.	Most significant address byte	15
Table 7.	Least significant address byte	15
Table 8.	Absolute maximum ratings	24
Table 9.	Operating conditions (voltage range W)	25
Table 10.	Operating conditions (voltage range R)	25
Table 11.	Operating conditions (voltage range F)	25
Table 12.	AC measurement conditions	25
Table 13.	Input parameters	26
Table 14.	Cycling performance	26
Table 15.	Memory cell data retention	26
Table 16.	DC characteristics (M24C64-W, device grade 6)	27
Table 17.	DC characteristics (M24C64-R device grade 6)	28
Table 18.	DC characteristics (M24C64-F, M24C64-DF, device grade 6)	29
Table 19.	400 kHz AC characteristics	30
Table 20.	1 MHz AC characteristics	31
Table 21.	UFDFPN5 - 1.7 × 1.4 mm, 0.55 mm thickness, ultra thin fine pitch dual flat package, no lead - package mechanical data	34
Table 22.	UFDFPN8 – 2x3 mm, 0.55 thickness, ultra thin fine pitch dual flat package, no lead - package mechanical data	36
Table 23.	TSSOP8 – 3 x 4.4 mm, 0.65 mm pitch, 8-lead thin shrink small outline, package mechanical data	37
Table 24.	SO8N – 3.9x4.9 mm, 8-lead plastic small outline, 150 mils body width, package mechanical data	38
Table 25.	PDIP8 – 8-pin plastic DIP, 0.25 mm lead frame, package mechanical data	40
Table 26.	Ultra Thin WLCSP- 4-bump, 0.795 x 0.674 mm, wafer level chip scale package mechanical data	41
Table 27.	WLCSP- 5-bump, 0.959 x 1.073 mm, 0.4 mm pitch wafer level chip scale package mechanical data	44
Table 28.	Thin WLCSP- 8-bump, 1.073 x 0.959 mm, wafer level chip scale package mechanical data	46
Table 29.	Ordering information scheme	47
Table 30.	Ordering information scheme (unsawn wafer)	48
Table 31.	Document revision history	50

List of figures

Figure 1.	Logic diagram	6
Figure 2.	8-pin package connections, top view	6
Figure 3.	UFDFPN5 (DFN5) package connections	7
Figure 4.	WLCSP 4 bump ultra thin package connections	7
Figure 5.	WLCSP 5-bump connections (M24C64-FCS6TP/K)	7
Figure 6.	WLCSP 8-bump thin connections (M24C64-DFCT6TP/K)	8
Figure 7.	Chip enable inputs connection	9
Figure 8.	Block diagram	11
Figure 9.	I ² C bus protocol	12
Figure 10.	Write mode sequences with $\overline{WC} = 0$ (data write enabled)	16
Figure 11.	Write mode sequences with $\overline{WC} = 1$ (data write inhibited)	17
Figure 12.	Write cycle polling flowchart using ACK	19
Figure 13.	Read mode sequences	20
Figure 14.	AC measurement I/O waveform	26
Figure 15.	Maximum R _{bus} value versus bus parasitic capacitance (C _{bus}) for an I ² C bus at maximum frequency f _C = 400 kHz	32
Figure 16.	Maximum R _{bus} value versus bus parasitic capacitance C _{bus}) for an I ² C bus at maximum frequency f _C = 1MHz	32
Figure 17.	AC waveforms	33
Figure 18.	UFDFPN5 – 1.7x1.4 mm, 0.55 mm thickness, ultra thin fine pitch dual flat package, no lead - package outline	34
Figure 19.	UFDFPN5 - 5-lead, 1.7 × 1.4 mm, 0.55 mm thickness, ultra thin fine pitch dual flat package, no lead recommended footprint	35
Figure 20.	UFDFPN8 – 2x3 mm, 0.55 thickness, ultra thin fine pitch dual flat package, no lead - package outline	36
Figure 21.	TSSOP8 – 3x4.4 mm, 0.65 mm pitch, 8-lead thin shrink small outline, package outline	37
Figure 22.	SO8N – 3.9x4.9 mm, 8-lead plastic small outline, 150 mils body width, package outline	38
Figure 23.	SO8N – 3.9x4.9 mm, 8-lead plastic small outline, 150 mils body width, package recommended footprint	39
Figure 24.	PDIP8 – 8-pin plastic DIP, 0.25 mm lead frame, package outline	40
Figure 25.	Ultra Thin WLCSP- 4-bump, 0.795 x 0.674 mm, wafer level chip scale package outline	41
Figure 26.	Thin WLCSP- 4-bump, 0.795 x 0.674 mm, wafer level chip scale package recommended footprint	42
Figure 27.	WLCSP 5-bump, 0.959 x 1.073 mm, 0.4 mm pitch wafer level chip scale (M24C64-FCS6TP/K)- package outline	43
Figure 28.	WLCSP - 5-bump, 0.959 x 1.073 mm, 0.4 mm pitch wafer level chip scale recommended footprint	44
Figure 29.	Thin WLCSP- 8-bump, 1.073 x 0.959 mm, wafer level chip scale package outline	45
Figure 30.	Thin WLCSP- 8-bump, 1.073 x 0.959 mm, wafer level chip scale package recommended footprint	46

1 Description

The M24C64 is a 64-Kbit I²C-compatible EEPROM (Electrically Erasable PROgrammable Memory) organized as 8 K × 8 bits.

Over an ambient temperature range of -40 °C / +85 °C, the M24C64-W can operate with a supply voltage from 2.5 V to 5.5 V, the M24C64-R can operate with a supply voltage from 1.8 V to 5.5 V, and the M24C64-F and M24C64-DF can operate with a supply voltage from 1.7 V to 5.5 V (the M24C64-F can also operate down to 1.6 V, under some restricting conditions).

The M24C64-D offers an additional page, named the Identification Page (32 byte). The Identification Page can be used to store sensitive application parameters which can be (later) permanently locked in Read-only mode.

Figure 1. Logic diagram



AI01844f

Table 1. Signal names

Signal name	Function	Direction
E2, E1, E0	Chip Enable	Input
SDA	Serial Data	I/O
SCL	Serial Clock	Input
\overline{WC}	Write Control	Input
V _{CC}	Supply voltage	-
V _{SS}	Ground	-

Figure 2. 8-pin package connections, top view

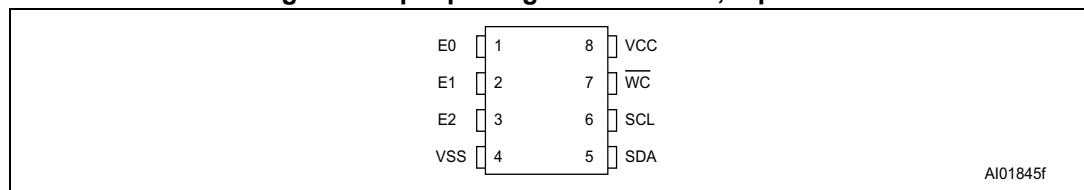

AI01845f

1. See [Section 9: Package information](#) for package dimensions, and how to identify pin 1

Figure 3. UDFPN5 (DFN5) package connections



- Inputs E2, E1, E0 are not connected, therefore read as (000). Please refer to [Section 2.3](#) for further explanations.

Figure 4. WLCSP 4 bump ultra thin package connections



- Inputs E2, E1, E0 are read as (000). Please refer to [Section 2.3](#) for further explanations.

Table 2. WLCSP 4-bump signals vs. bump position

Position	A	B
1	V _{CC}	SCL
2	V _{SS}	SDA

Figure 5. WLCSP 5-bump connections (M24C64-FCS6TP/K)

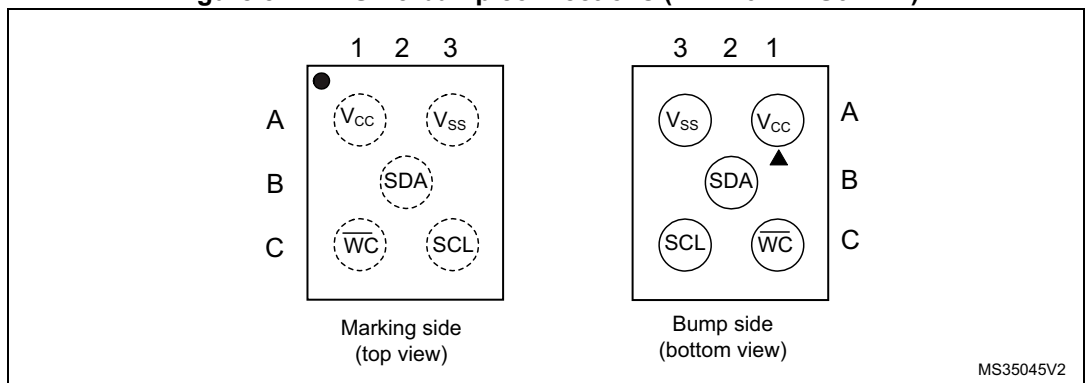

- Inputs E2, E1, E0 are internally connected to (001). Please refer to [Section 2.3](#) for further explanations.

Table 3. WLCSP 5-bump signals vs. bump position

Position	A	B	C
1	V _{CC}	-	\overline{WC}
2	-	SDA	-
3	V _{SS}	-	SCL

Figure 6. WLCSP 8-bump thin connections (M24C64-DFCT6TP/K)

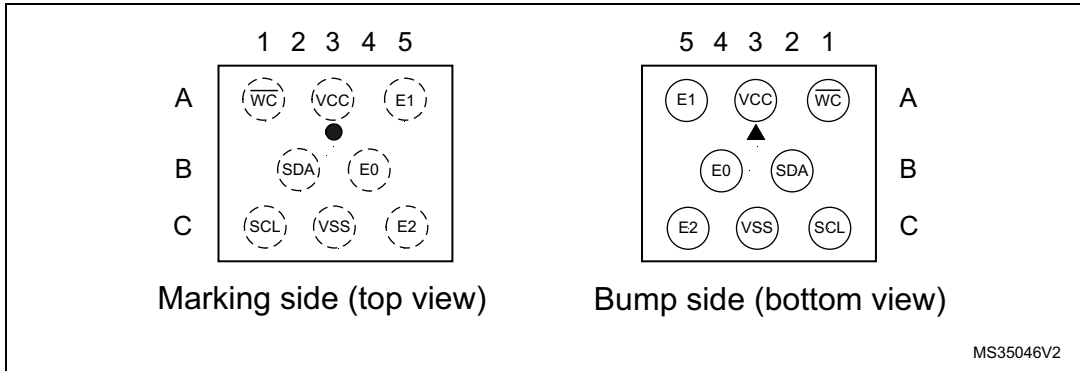

Table 4. WLCSP 8-bump signals vs bump position

Position	A	B	C
1	\overline{WC}	-	SCL
2	-	SDA	-
3	V _{CC}	-	V _{SS}
4	-	E0	-
5	E1	-	E2

2 Signal description

2.1 Serial Clock (SCL)

The signal applied on the SCL input is used to strobe the data available on SDA(in) and to output the data on SDA(out).

2.2 Serial Data (SDA)

SDA is an input/output used to transfer data in or data out of the device. SDA(out) is an open drain output that may be wire-OR'ed with other open drain or open collector signals on the bus. A pull-up resistor must be connected from Serial Data (SDA) to V_{CC} (Figure 15 indicates how to calculate the value of the pull-up resistor).

2.3 Chip Enable (E2, E1, E0)

(E2,E1,E0) input signals are used to set the value that is to be looked for on the three least significant bits (b3, b2, b1) of the 7-bit device select code (see Table 5). These inputs must be tied to V_{CC} or V_{SS} , as shown in Figure 7. When not connected (left floating), these inputs are read as low (0).

For the 4-balls WLCSP package (see Figure 4), the (E2,E1,E0) inputs are internally connected to (0, 0, 0).

For the 5-balls WLCSP package (see Figure 5), the (E2,E1,E0) inputs are internally connected to (0,0,1).

Figure 7. Chip enable inputs connection

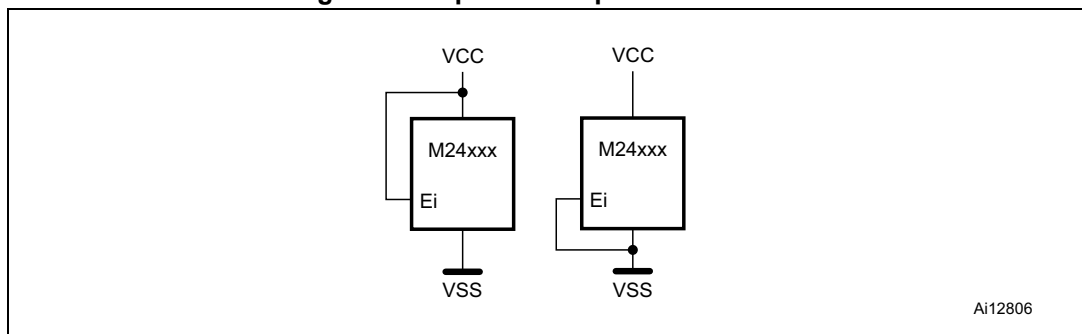

2.4 Write Control (\overline{WC})

This input signal is useful for protecting the entire contents of the memory from inadvertent write operations. Write operations are disabled to the entire memory array when Write Control (\overline{WC}) is driven high. Write operations are enabled when Write Control (\overline{WC}) is either driven low or left floating.

When Write Control (\overline{WC}) is driven high, device select and address bytes are acknowledged, Data bytes are not acknowledged.

2.5 V_{SS} (ground)

V_{SS} is the reference for the V_{CC} supply voltage.

2.6 Supply voltage (V_{CC})

2.6.1 Operating supply voltage (V_{CC})

Prior to selecting the memory and issuing instructions to it, a valid and stable V_{CC} voltage within the specified [$V_{CC}(\min)$, $V_{CC}(\max)$] range must be applied (see Operating conditions in [Section 8: DC and AC parameters](#)). In order to secure a stable DC supply voltage, it is recommended to decouple the V_{CC} line with a suitable capacitor (usually of the order of 10 nF to 100 nF) close to the V_{CC}/V_{SS} package pins.

This voltage must remain stable and valid until the end of the transmission of the instruction and, for a write instruction, until the completion of the internal write cycle (t_W).

2.6.2 Power-up conditions

The V_{CC} voltage has to rise continuously from 0 V up to the minimum V_{CC} operating voltage (see Operating conditions in [Section 8: DC and AC parameters](#)).

2.6.3 Device reset

In order to prevent inadvertent write operations during power-up, a power-on-reset (POR) circuit is included.

At power-up, the device does not respond to any instruction until V_{CC} has reached the internal reset threshold voltage. This threshold is lower than the minimum V_{CC} operating voltage (see Operating conditions in [Section 8: DC and AC parameters](#)). When V_{CC} passes over the POR threshold, the device is reset and enters the Standby Power mode; however, the device must not be accessed until V_{CC} reaches a valid and stable DC voltage within the specified [$V_{CC}(\min)$, $V_{CC}(\max)$] range (see Operating conditions in [Section 8: DC and AC parameters](#)).

In a similar way, during power-down (continuous decrease in V_{CC}), the device must not be accessed when V_{CC} drops below $V_{CC}(\min)$. When V_{CC} drops below the power-on-reset threshold voltage, the device stops responding to any instruction sent to it.

2.6.4 Power-down conditions

During power-down (continuous decrease in V_{CC}), the device must be in the Standby Power mode (mode reached after decoding a Stop condition, assuming that there is no internal write cycle in progress).

3 Memory organization

The memory is organized as shown below.

Figure 8. Block diagram



4 Device operation

The device supports the I²C protocol. This is summarized in [Figure 9](#). Any device that sends data on to the bus is defined to be a transmitter, and any device that reads the data to be a receiver. The device that controls the data transfer is known as the bus master, and the other as the slave device. A data transfer can only be initiated by the bus master, which will also provide the serial clock for synchronization. The device is always a slave in all communications.

Figure 9. I²C bus protocol

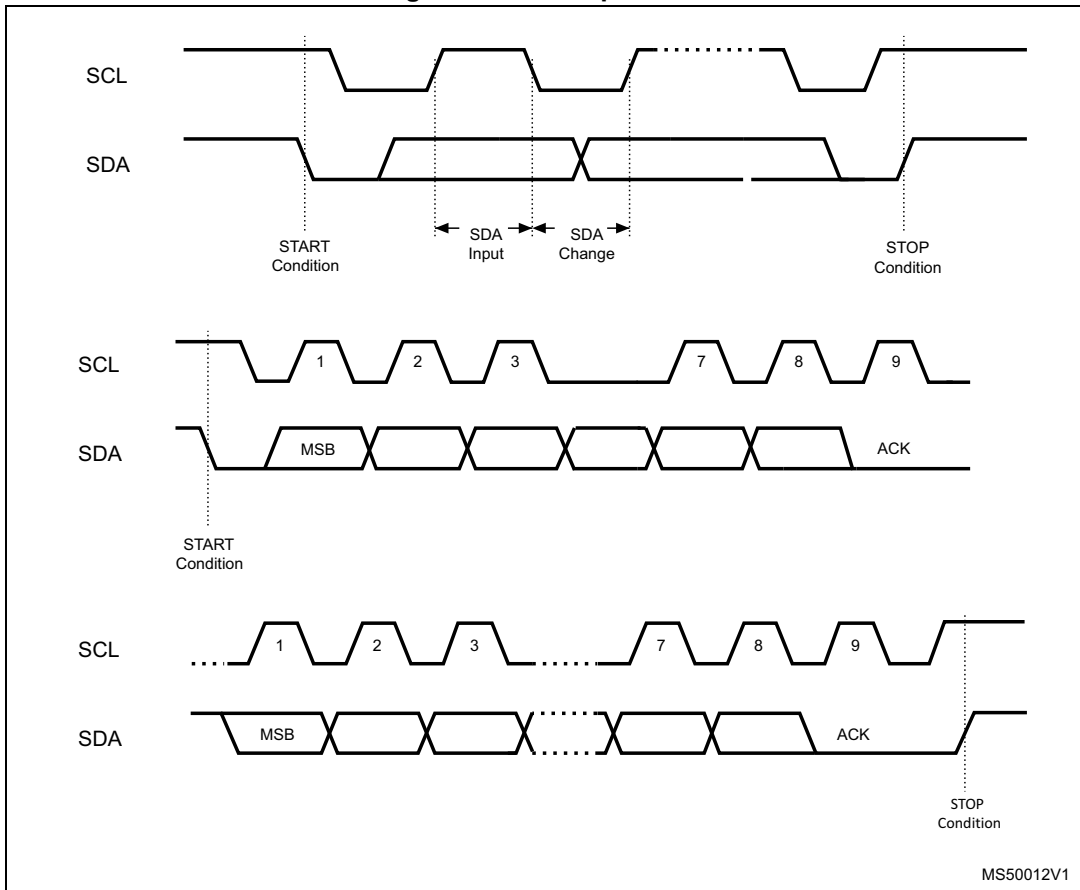

4.1 Start condition

Start is identified by a falling edge of Serial Data (SDA) while Serial Clock (SCL) is stable in the high state. A Start condition must precede any data transfer instruction. The device continuously monitors (except during a Write cycle) Serial Data (SDA) and Serial Clock (SCL) for a Start condition.

4.2 Stop condition

Stop is identified by a rising edge of Serial Data (SDA) while Serial Clock (SCL) is stable and driven high. A Stop condition terminates communication between the device and the bus master. A Read instruction that is followed by NoAck can be followed by a Stop condition to force the device into the Standby mode.

A Stop condition at the end of a Write instruction triggers the internal Write cycle.

4.3 Data input

During data input, the device samples Serial Data (SDA) on the rising edge of Serial Clock (SCL). For correct device operation, Serial Data (SDA) must be stable during the rising edge of Serial Clock (SCL), and the Serial Data (SDA) signal must change *only* when Serial Clock (SCL) is driven low.

4.4 Acknowledge bit (ACK)

The acknowledge bit is used to indicate a successful byte transfer. The bus transmitter, whether it be bus master or slave device, releases Serial Data (SDA) after sending eight bits of data. During the 9th clock pulse period, the receiver pulls Serial Data (SDA) low to acknowledge the receipt of the eight data bits.

4.5 Device addressing

To start communication between the bus master and the slave device, the bus master must initiate a Start condition. Following this, the bus master sends the device select code, shown in [Table 5](#) (most significant bit first).

Table 5. Device select code

	Device type identifier ⁽¹⁾				Chip Enable address ⁽²⁾			\overline{RW}
	b7	b6	b5	b4	b3	b2	b1	b0
Device select code when addressing the memory array	1	0	1	0	E2	E1	E0	\overline{RW}
Device select code when accessing the Identification page	1	0	1	1	E2	E1	E0	\overline{RW}

1. The most significant bit, b7, is sent first.
2. E0, E1 and E2 are compared with the value read on input pins E0, E1 and E2.

When the device select code is received, the device only responds if the Chip Enable address is the same as the value on its Chip Enable E2,E1,E0 inputs.

The 8th bit is the Read/Write bit (\overline{RW}). This bit is set to 1 for Read and 0 for Write operations.

If a match occurs on the device select code, the corresponding device gives an acknowledgment on Serial Data (SDA) during the 9th bit time. If the device does not match the device select code, the device deselects itself from the bus, and goes into Standby mode.

5 Instructions

5.1 Write operations

Following a Start condition the bus master sends a device select code with the $\overline{R/\overline{W}}$ bit (\overline{RW}) reset to 0. The device acknowledges this, as shown in [Figure 10](#), and waits for two address bytes. The device responds to each address byte with an acknowledge bit, and then waits for the data byte.

Table 6. Most significant address byte

A15	A14	A13	A12	A11	A10	A9	A8
-----	-----	-----	-----	-----	-----	----	----

Table 7. Least significant address byte

A7	A6	A5	A4	A3	A2	A1	A0
----	----	----	----	----	----	----	----

When the bus master generates a Stop condition immediately after a data byte Ack bit (in the “10th bit” time slot), either at the end of a Byte Write or a Page Write, the internal Write cycle t_W is triggered. A Stop condition at any other time slot does not trigger the internal Write cycle.

After the Stop condition and the successful completion of an internal Write cycle (t_W), the device internal address counter is automatically incremented to point to the next byte after the last modified byte.

During the internal Write cycle, Serial Data (SDA) is disabled internally, and the device does not respond to any requests.

If the Write Control input (WC) is driven High, the Write instruction is not executed and the accompanying data bytes are *not* acknowledged, as shown in [Figure 11](#).

5.1.1 Byte Write

After the device select code and the address bytes, the bus master sends one data byte. If the addressed location is Write-protected, by Write Control (\overline{WC}) being driven high, the device replies with NoAck, and the location is not modified. If, instead, the addressed location is not Write-protected, the device replies with Ack. The bus master terminates the transfer by generating a Stop condition, as shown in *Figure 10*.

Figure 10. Write mode sequences with $\overline{WC} = 0$ (data write enabled)



AI01106d

5.1.2 Page Write

The Page Write mode allows up to 32 byte to be written in a single Write cycle, provided that they are all located in the same page in the memory: that is, the most significant memory address bits, A15/A5, are the same. If more bytes are sent than will fit up to the end of the page, a “roll-over” occurs, i.e. the bytes exceeding the page end are written on the same page, from location 0.

The bus master sends from 1 to 32 byte of data, each of which is acknowledged by the device if Write Control (\overline{WC}) is low. If Write Control (\overline{WC}) is high, the contents of the addressed memory location are not modified, and each data byte is followed by a NoAck, as shown in [Figure 11](#). After each transferred byte, the internal page address counter is incremented.

The transfer is terminated by the bus master generating a Stop condition.

Figure 11. Write mode sequences with $\overline{WC} = 1$ (data write inhibited)

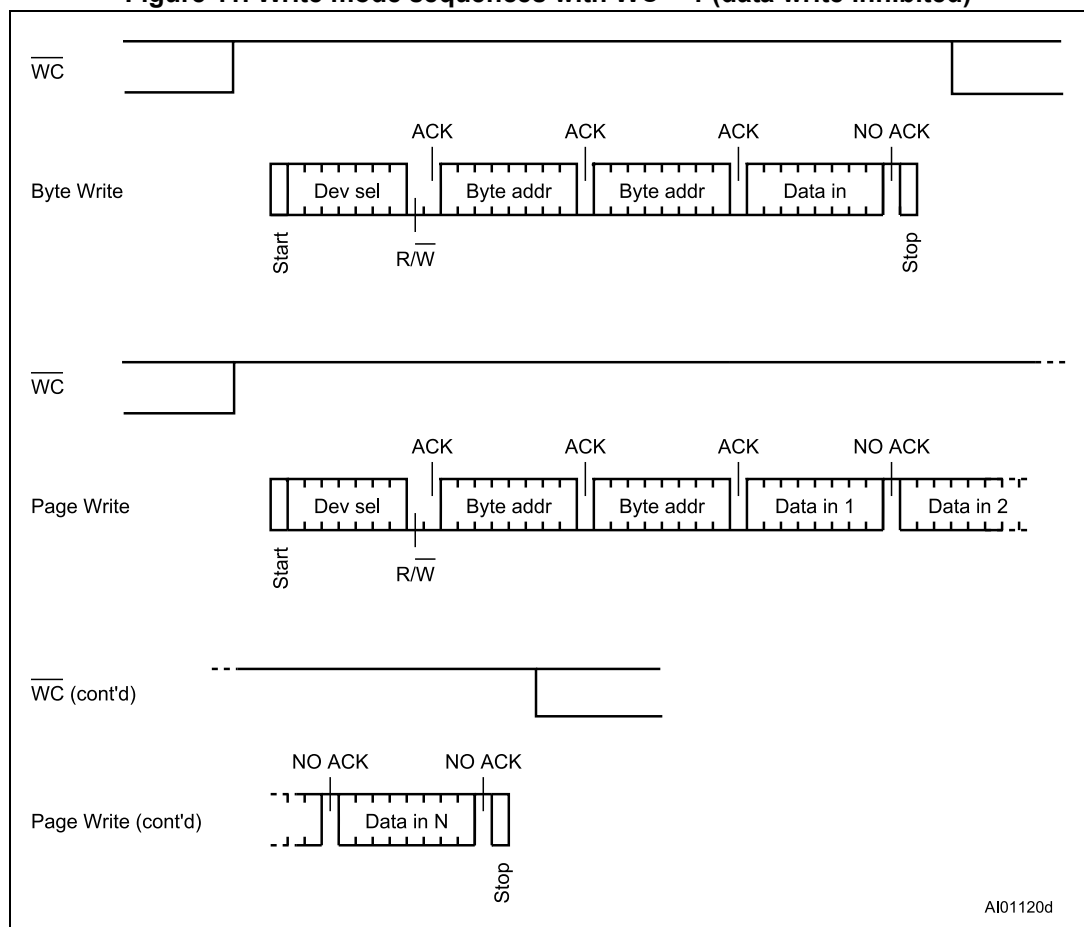

5.1.3 Write Identification Page (M24C64-D only)

The Identification Page (32 byte) is an additional page which can be written and (later) permanently locked in Read-only mode. It is written by issuing the Write Identification Page instruction. This instruction uses the same protocol and format as Page Write (into memory array), except for the following differences:

- Device type identifier = 1011b
- MSB address bits A15/A5 are don't care except for address bit A10 which must be '0'. LSB address bits A4/A0 define the byte address inside the Identification page.

If the Identification page is locked, the data bytes transferred during the Write Identification Page instruction are not acknowledged (NoAck).

5.1.4 Lock Identification Page (M24C64-D only)

The Lock Identification Page instruction (Lock ID) permanently locks the Identification page in Read-only mode. The Lock ID instruction is similar to Byte Write (into memory array) with the following specific conditions:

- Device type identifier = 1011b
- Address bit A10 must be '1'; all other address bits are don't care
- The data byte must be equal to the binary value xxxx xx1x, where x is don't care

5.1.5 ECC (Error Correction Code) and Write cycling

The ECC is offered only in devices identified with process letter K, all other devices (identified with a different process letter) do not embed the ECC logic.

The Error Correction Code (ECC) is an internal logic function which is transparent for the I²C communication protocol.

The ECC logic is implemented on each group of four EEPROM bytes^(a). Inside a group, if a single bit out of the four bytes happens to be erroneous during a Read operation, the ECC detects this bit and replaces it with the correct value. The read reliability is therefore much improved.

Even if the ECC function is performed on groups of four bytes, a single byte can be written/cycled independently. In this case, the ECC function also writes/cycles the three other bytes located in the same group^(a). As a consequence, the maximum cycling budget is defined at group level and the cycling can be distributed over the 4 bytes of the group: the sum of the cycles seen by byte0, byte1, byte2 and byte3 of the same group must remain below the maximum value defined [Table 14: Cycling performance](#).

a. A group of four bytes is located at addresses [4*N, 4*N+1, 4*N+2, 4*N+3], where N is an integer.

5.1.6 Minimizing Write delays by polling on ACK

During the internal Write cycle, the device disconnects itself from the bus, and writes a copy of the data from its internal latches to the memory cells. The maximum Write time (t_w) is shown in AC characteristics tables in [Section 8: DC and AC parameters](#), but the typical time is shorter. To make use of this, a polling sequence can be used by the bus master.

The sequence, as shown in [Figure 12](#), is:

- Initial condition: a Write cycle is in progress.
- Step 1: the bus master issues a Start condition followed by a device select code (the first byte of the new instruction).
- Step 2: if the device is busy with the internal Write cycle, no Ack will be returned and the bus master goes back to Step 1. If the device has terminated the internal Write cycle, it responds with an Ack, indicating that the device is ready to receive the second part of the instruction (the first byte of this instruction having been sent during Step 1).

Figure 12. Write cycle polling flowchart using ACK



1. The seven most significant bits of the Device Select code of a Random Read (bottom right box in the figure) must be identical to the seven most significant bits of the Device Select code of the Write (polling instruction in the figure).

5.2 Read operations

Read operations are performed independently of the state of the Write Control (\overline{WC}) signal. After the successful completion of a Read operation, the device internal address counter is incremented by one, to point to the next byte address.

For the Read instructions, after each byte read (data out), the device waits for an acknowledgment (data in) during the 9th bit time. If the bus master does not acknowledge during this 9th time, the device terminates the data transfer and switches to its Standby mode.

Figure 13. Read mode sequences



5.2.1 Random Address Read

A dummy Write is first performed to load the address into this address counter (as shown in [Figure 13](#)) but *without* sending a Stop condition. Then, the bus master sends another Start condition, and repeats the device select code, with the \overline{RW} bit set to 1. The device acknowledges this, and outputs the contents of the addressed byte. The bus master must *not* acknowledge the byte, and terminates the transfer with a Stop condition.

5.2.2 Current Address Read

For the Current Address Read operation, following a Start condition, the bus master only sends a device select code with the \overline{RW} bit set to 1. The device acknowledges this, and outputs the byte addressed by the internal address counter. The counter is then incremented. The bus master terminates the transfer with a Stop condition, as shown in [Figure 13](#), *without* acknowledging the byte.

Note that the address counter value is defined by instructions accessing either the memory or the Identification page. When accessing the Identification page, the address counter value is loaded with the byte location in the Identification page, therefore the next Current Address Read in the memory uses this new address counter value. When accessing the memory, it is safer to always use the Random Address Read instruction (this instruction loads the address counter with the byte location to read in the memory, see [Section 5.2.1](#)) instead of the Current Address Read instruction.

5.2.3 Sequential Read

This operation can be used after a Current Address Read or a Random Address Read. The bus master *does* acknowledge the data byte output, and sends additional clock pulses so that the device continues to output the next byte in sequence. To terminate the stream of bytes, the bus master must *not* acknowledge the last byte, and *must* generate a Stop condition, as shown in [Figure 13](#).

The output data comes from consecutive addresses, with the internal address counter automatically incremented after each byte output. After the last memory address, the address counter “rolls-over”, and the device continues to output data from memory address 00h.

5.3 Read Identification Page (M24C64-D only)

The Identification Page (32 bytes) is an additional page which can be written and (later) permanently locked in Read-only mode.

The Identification Page can be read by issuing an Read Identification Page instruction. This instruction uses the same protocol and format as the Random Address Read (from memory array) with device type identifier defined as 1011b. The MSB address bits A15/A5 are don't care, the LSB address bits A4/A0 define the byte address inside the Identification Page. The number of bytes to read in the ID page must not exceed the page boundary (e.g.: when reading the Identification Page from location 10d, the number of bytes should be less than or equal to 22, as the ID page boundary is 32 bytes).

5.4 Read the lock status (M24C64-D only)

The locked/unlocked status of the Identification page can be checked by transmitting a specific truncated command [Identification Page Write instruction + one data byte] to the device. The device returns an acknowledge bit if the Identification page is unlocked, otherwise a NoAck bit if the Identification page is locked.

Right after this, it is recommended to transmit to the device a Start condition followed by a Stop condition, so that:

- Start: the truncated command is not executed because the Start condition resets the device internal logic,
- Stop: the device is then set back into Standby mode by the Stop condition.

6 Initial delivery state

The device is delivered with all the memory array bits and Identification page bits set to 1 (each byte contains FFh).

When delivered in unsawn wafer, all memory bits are set to 1 (each memory byte contains FFh) except the last byte located at address 1FFFh which is written with the value 22h.

7 Maximum rating

Stressing the device outside the ratings listed in [Table 8](#) may cause permanent damage to the device. These are stress ratings only, and operation of the device at these, or any other conditions outside those indicated in the operating sections of this specification, is not implied. Exposure to absolute maximum rating conditions for extended periods may affect device reliability.

Table 8. Absolute maximum ratings

Symbol	Parameter	Min.	Max.	Unit
	Ambient operating temperature	-40	130	°C
T _{STG}	Storage temperature	-65	150	°C
T _{LEAD}	Lead temperature during soldering	see note ⁽¹⁾		°C
	PDIP-specific lead temperature during soldering	-	260 ⁽²⁾	°C
I _{OL}	DC output current (SDA = 0)	-	5	mA
V _{IO}	Input or output range	-0.50	6.5	V
V _{CC}	Supply voltage	-0.50	6.5	V
V _{ESD}	Electrostatic pulse (Human Body model) ⁽³⁾	-	3000 ⁽⁴⁾	V

1. Compliant with JEDEC Std J-STD-020D (for small body, Sn-Pb or Pb-free assembly), the ST ECOPACK2® 7191395 specification, and the European directive on Restrictions of Hazardous Substances (RoHS directive 2011/65/EU of July 2011).
2. T_{LEAD} max must not be applied for more than 10 s.
3. Positive and negative pulses applied on different combinations of pin connections, according to AEC-Q100-002 (compliant with ANSI/ESDA/JEDEC JS-001-2012 standard, C1=100 pF, R1=1500 Ω).
4. 4000 V for devices identified with process letter K and P.

8 DC and AC parameters

This section summarizes the operating and measurement conditions, and the DC and AC characteristics of the device.

Table 9. Operating conditions (voltage range W)

Symbol	Parameter	Min.	Max.	Unit
V_{CC}	Supply voltage	2.5	5.5	V
T_A	Ambient operating temperature	-40	85	°C
f_C	Operating clock frequency	-	1 ⁽¹⁾	MHz

1. 400 kHz for devices identified by process letter P.

Table 10. Operating conditions (voltage range R)

Symbol	Parameter	Min.	Max.	Unit
V_{CC}	Supply voltage	1.8	5.5	V
T_A	Ambient operating temperature	-40	85	°C
f_C	Operating clock frequency	-	1 ⁽¹⁾	MHz

1. 400 kHz for devices identified by process letter P.

Table 11. Operating conditions (voltage range F)

Symbol	Parameter	Min.		Max.	Unit
V_{CC}	Supply voltage	1.6 ⁽¹⁾	1.7	5.5	V
T_A	Ambient operating temperature: READ	-40	-40	85	°C
	Ambient operating temperature: WRITE	0	-40	85	
f_C	Operating clock frequency, $V_{CC} \geq 1.6 V^{(1)}$	-		400	kHz
	Operating clock frequency, $V_{CC} \geq 1.7 V$	-		1000	

1. Only for devices identified with process letter T

Table 12. AC measurement conditions

Symbol	Parameter	Min.	Max.	Unit
C_{bus}	Load capacitance	-	100	pF
-	SCL input rise/fall time, SDA input fall time	-	50	ns
-	Input levels	0.2 V_{CC} to 0.8 V_{CC}		V
-	Input and output timing reference levels	0.3 V_{CC} to 0.7 V_{CC}		V

Figure 14. AC measurement I/O waveform



Table 13. Input parameters

Symbol	Parameter ⁽¹⁾	Test condition	Min.	Max.	Unit
C _{IN}	Input capacitance (SDA)	-	-	8	pF
C _{IN}	Input capacitance (other pins)	-	-	6	pF
Z _L	Input impedance (E2, E1, E0, \overline{WC}) ⁽²⁾	V _{IN} < 0.3 V _{CC}	30	-	kΩ
Z _H		V _{IN} > 0.7 V _{CC}	500	-	kΩ

1. Characterized only, not tested in production.
2. input impedance when the memory is selected (after a Start condition).

Table 14. Cycling performance

Symbol	Parameter	Test condition	Max. ⁽¹⁾	Unit
Ncycle	Write cycle endurance ⁽²⁾	T _A ≤ 25 °C, V _{CC} (min) < V _{CC} < V _{CC} (max)	4,000,000	Write cycle ⁽³⁾
		T _A = 85 °C, V _{CC} (min) < V _{CC} < V _{CC} (max)	1,200,000	

1. Cycling performance for products identified by process letter K or T (previous products were specified with 1 million cycles at 25 °C)
2. The Write cycle endurance is defined by characterization and qualification. For devices embedding the ECC functionality (see [Chapter 5.1.5](#)), the write cycle endurance is defined for group of four bytes located at addresses [4*N, 4*N+1, 4*N+2, 4*N+3] where N is an integer.
3. A Write cycle is executed when either a Page Write, a Byte write, a Write Identification Page or a Lock Identification Page instruction is decoded. When using the Byte Write, the Page Write or the Write Identification Page, refer also to [Section 5.1.5: ECC \(Error Correction Code\) and Write cycling](#)

Table 15. Memory cell data retention

Parameter	Test condition	Min.	Unit
Data retention ⁽¹⁾	T _A = 55 °C	200 ⁽²⁾	Year

1. The data retention behavior is checked in production, while the data retention limit defined in this table is extracted from characterization and qualification results.
2. For products identified by process letter K or T (previous products were specified with a data retention of 40 years at 55°C).

Table 16. DC characteristics (M24C64-W, device grade 6)

Symbol	Parameter	Test conditions (in addition to those in Table 9)	Min.	Max.	Unit
I_{LI}	Input leakage current (SCL, SDA, E2, E1, E0)	$V_{IN} = V_{SS}$ or V_{CC} , device in Standby mode	-	± 2	μA
I_{LO}	Output leakage current	SDA in Hi-Z, external voltage applied on SDA: V_{SS} or V_{CC}	-	± 2	μA
I_{CC}	Supply current (Read)	$2.5 V < V_{CC} < 5.5 V$, $f_c = 400 kHz$ (rise/fall time < 50 ns)	-	2	mA
		$2.5 V < V_{CC} < 5.5 V$, $f_c = 1 MHz^{(1)}$ (rise/fall time < 50 ns)	-	2.5	mA
I_{CC0}	Supply current (Write)	During t_W , $2.5 V \leq V_{CC} \leq 5.5 V$	-	$2.5^{(2)}$	mA
I_{CC1}	Standby supply current	Device not selected ⁽³⁾ , $V_{IN} = V_{SS}$ or V_{CC} , $V_{CC} = 2.5 V$	-	2	μA
		Device not selected ⁽³⁾ , $V_{IN} = V_{SS}$ or V_{CC} , $V_{CC} = 5.5 V$	-	$3^{(4)}$	μA
V_{IL}	Input low voltage (SCL, SDA, \overline{WC} , E2, E1, E0) ⁽⁵⁾	-	-0.45	$0.3 V_{CC}$	V
V_{IH}	Input high voltage (SCL, SDA)	-	$0.7 V_{CC}$	6.5	V
	Input high voltage (\overline{WC} , E2, E1, E0) ⁽⁶⁾	-	$0.7 V_{CC}$	$V_{CC}+0.6$	V
V_{OL}	Output low voltage	$I_{OL} = 2.1 mA$, $V_{CC} = 2.5 V$ or $I_{OL} = 3 mA$, $V_{CC} = 5.5 V$	-	0.4	V

1. For devices identified with process letter K or T.
2. Characterized value, not tested in production.
3. The device is not selected after power-up, after a Read instruction (after the Stop condition), or after the completion of the internal write cycle t_W (t_W is triggered by the correct decoding of a Write instruction).
4. Previous products (identified with process letter P) offer $ICC1(max) = 5 \mu A$
5. E_i inputs should be tied to V_{SS} (see Section 2.3).
6. E_i inputs should be tied to V_{CC} (see Section 2.3).

Table 17. DC characteristics (M24C64-R device grade 6)

Symbol	Parameter	Test conditions ⁽¹⁾ (in addition to those in Table 10)	Min.	Max.	Unit
I_{LI}	Input leakage current (E0, E1, E2, SCL, SDA)	$V_{IN} = V_{SS}$ or V_{CC} , device in Standby mode	-	± 2	μA
I_{LO}	Output leakage current	SDA in Hi-Z, external voltage applied on SDA: V_{SS} or V_{CC}	-	± 2	μA
I_{CC}	Supply current (Read)	$V_{CC} = 1.8 V$, $f_c = 400 kHz$	-	0.8	mA
		$f_c = 1 MHz$ ⁽²⁾	-	2.5	mA
I_{CC0}	Supply current (Write) ⁽³⁾	During t_W $1.8 V \leq V_{CC} < 2.5 V$	-	1.5 ⁽⁴⁾	mA
I_{CC1}	Standby supply current	Device not selected ⁽⁵⁾ , $V_{IN} = V_{SS}$ or V_{CC} , $V_{CC} = 1.8 V$	-	1	μA
V_{IL}	Input low voltage (SCL, SDA) ⁽⁶⁾	$1.8 V \leq V_{CC} < 2.5 V$	-0.45	$0.25 V_{CC}$	V
V_{IH}	Input high voltage (SCL, SDA)	$1.8 V \leq V_{CC} < 2.5 V$	$0.75 V_{CC}$	6.5	V
	Input high voltage (WC) ⁽⁷⁾	$1.8 V \leq V_{CC} < 2.5 V$	$0.75 V_{CC}$	$V_{CC} + 0.6$	V
V_{OL}	Output low voltage	$I_{OL} = 1 mA$, $V_{CC} = 1.8 V$ ⁽⁸⁾	-	0.2	V

1. If the application uses the voltage range R device with $2.5 V < V_{CC} < 5.5 V$ and $-40^\circ C < T_A < +85^\circ C$, please refer to [Table 16](#) instead of this table.
2. Only for devices operating at $f_c \text{ max} = 1 MHz$ (see note (1) in [Table 20](#)).
3. For devices identified with process letter K or T
4. Characterized value, not tested in production.
5. The device is not selected after power-up, after a Read instruction (after the Stop condition), or after the completion of the internal write cycle t_W (t_W is triggered by the correct decoding of a Write instruction).
6. E_i inputs should be tied to V_{SS} (see [Section 2.3](#)).
7. E_i inputs should be tied to V_{CC} (see [Section 2.3](#)).
8. $I_{OL} = 0.7 mA$ for devices identified by process letter P.

Table 18. DC characteristics (M24C64-F, M24C64-DF, device grade 6)

Symbol	Parameter	Test conditions ⁽¹⁾ (in addition to those in Table 11)	Min.	Max.	Unit
I_{LI}	Input leakage current (E1, E2, SCL, SDA)	$V_{IN} = V_{SS}$ or V_{CC} device in Standby mode	-	± 2	μA
I_{LO}	Output leakage current	SDA in Hi-Z, external voltage applied on SDA: V_{SS} or V_{CC}	-	± 2	μA
I_{CC}	Supply current (Read)	$V_{CC} = 1.6 V$ or $1.7 V$, $f_C = 400 kHz$	-	0.8	mA
		$f_C = 1 MHz$ ⁽²⁾	-	2.5	
I_{CC0}	Supply current (Write)	During t_W , $V_{CC} < 2.5 V$	-	1.5 ⁽³⁾	mA
I_{CC1}	Standby supply current	Device not selected ⁽⁴⁾ , $V_{IN} = V_{SS}$ or V_{CC} , $V_{CC} = 1.6 V$ or $1.7 V$	-	1	μA
V_{IL}	Input low voltage (SCL, SDA, \overline{WC} , E_i) ⁽⁵⁾	$V_{CC} < 2.5 V$	-0.45	$0.25 V_{CC}$	V
V_{IH}	Input high voltage (SCL, SDA)	$V_{CC} < 2.5 V$	$0.75 V_{CC}$	6.5	V
	Input high voltage (\overline{WC} , E2, E1, E0) ⁽⁶⁾	$V_{CC} < 2.5 V$	$0.75 V_{CC}$	$V_{CC} + 0.6$	
V_{OL}	Output low voltage	$I_{OL} = 1mA$, $V_{CC} = 1.6 V$ or $1.7 V$	-	0.2	V

1. If the application uses the voltage range F device with $2.5 V < V_{CC} < 5.5 V$ and $-40^\circ C < T_A < +85^\circ C$, please refer to [Table 16](#) instead of this table.
2. Only for devices identified by process letter K or T (see [Table 20](#)).
3. Characterized value, not tested in production.
4. The device is not selected after power-up, after a Read instruction (after the Stop condition), or after the completion of the internal write cycle t_W (t_W is triggered by the correct decoding of a Write instruction).
5. E_i inputs should be tied to V_{SS} (see [Section 2.3](#)).
6. E_i inputs should be tied to V_{CC} (see [Section 2.3](#)).

Table 19. 400 kHz AC characteristics

Symbol	Alt.	Parameter	Min.	Max.	Unit
f_C	f_{SCL}	Clock frequency	-	400	kHz
t_{CHCL}	t_{HIGH}	Clock pulse width high	600	-	ns
t_{CLCH}	t_{LOW}	Clock pulse width low	1300	-	ns
$t_{QL1QL2}^{(1)}$	t_F	SDA (out) fall time	20 ⁽²⁾	300	ns
t_{XH1XH2}	t_R	Input signal rise time	(3)	(3)	ns
t_{XL1XL2}	t_F	Input signal fall time	(3)	(3)	ns
t_{DXCH}	$t_{SU:DAT}$	Data in set up time	100	-	ns
t_{CLDX}	$t_{HD:DAT}$	Data in hold time	0	-	ns
$t_{CLQX}^{(4)}$	t_{DH}	Data out hold time	50 ⁽⁵⁾	-	ns
$t_{CLQV}^{(6)}$	t_{AA}	Clock low to next data valid (access time)	-	900	ns
t_{CHDL}	$t_{SU:STA}$	Start condition setup time	600	-	ns
t_{DLCL}	$t_{HD:STA}$	Start condition hold time	600	-	ns
t_{CHDH}	$t_{SU:STO}$	Stop condition set up time	600	-	ns
t_{DHDL}	t_{BUF}	Time between Stop condition and next Start condition	1300	-	ns
$t_{WLDL}^{(7)(1)}$	$t_{SU:WC}$	\overline{WC} set up time (before the Start condition)	0	-	μ s
$t_{DHWL}^{(8)(1)}$	$t_{HD:WC}$	\overline{WC} hold time (after the Stop condition)	1	-	μ s
t_W	t_{WR}	Internal Write cycle duration	-	5	ms
$t_{NS}^{(1)}$	-	Pulse width ignored (input filter on SCL and SDA) - single glitch	-	50 ⁽⁹⁾	ns

1. Characterized only, not tested in production.
2. With $C_L = 10$ pF.
3. There is no min. or max. values for the input signal rise and fall times. It is however recommended by the I²C specification that the input signal rise and fall times be more than 20 ns and less than 300 ns when $f_C < 400$ kHz.
4. To avoid spurious Start and Stop conditions, a minimum delay is placed between SCL=1 and the falling or rising edge of SDA.
5. The previous products were specified with t_{CLQX} longer than 50 ns. it should be noted that any t_{CLQX} value longer than 50ns offers a safe margin when compared to the I2C-bus specification recommendations.
6. t_{CLOV} is the time (from the falling edge of SCL) required by the SDA bus line to reach either $0.3V_{CC}$ or $0.7V_{CC}$, assuming that $R_{bus} \times C_{bus}$ time constant is within the values specified in [Figure 15](#).
7. $\overline{WC}=0$ set up time condition to enable the execution of a WRITE command.
8. $\overline{WC}=0$ hold time condition to enable the execution of a WRITE command.
9. The previous products were specified with t_{NS} longer than 50ns. it should be noted that the $t_{NS}(\max) = 50$ ns is the value defined by the I2C-bus specification.

Table 20. 1 MHz AC characteristics

Symbol	Alt.	Parameter ⁽¹⁾	Min.	Max.	Unit
f_C	f_{SCL}	Clock frequency	0	1	MHz
t_{CHCL}	t_{HIGH}	Clock pulse width high	260	-	ns
t_{CLCH}	t_{LOW}	Clock pulse width low	500	-	ns
t_{XH1XH2}	t_R	Input signal rise time	(2)	(2)	ns
t_{XL1XL2}	t_F	Input signal fall time	(2)	(2)	ns
$t_{QL1QL2}^{(3)}$	t_F	SDA (out) fall time	20 ⁽⁴⁾	120	ns
t_{DXCH}	$t_{SU:DAT}$	Data in setup time	50	-	ns
t_{CLDX}	$t_{HD:DAT}$	Data in hold time	0	-	ns
$t_{CLQX}^{(5)}$	t_{DH}	Data out hold time	50 ⁽⁶⁾	-	ns
$t_{CLQV}^{(7)}$	t_{AA}	Clock low to next data valid (access time)	-	450	ns
t_{CHDL}	$t_{SU:STA}$	Start condition setup time	250	-	ns
t_{DLCL}	$t_{HD:STA}$	Start condition hold time	250	-	ns
t_{CHDH}	$t_{SU:STO}$	Stop condition setup time	250	-	ns
t_{DHDL}	t_{BUF}	Time between Stop condition and next Start condition	500	-	ns
$t_{WLDL}^{(8)(3)}$	$t_{SU:WC}$	\overline{WC} set up time (before the Start condition)	0	-	μ s
$t_{DHWL}^{(9)(3)}$	$t_{HD:WC}$	\overline{WC} hold time (after the Stop condition)	1	-	μ s
t_W	t_{WR}	Write time	-	5	ms
$t_{NS}^{(3)}$	-	Pulse width ignored (input filter on SCL and SDA)	-	50 ⁽¹⁰⁾	ns

1. Only for devices identified by the process letter K or T (devices qualified at 1 MHz).
2. There is no min. or max. values for the input signal rise and fall times. It is however recommended by the I²C specification that the input signal rise and fall times be less than 120 ns when $f_C < 1$ MHz.
3. Characterized only, not tested in production.
4. With $C_L = 10$ pF.
5. To avoid spurious Start and Stop conditions, a minimum delay is placed between SCL=1 and the falling or rising edge of SDA.
6. The previous products were specified with t_{CLQX} longer than 50 ns. it should be noted that any t_{CLQX} value longer than 50ns offers a safe margin when compared to the I2C-bus specification recommendations.
7. t_{CLQV} is the time (from the falling edge of SCL) required by the SDA bus line to reach either $0.3 V_{CC}$ or $0.7 V_{CC}$, assuming that the $R_{bus} \times C_{bus}$ time constant is within the values specified in [Figure 16](#).
8. $\overline{WC}=0$ set up time condition to enable the execution of a WRITE command.
9. $\overline{WC}=0$ hold time condition to enable the execution of a WRITE command.
10. The previous products were specified with t_{NS} longer than 50 ns. it should be noted that the I2C-bus specification recommends a t_{NS} value longer than 50ns.

Figure 15. Maximum R_{bus} value versus bus parasitic capacitance (C_{bus}) for an I2C bus at maximum frequency $f_C = 400$ kHz



Figure 16. Maximum R_{bus} value versus bus parasitic capacitance (C_{bus}) for an I2C bus at maximum frequency $f_C = 1$ MHz



Figure 17. AC waveforms



9 Package information

In order to meet environmental requirements, ST offers these devices in different grades of ECOPACK® packages, depending on their level of environmental compliance. ECOPACK® specifications, grade definitions and product status are available at: www.st.com. ECOPACK® is an ST trademark.

For die information concerning the M24C64 delivered in unsawn wafer, please contact your nearest ST Sales Office.

9.1 UFDFPN5 (DFN5) package information

Figure 18. UFDFPN5 – 1.7x1.4 mm, 0.55 mm thickness, ultra thin fine pitch dual flat package, no lead - package outline



1. On the bottom side, pin 1 is identified by the specific pad shape and, on the top side, pin 1 is defined from the orientation of the marking: when reading the marking, pin 1 is below the upper left package corner.

Table 21. UFDFPN5 - 1.7 × 1.4 mm, 0.55 mm thickness, ultra thin fine pitch dual flat package, no lead - package mechanical data

Symbol	millimeters			inches ⁽¹⁾		
	Min	Typ	Max	Min	Typ	Max
A	0.500	0.550	0.600	0.0197	0.0217	0.0236
A1	0.000	-	0.050	0.0000	-	0.0020
b ⁽²⁾	0.175	0.200	0.225	0.0069	0.0079	0.0089
D	1.600	1.700	1.800	0.0630	0.0669	0.0709
D1	1.400	1.500	1.600	0.0551	0.0591	0.0630
E	1.300	1.400	1.500	0.0512	0.0551	0.0591
E1	0.175	0.200	0.225	0.0069	0.0079	0.0089
X	-	0.200	-	-	0.0079	-

Table 21. UFDFPN5 - 1.7 × 1.4 mm, 0.55 mm thickness, ultra thin fine pitch dual flat package, no lead - package mechanical data (continued)

Symbol	millimeters			inches ⁽¹⁾		
	Min	Typ	Max	Min	Typ	Max
Y	-	0.200	-	-	0.0079	-
e	-	0.400	-	-	0.0157	-
L	0.500	0.550	0.600	0.0197	0.0217	0.0236
L1	-	0.100	-	-	0.0039	-
k	-	0.400	-	-	0.0157	-

1. Values in inches are converted from mm and rounded to 4 decimal digits.
2. Dimension b applies to plated terminal and is measured between 0.15 and 0.30mm from the terminal tip.

Figure 19. UFDFPN5 - 5-lead, 1.7 × 1.4 mm, 0.55 mm thickness, ultra thin fine pitch dual flat package, no lead recommended footprint

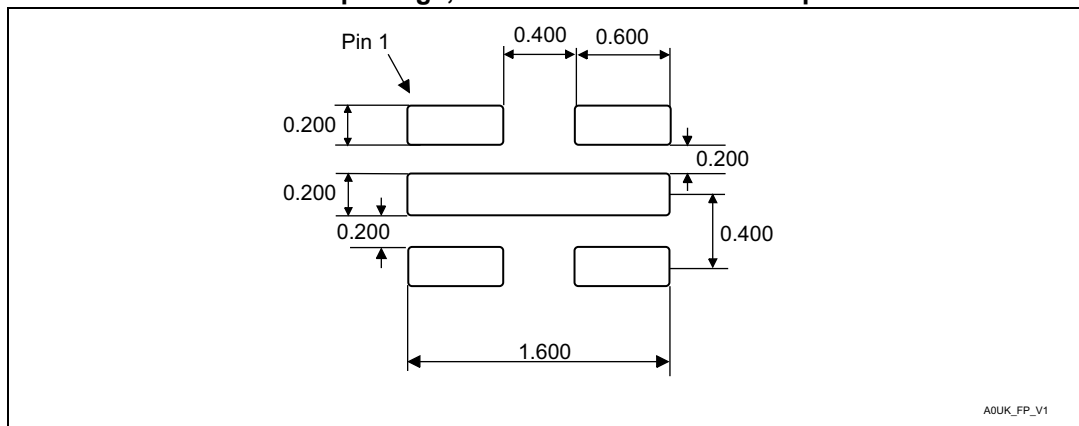

1. Dimensions are expressed in millimeters.

9.2 UFDFPN8 (DFN8) package information

Figure 20. UFDFPN8 – 2x3 mm, 0.55 thickness, ultra thin fine pitch dual flat package, no lead - package outline



1. Drawing is not to scale.
2. The central pad (the area E2 by D2 in the above illustration) must be either connected to V_{SS} or left floating (not connected) in the end application.

Table 22. UFDFPN8 – 2x3 mm, 0.55 thickness, ultra thin fine pitch dual flat package, no lead - package mechanical data

Symbol	millimeters			inches ⁽¹⁾		
	Min	Typ	Max	Min	Typ	Max
A	0.450	0.550	0.600	0.0177	0.0217	0.0236
A1	0.000	0.020	0.050	0.0000	0.0008	0.0020
b	0.200	0.250	0.300	0.0079	0.0098	0.0118
D	1.900	2.000	2.100	0.0748	0.0787	0.0827
D2	1.200	-	1.600	0.0472	-	0.0630
E	2.900	3.000	3.100	0.1142	0.1181	0.1220
E2	1.200	-	1.600	0.0472	-	0.0630
e	-	0.500	-	-	0.0197	-
K	0.300	-	-	0.0118	-	-
L	0.300	-	0.500	0.0118	-	0.0197
L1	-	-	0.150	-	-	0.0059
L3	0.300	-	-	0.0118	-	-
eee ⁽²⁾	0.080	-	-	0.0031	-	-

1. Values in inches are converted from mm and rounded to four decimal digits.
2. Applied for exposed die paddle and terminals. Exclude embedding part of exposed die paddle from measuring.

9.3 TSSOP8 package information

Figure 21. TSSOP8 – 3x4.4 mm, 0.65 mm pitch, 8-lead thin shrink small outline, package outline



1. Drawing is not to scale.

Table 23. TSSOP8 – 3 x 4.4 mm, 0.65 mm pitch, 8-lead thin shrink small outline, package mechanical data

Symbol	millimeters			inches ⁽¹⁾		
	Min.	Typ.	Max.	Min.	Typ.	Max.
A	-	-	1.200	-	-	0.0472
A1	0.050	-	0.150	0.0020	-	0.0059
A2	0.800	1.000	1.050	0.0315	0.0394	0.0413
b	0.190	-	0.300	0.0075	-	0.0118
c	0.090	-	0.200	0.0035	-	0.0079
CP	-	-	0.100	-	-	0.0039
D	2.900	3.000	3.100	0.1142	0.1181	0.1220
e	-	0.650	-	-	0.0256	-
E	6.200	6.400	6.600	0.2441	0.2520	0.2598
E1	4.300	4.400	4.500	0.1693	0.1732	0.1772
L	0.450	0.600	0.750	0.0177	0.0236	0.0295
L1	-	1.000	-	-	0.0394	-
α	0°	-	8°	0°	-	8°

1. Values in inches are converted from mm and rounded to four decimal digits.

9.4 SO8N package information

Figure 22. SO8N – 3.9x4.9 mm, 8-lead plastic small outline, 150 mils body width, package outline



1. Drawing is not to scale.

Table 24. SO8N – 3.9x4.9 mm, 8-lead plastic small outline, 150 mils body width, package mechanical data

Symbol	millimeters			inches ⁽¹⁾		
	Min.	Typ.	Max.	Min.	Typ.	Max.
A	-	-	1.750	-	-	0.0689
A1	0.100	-	0.250	0.0039	-	0.0098
A2	1.250	-	-	0.0492	-	-
b	0.280	-	0.480	0.0110	-	0.0189
c	0.170	-	0.230	0.0067	-	0.0091
D	4.800	4.900	5.000	0.1890	0.1929	0.1969
E	5.800	6.000	6.200	0.2283	0.2362	0.2441
E1	3.800	3.900	4.000	0.1496	0.1535	0.1575
e	-	1.270	-	-	0.0500	-
h	0.250	-	0.500	0.0098	-	0.0197
k	0°	-	8°	0°	-	8°
L	0.400	-	1.270	0.0157	-	0.0500
L1	-	1.040	-	-	0.0409	-
ccc	-	-	0.100	-	-	0.0039

1. Values in inches are converted from mm and rounded to four decimal digits.

Figure 23. SO8N – 3.9x4.9 mm, 8-lead plastic small outline, 150 mils body width, package recommended footprint



1. Dimensions are expressed in millimeters.

9.5 PDIP8 package information

Figure 24. PDIP8 – 8-pin plastic DIP, 0.25 mm lead frame, package outline



1. Drawing is not to scale.
2. Not recommended for new designs.

Table 25. PDIP8 – 8-pin plastic DIP, 0.25 mm lead frame, package mechanical data

Symbol	millimeters			inches ⁽¹⁾		
	Min.	Typ.	Max.	Min.	Typ.	Max.
A	-	-	5.33	-	-	0.2098
A1	0.38	-	-	0.0150	-	-
A2	2.92	3.30	4.95	0.1150	0.1299	0.1949
b	0.36	0.46	0.56	0.0142	0.0181	0.0220
b2	1.14	1.52	1.78	0.0449	0.0598	0.0701
c	0.20	0.25	0.36	0.0079	0.0098	0.0142
D	9.02	9.27	10.16	0.3551	0.3650	0.4000
E	7.62	7.87	8.26	0.3000	0.3098	0.3252
E1	6.10	6.35	7.11	0.2402	0.2500	0.2799
e	-	2.54	-	-	0.1000	-
eA	-	7.62	-	-	0.3000	-
eB	-	-	10.92	-	-	0.4299
L	2.92	3.30	3.81	0.1150	0.1299	0.1500

1. Values in inches are converted from mm and rounded to four decimal digits.

9.6 WLCSP4 ultra thin package information

Figure 25. Ultra Thin WLCSP- 4-bump, 0.795 x 0.674 mm, wafer level chip scale package outline

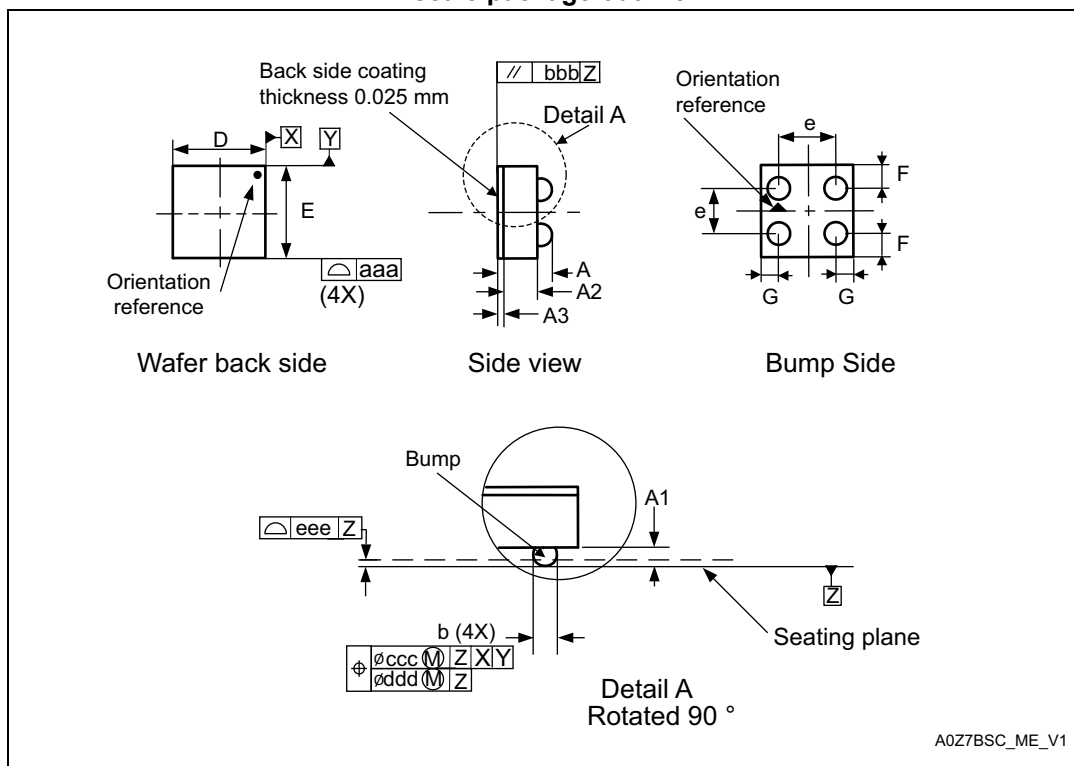

1. Drawing is not to scale.
2. Primary datum Z and seating plane are defined by the spherical crowns of the bump.

Table 26. Ultra Thin WLCSP- 4-bump, 0.795 x 0.674 mm, wafer level chip scale package mechanical data

Symbol	millimeters			inches ⁽¹⁾		
	Min	Typ	Max	Min	Typ	Max
A	0.285	0.315	0.345	0.0112	0.0124	0.0136
A1	-	0.115	-	-	0.0045	-
A2	-	0.175	-	-	0.0069	-
A3 (BSC)	-	0.025	-	-	0.0010	-
b ^{(2) (3)}	-	0.160	-	-	0.0063	-
D	-	0.795	0.815	-	0.0313	0.0321
E	-	0.674	0.694	-	0.0265	0.0273
e	-	0.400	-	-	0.0157	-
F	-	0.137	-	-	0.0054	-
G	-	0.198	-	-	0.0078	-
aaa	-	-	0.110	-	-	0.0043

Table 26. Ultra Thin WLCSP- 4-bump, 0.795 x 0.674 mm, wafer level chip scale package mechanical data (continued)

bbb	-	-	0.110	-	-	0.0043
ccc	-	-	0.110	-	-	0.0043
ddd	-	-	0.060	-	-	0.0024
eee	-	-	0.060	-	-	0.0024

1. Values in inches are converted from mm and rounded to 4 decimal digits.
2. Dimension is measured at the maximum bump diameter parallel to primary datum Z.
3. Primary datum Z and seating plane are defined by the spherical crowns of the bump.

Figure 26. Thin WLCSP- 4-bump, 0.795 x 0.674 mm, wafer level chip scale package recommended footprint

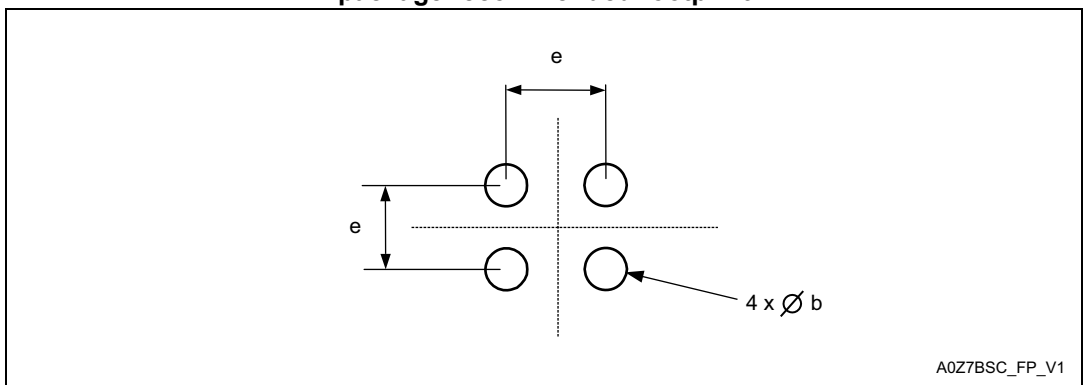

1. Dimensions are expressed in millimeters.

9.7 WLCSP5 package information

Figure 27. WLCSP 5-bump, 0.959 x 1.073 mm, 0.4 mm pitch wafer level chip scale (M24C64-FCS6TP/K)- package outline



1. Drawing is not to scale.
2. The index on the wafer back side (circle) is above the index of the bump side (triangle/arrow).

Table 27. WLCSP- 5-bump, 0.959 x 1.073 mm, 0.4 mm pitch wafer level chip scale package mechanical data

Symbol	millimeters			inches ⁽¹⁾		
	Min	Typ	Max	Min	Typ	Max
A	0.455	0.545	0.645	0.0179	0.0215	0.0254
A1	-	0.190	-	-	0.0075	-
A2	-	0.355	-	-	0.0140	-
b ⁽²⁾	-	0.270	-	-	0.0106	-
D	-	0.959	1.074	-	0.0378	0.0423
E	-	1.073	1.168	-	0.0422	0.0460
e	-	0.693	-	-	0.0273	-
e1	-	0.400	-	-	0.0157	-
e2	-	0.3465	-	-	0.0136	-
F	-	0.280	-	-	0.0110	-
G	-	0.190	-	-	0.0075	-
aaa	-	-	0.110	-	-	0.0043
bbb	-	-	0.110	-	-	0.0043

1. Values in inches are converted from mm and rounded to 4 decimal digits.
2. Dimension is measured at the maximum bump diameter parallel to primary datum Z.

Figure 28. WLCSP - 5-bump, 0.959 x 1.073 mm, 0.4 mm pitch wafer level chip scale recommended footprint



1. Dimensions are expressed in millimeters.

9.8 WLCSP8 thin package information

Figure 29. Thin WLCSP- 8-bump, 1.073 x 0.959 mm, wafer level chip scale package outline



1. Drawing is not to scale.
2. Primary datum Z and seating plane are defined by the spherical crowns of the bump.

Table 28. Thin WLCSP- 8-bump, 1.073 x 0.959 mm, wafer level chip scale package mechanical data

Symbol	millimeters			inches ⁽¹⁾		
	Min	Typ	Max	Min	Typ	Max
A	0.300	0.315	0.330	0.0118	0.0124	0.0130
A1	-	0.115	-	-	0.0045	-
A2	-	0.200	-	-	0.0079	-
b ⁽²⁾	-	0.160	-	-	0.0063	-
D	-	1.073	1.093	-	0.0422	0.0430
E	-	0.959	0.979	-	0.0378	0.0385
e	-	0.693	-	-	0.0273	-
e1	-	0.800	-	-	0.0315	-
e2	-	0.400	-	-	0.0157	-
F	-	0.133	-	-	0.0052	-
G	-	0.137	-	-	0.0054	-
aaa	-	-	0.110	-	-	0.0043
bbb	-	-	0.110	-	-	0.0043
ccc	-	-	0.110	-	-	0.0043
ddd	-	-	0.060	-	-	0.0024
eee	-	-	0.060	-	-	0.0024

1. Values in inches are converted from mm and rounded to 4 decimal digits.
2. Dimension is measured at the maximum bump diameter parallel to primary datum Z.

Figure 30. Thin WLCSP- 8-bump, 1.073 x 0.959 mm, wafer level chip scale package recommended footprint



1. Dimensions are expressed in millimeters.

10 Ordering information

Table 29. Ordering information scheme

Example:	M24C64	-D	W	MC	6	T	P	/P	F
Device type									
M24 = I ² C serial access EEPROM									
Device function									
C64 = 64 Kbit (8192 x 8 bit)									
Device family									
Blank = Without Identification page									
D = With Identification page									
Operating voltage									
W = VCC = 2.5 V to 5.5 V									
R = VCC = 1.8 V to 5.5 V									
F = VCC = 1.7 V to 5.5 V									
Package									
BN = PDIP8 ⁽¹⁾									
MN = SO8 (150 mil width) ⁽²⁾									
DW = TSSOP8 (169 mil width) ⁽²⁾									
MC = UFDFPN8 (DFN8) ⁽²⁾									
MH = UFDFPN5 (DFN5) ⁽²⁾									
CS = 5-bump WLCSP ⁽²⁾									
CT = 8-bump WLCSP ⁽²⁾									
CU = 4-bump WLCSP									
Device grade									
6 = Industrial: device tested with standard test flow over -40 to 85 °C									
Option									
T = Tape and reel packing									
blank = tube packing									
Plating technology									
P or G = ECOPACK2®									
Process⁽³⁾ or Packing option									
/P or /K or /T = Manufacturing technology code									
/12 = Packing 12 mm tape									
Option									
Blank = No Back Side Coating									
F = Back Side Coating (WLCSP height = 0.345mm)									

1. RoHS-compliant (ECOPACK1®)
2. ECOPACK2® ((RoHS compliant and free of brominated, chlorinated and antimony oxide flame retardants))
3. The process letter is used only when ordering WLCSP packages, the process letter is not specified when ordering any other package. These process letters appear on the device package (marking) and on the shipment box. Please contact your nearest ST Sales Office for further information.

Table 30. Ordering information scheme (unsawn wafer)^{(1) (2)}

Example:	M24C64	-	F	T	W	20	I	/90
Device type								
M24 = I ² C serial access EEPROM								
Device function								
C64 = 64 Kbit (8192 x 8 bit)								
Operating voltage								
F = V _{CC} = 1.7 V to 5.5 V								
Process								
T = F8H+								
Delivery form								
W = Wafer (bare die)								
Wafer thickness								
20 = Non-backlapped wafer								
Wafer testing								
I = Inkless test								
Device grade								
90 = -40°C to 85°C								

1. For all information concerning the M24C64 delivered in unsawn wafer, please contact your nearest ST Sales Office.
2. Unsawn wafer in preview.

Engineering samples

Parts marked as ES or E are not yet qualified and therefore not approved for use in production. ST is not responsible for any consequences deriving from such use. In no event, will ST be liable for the customer using of these engineering samples in production. ST's quality department must be contacted prior to any decision to use these engineering samples to run qualification activity.

11 Revision history

Table 31. Document revision history

Date	Revision	Changes
14-Mar-2011	22	Updated information concerning E2, E1, E0 for the WLCSP package: <ul style="list-style-type: none"> – note under Figure 3: UFDFPN5 package connections – comment under Figure 7: Chip enable inputs connection – note 3 under Table 2: Device select code
07-Apr-2011	23	Updated MLP8 package data and Section 10: Part numbering Added footnote (a) in Section 4.5: Memory addressing .
18-May-2011	24	Updated: <ul style="list-style-type: none"> – Figure 3: UFDFPN5 package connections – Table 6: Absolute maximum ratings – Small text changes Added: <ul style="list-style-type: none"> – Figure 12: Memory cell characteristics
08-Sep-2011	25	Updated: <ul style="list-style-type: none"> – Table 22: UFDFPN8 (MLP8) – 8-lead ultra thin fine pitch dual flat no lead, 2 x 3 mm, data – Figure 16: Maximum R_{bus} value versus bus parasitic capacitance C_{bus} for an I²C bus at maximum frequency $f_C = 1\text{MHz}$ – Figure 6: I2C Fast mode Plus ($f_C = 1\text{MHz}$): maximum R_{bus} value versus bus parasitic capacitance (C_{bus}). Added t_{WLDL} and t_{DHWLH} in: <ul style="list-style-type: none"> – Table 17: 400 kHz AC characteristics – Table 18: 1 MHz AC characteristics – Figure : Minor text changes.
16-Dec-2011	26	Updated A dimension in Table 25: WLCSP- 5-bump, 0.959 x 1.073 mm, 0.4 mm pitch wafer level chip scale package mechanical data .

Table 31. Document revision history (continued)

Date	Revision	Changes
28-Aug-2012	27	<p>Datasheet split into:</p> <ul style="list-style-type: none"> – M24C64-DF, M24C64-W, M24C64-R, M24C64-F (this datasheet) for standard products (range 6), – M24C64-125 datasheet for automotive products (range 3). <p>Added 8-bump thin WLCSP.</p> <p>Updated single supply voltage and number of Write cycles on cover page.</p> <p>Updated Section 2.1: Serial Clock (SCL) and Section 2.2: Serial Data (SDA).</p> <p>Updated Figure 8: Block diagram.</p> <p>Added Section 4.5: Device addressing.</p> <p>Section 5.1: Write operations move to Section 5: Instructions and updated.</p> <p>Moved Figure 10: Write mode sequences with WC = 0 (data write enabled) to Section 5.1.1: Byte Write.</p> <p>Section 5.1.2: Page Write: changed address bits to A15/A5 and updated Figure 11.</p> <p>Case of locked Write identification Page removed from Section 5.1.4: Lock Identification Page (M24C64-D only).</p> <p>Updated Section 5.1.5: ECC (Error Correction Code) and Write cycling and move Figure 12: Write cycle polling flowchart using ACK to Section 5.1.6: Minimizing Write delays by polling on ACK.</p> <p>Added note 1 in Table 7: Operating conditions (voltage range W) and Table 8: Operating conditions (voltage range R).</p> <p>Added Table 12 and updated Table 13: Memory cell data retention.</p> <p>Removed note 2 in Table 17: 400 kHz AC characteristics for tQL1QL2, tWLDL, tDWHH, and tNS.</p> <p>Table 27: Ordering information scheme: removed ambient operating temperature for device grade 5 and added Note 3. to MLP8 and WLCSP packages.</p>
18-Nov-2013	28	<p>Added text in Chapter 5.2.2: Current Address Read</p> <p>Updated note ⁽¹⁾ under Table 6: Absolute maximum ratings.</p> <p>Removed note ⁽³⁾ in Table 3: Device select code.</p> <p>Updated notes below Table 14: DC characteristics (M24C64-W, device grade 6) and Table 15: DC characteristics (M24C64-R device grade 6)</p> <p>Renamed Figure 19 and Table 25.</p> <p>Updated captions above Figure 26 and Figure 24.</p>

Table 31. Document revision history (continued)

Date	Revision	Changes
21-Jul-2014	29	<p>Updated Figure 3, Figure 6, Table 15, Table 9, Table 17, Table 18 and Table 27.</p> <p>Updated ECOPACK info on front page.</p> <p>Updated notes:</p> <ul style="list-style-type: none"> – (1) on Table 7, Table 8, Table 14, Table 18 – (2) merged with (3) on Table 15 – (8) on Table 15 – (2) on Table 16 – (3) on Table 27 <p>Added:</p> <ul style="list-style-type: none"> – note (1) on Table 9 <p>Added:</p> <ul style="list-style-type: none"> – supply voltage level specification on Cover page. – package UDFPN5 on Cover page – Table 18 and Figure 18 related to UDFPN5 package. – Note (1) on Section 5.1.5
12-Nov-2014	30	<p>Added:</p> <ul style="list-style-type: none"> – note 2 on Table 14 – note 2 on DW, MC and CS package on Table 27 – note 1 on BN package on Table 27 – Figure 3 <p>Updated:</p> <ul style="list-style-type: none"> – Section 1: Description – Chapter 5.1.5 – note 3 on Table 6 – note 1 on Table 9 – note 1 on Table 12 – note 1 on Table 13 – I_{CC0} max value and note 5 on Table 14 – I_{CC0} max value on Table 15 – I_{CC0} max value on Table 16 – note 2 on Table 27
30-Jul-2015	31	<p>Added WLCSP package.</p> <p>Updated Table 27.</p>
18-Feb-2016	32	<p>Updated Figure 4, Figure 18, Table 19 and added Table 2</p>
22-June-2016	33	<p>Added Reference to unsawn wafer inside cover page and added Table 28: Ordering information scheme (unsawn wafer)</p>

Table 31. Document revision history (continued)

Date	Revision	Changes
13-Sep-2017	34	<p>Added reference to DFN8 and DFN5 in: cover page figure, Figure 3: UFDFPN5 (DFN5) package connections, Section 9.1: UFDFPN5 (DFN5) package information, Section 9.2: UFDFPN8 (DFN8) package information and Table 29: Ordering information scheme.</p> <p>Added Figure 19: UFDFPN5 - 5-lead, 1.7 × 1.4 mm, 0.55 mm thickness, ultra thin fine pitch dual flat package, no lead recommended footprint.</p> <p>Updated Section Table 28.: Thin WLCSP- 8-bump, 1.073 x 0.959 mm, wafer level chip scale package mechanical data</p>
16-Nov-2017	35	Updated Table 29: Ordering information scheme
14-Mar-2018	36	<p>Added Table 3: WLCSP 5-bump signals vs. bump position, Table 4: WLCSP 8-bump signals vs bump position</p> <p>Updated Figure 6: WLCSP 8-bump thin connections (M24C64-DFCT6TP/K)</p>

IMPORTANT NOTICE – PLEASE READ CAREFULLY

STMicroelectronics NV and its subsidiaries ("ST") reserve the right to make changes, corrections, enhancements, modifications, and improvements to ST products and/or to this document at any time without notice. Purchasers should obtain the latest relevant information on ST products before placing orders. ST products are sold pursuant to ST's terms and conditions of sale in place at the time of order acknowledgement.

Purchasers are solely responsible for the choice, selection, and use of ST products and ST assumes no liability for application assistance or the design of Purchasers' products.

No license, express or implied, to any intellectual property right is granted by ST herein.

Resale of ST products with provisions different from the information set forth herein shall void any warranty granted by ST for such product.

ST and the ST logo are trademarks of ST. All other product or service names are the property of their respective owners.

Information in this document supersedes and replaces information previously supplied in any prior versions of this document.

© 2018 STMicroelectronics – All rights reserved

Mouser Electronics

Authorized Distributor

Click to View Pricing, Inventory, Delivery & Lifecycle Information:

STMicroelectronics:

[M24C64-WMN6P](#) [M24C64-WDW6TP](#) [M24C64-FCS6TP/K](#) [M24C64-FDW6TP](#) [M24C64-RDW6TP](#) [M24C64-RMN6P](#)
[M24C64-RMN6TP](#) [M24C64-WMN6TP](#) [M24C64-DFDW6TP](#) [M24C64-DFMC6TG](#) [M24C64-DFMN6TP](#) [M24C64-](#)
[FMC6TG](#) [M24C64-DFCT6TP/K](#) [M24C64-FMN6TP](#) [M24C64-FCU6TP/TF](#) [M24C64-FMH6TG](#)